

UMC2NT1G, NSVUMC2NT1G, UMC3NT1G, NSVUMC3NT1G, UMC5NT1G, NSVUMC5NT2G

Dual Common Base-Collector Bias Resistor Transistors

NPN and PNP Silicon Surface Mount Transistors with Monolithic Bias Resistor Network

The Bias Resistor Transistor (BRT) contains a single transistor with a monolithic bias network consisting of two resistors; a series base resistor and a base-emitter resistor. These digital transistors are designed to replace a single device and its external resistor bias network. The BRT eliminates these individual components by integrating them into a single device. In the UMC2NT1G series, two complementary BRT devices are housed in the SOT-353 package which is ideal for low power surface mount applications where board space is at a premium.

Features

- Simplifies Circuit Design
- Reduces Board Space
- Reduces Component Count
- Available in 8 mm, 7 inch/3000 Unit Tape and Reel
- AEC-Q101 Qualified and PPAP Capable
- NSV Prefix for Automotive and Other Applications Requiring Unique Site and Control Change Requirements
- These Devices are Pb-Free, Halogen Free/BFR Free and are RoHS Compliant*

MAXIMUM RATINGS ($T_A = 25^\circ\text{C}$ unless otherwise noted, common for Q_1 and Q_2 , - minus sign for Q_1 (PNP) omitted)

| Rating | Symbol | Value | Unit |
|---------------------------|-----------|-------|------|
| Collector-Base Voltage | V_{CBO} | 50 | Vdc |
| Collector-Emitter Voltage | V_{CEO} | 50 | Vdc |
| Collector Current | I_C | 100 | mAdc |

Stresses exceeding Maximum Ratings may damage the device. Maximum Ratings are stress ratings only. Functional operation above the Recommended Operating Conditions is not implied. Extended exposure to stresses above the Recommended Operating Conditions may affect device reliability.

*For additional information on our Pb-Free strategy and soldering details, please download the ON Semiconductor Soldering and Mounting Techniques Reference Manual, SOLDERRM/D.



ON Semiconductor®

<http://onsemi.com>



SC-88A/SOT-353
CASE 419A
STYLE 6



MARKING DIAGRAM

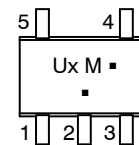

Ux = Device Marking
x = 2, 3 or 5
M = Date Code
▪ = Pb-Free Package

(Note: Microdot may be in either location)

ORDERING INFORMATION

See detailed ordering and shipping information in the package dimensions section on page 4 of this data sheet.

UMC2NT1G, NSVUMC2NT1G, UMC3NT1G, NSVUMC3NT1G, UMC5NT1G, NSVUMC5NT2G

MAXIMUM RATINGS ($T_A = 25^\circ\text{C}$ unless otherwise noted, common for Q_1 and Q_2 , – minus sign for Q_1 (PNP) omitted)

| Rating | Symbol | Value | Unit |
|---|-----------------|-------------|--------------------|
| THERMAL CHARACTERISTICS | | | |
| Thermal Resistance – Junction-to-Ambient (surface mounted) | $R_{\theta JA}$ | 833 | $^\circ\text{C/W}$ |
| Operating and Storage Temperature Range | T_J, T_{stg} | -65 to +150 | $^\circ\text{C}$ |
| Total Package Dissipation @ $T_A = 25^\circ\text{C}$ (Note 1) | P_D | 150 | mW |

1. Device mounted on a FR-4 glass epoxy printed circuit board using the minimum recommended footprint.

ELECTRICAL CHARACTERISTICS ($T_A = 25^\circ\text{C}$ unless otherwise noted)

| Characteristic | Symbol | Min | Typ | Max | Unit |
|----------------|--------|-----|-----|-----|------|
|----------------|--------|-----|-----|-----|------|

Q1 TRANSISTOR: PNP

OFF CHARACTERISTICS

| | | | | | |
|---|-----------|---|---|-------------------|------|
| Collector-Base Cutoff Current ($V_{CB} = 50\text{ V}, I_E = 0$) | I_{CBO} | – | – | 100 | nAdc |
| Collector-Emitter Cutoff Current ($V_{CE} = 50\text{ V}, I_B = 0$) | I_{CEO} | – | – | 500 | nAdc |
| Emitter-Base Cutoff Current ($V_{EB} = 6.0, I_C = 0\text{ mA}$) UMC2NT1G, NSVUMC2NT1G UMC3NT1G, NSVUMC3NT1G UMC5NT1G/T2G, NSVUMC5NT2G | I_{EBO} | – | – | 0.2 0.5 1.0 | mAdc |

ON CHARACTERISTICS

| | | | | | |
|---|---------------|--------------------|--------------------|--------------------|------------|
| Collector-Base Breakdown Voltage ($I_C = 10\ \mu\text{A}, I_E = 0$) | $V_{(BR)CBO}$ | 50 | – | – | Vdc |
| Collector-Emitter Breakdown Voltage ($I_C = 2.0\text{ mA}, I_B = 0$) | $V_{(BR)CEO}$ | 50 | – | – | Vdc |
| DC Current Gain ($V_{CE} = 10\text{ V}, I_C = 5.0\text{ mA}$) UMC2NT1G, NSVUMC2NT1G UMC3NT1G, NSVUMC3NT1G UMC5NT1G/T2G, NSVUMC5NT2G | h_{FE} | 60 35 20 | 100 60 35 | – – – | |
| Collector-Emitter Saturation Voltage ($I_C = 10\text{ mA}, I_B = 0.3\text{ mA}$) | $V_{CE(SAT)}$ | – | – | 0.25 | Vdc |
| Output Voltage (on) ($V_{CC} = 5.0\text{ V}, V_B = 2.5\text{ V}, R_L = 1.0\text{ k}\Omega$) | V_{OL} | – | – | 0.2 | Vdc |
| Output Voltage (off) ($V_{CC} = 5.0\text{ V}, V_B = 0.5\text{ V}, R_L = 1.0\text{ k}\Omega$) | V_{OH} | 4.9 | – | – | Vdc |
| Input Resistor UMC2NT1G UMC3NT1G UMC5NT1G/T2G | R1 | 15.4 7.0 3.3 | 22 10 4.7 | 28.6 13 6.1 | k Ω |
| Resistor Ratio UMC2NT1G UMC3NT1G UMC5NT1G/T2G | R1/R2 | 0.8 0.8 0.38 | 1.0 1.0 0.47 | 1.2 1.2 0.56 | |

**UMC2NT1G, NSVUMC2NT1G, UMC3NT1G, NSVUMC3NT1G, UMC5NT1G,
NSVUMC5NT2G**

ELECTRICAL CHARACTERISTICS ($T_A = 25^\circ\text{C}$ unless otherwise noted)

| Characteristic | Symbol | Min | Typ | Max | Unit |
|----------------|--------|-----|-----|-----|------|
|----------------|--------|-----|-----|-----|------|

**Q2 TRANSISTOR: NPN
OFF CHARACTERISTICS**

| | | | | | |
|--|-----------|---|---|-----|------|
| Collector-Base Cutoff Current ($V_{CB} = 50\text{ V}$, $I_E = 0$) | I_{CBO} | - | - | 100 | nAdc |
| Collector-Emitter Cutoff Current ($V_{CE} = 50\text{ V}$, $I_B = 0$) | I_{CEO} | - | - | 500 | nAdc |
| Emitter-Base Cutoff Current ($V_{EB} = 6.0$, $I_C = 0\text{ mA}$) | I_{EBO} | | | | mAdc |
| UMC2NT1G | | - | - | 0.2 | |
| UMC3NT1G | | - | - | 0.5 | |
| UMC5NT1G/T2G | | - | - | 0.1 | |

ON CHARACTERISTICS

| | | | | | |
|---|---------------|------|-----|------|------------------|
| Collector-Base Breakdown Voltage ($I_C = 10\text{ }\mu\text{A}$, $I_E = 0$) | $V_{(BR)CBO}$ | 50 | - | - | Vdc |
| Collector-Emitter Breakdown Voltage ($I_C = 2.0\text{ mA}$, $I_B = 0$) | $V_{(BR)CEO}$ | 50 | - | - | Vdc |
| DC Current Gain ($V_{CE} = 10\text{ V}$, $I_C = 5.0\text{ mA}$) | h_{FE} | | | | |
| UMC2NT1G | | 60 | 100 | - | |
| UMC3NT1G | | 35 | 60 | - | |
| UMC5NT1G/T2G | | 80 | 140 | - | |
| Collector-Emitter Saturation Voltage ($I_C = 10\text{ mA}$, $I_B = 0.3\text{ mA}$) | $V_{CE(SAT)}$ | - | - | 0.25 | Vdc |
| Output Voltage (on) ($V_{CC} = 5.0\text{ V}$, $V_B = 2.5\text{ V}$, $R_L = 1.0\text{ k}\Omega$) | V_{OL} | - | - | 0.2 | Vdc |
| Output Voltage (off) ($V_{CC} = 5.0\text{ V}$, $V_B = 0.5\text{ V}$, $R_L = 1.0\text{ k}\Omega$) | V_{OH} | 4.9 | - | - | Vdc |
| Input Resistor | R1 | | | | $\text{k}\Omega$ |
| UMC2NT1G | | 15.4 | 22 | 28.6 | |
| UMC3NT1G | | 7.0 | 10 | 13 | |
| UMC5NT1G/T2G | | 33 | 47 | 61 | |
| Resistor Ratio | R1/R2 | | | | |
| UMC2NT1G | | 0.8 | 1.0 | 1.2 | |
| UMC3NT1G | | 0.8 | 1.0 | 1.2 | |
| UMC5NT1G/T2G | | 0.8 | 1.0 | 1.2 | |

UMC2NT1G, NSVUMC2NT1G, UMC3NT1G, NSVUMC3NT1G, UMC5NT1G, NSVUMC5NT2G

ORDERING INFORMATION

| Device | Package | Shipping [†] |
|-------------|-----------------------------|-----------------------|
| UMC2NT1G | SC-88A/SOT-353 (Pb-Free) | 3,000 / Tape & Reel |
| NSVUMC2NT1G | SC-88A/SOT-353 (Pb-Free) | 3,000 / Tape & Reel |
| UMC3NT1G | SC-88A/SOT-353 (Pb-Free) | 3,000 / Tape & Reel |
| NSVUMC3NT1G | SC-88A/SOT-353 (Pb-Free) | 3,000 / Tape & Reel |
| UMC3NT2G | SC-88A/SOT-353 (Pb-Free) | 3,000 / Tape & Reel |
| UMC5NT1G | SC-88A/SOT-353 (Pb-Free) | 3,000 / Tape & Reel |
| UMC5NT2G | SC-88A/SOT-353 (Pb-Free) | 3,000 / Tape & Reel |
| NSVUMC5NT2G | SC-88A/SOT-353 (Pb-Free) | 3,000 / Tape & Reel |

[†]For information on tape and reel specifications, including part orientation and tape sizes, please refer to our Tape and Reel Packaging Specifications Brochure, BRD8011/D.

DEVICE MARKING AND RESISTOR VALUES

| Device | Marking | Transistor 1 - PNP | | Transistor 2 - NPN | |
|-----------------------|---------|--------------------|--------|--------------------|--------|
| | | R1 (K) | R2 (K) | R1 (K) | R2 (K) |
| UMC2NT1G, NSVUMC2NT1G | U2 | 22 | 22 | 22 | 22 |
| UMC3NT1G, NSVUMC3NT1G | U3 | 10 | 10 | 10 | 10 |
| UMC3NT2G | U3 | 10 | 10 | 10 | 10 |
| UMC5NT1G | U5 | 4.7 | 10 | 47 | 47 |
| UMC5NT2G, NSVUMC5NT2G | U5 | 4.7 | 10 | 47 | 47 |

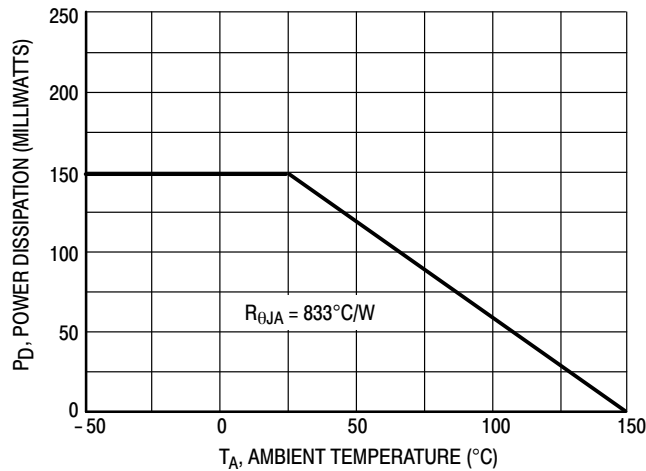

Figure 1. Derating Curve

**UMC2NT1G, NSVUMC2NT1G, UMC3NT1G, NSVUMC3NT1G, UMC5NT1G,
NSVUMC5NT2G**

TYPICAL ELECTRICAL CHARACTERISTICS — UMC2NT1G, NSVUMC2NT1G PNP TRANSISTOR

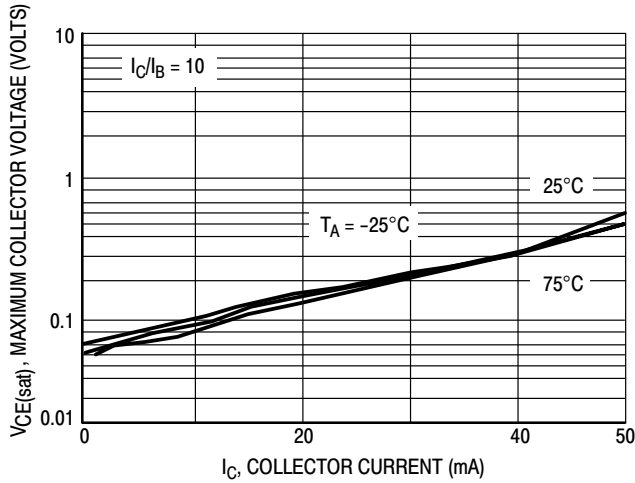

Figure 2. $V_{CE(sat)}$ versus I_C



Figure 3. DC Current Gain

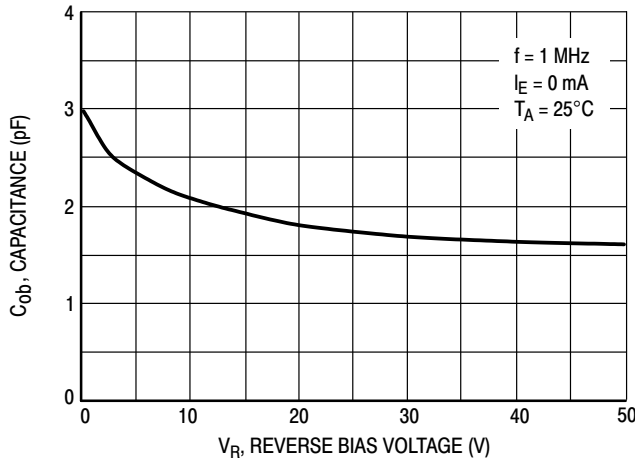

Figure 4. Output Capacitance



Figure 5. Output Current versus Input Voltage

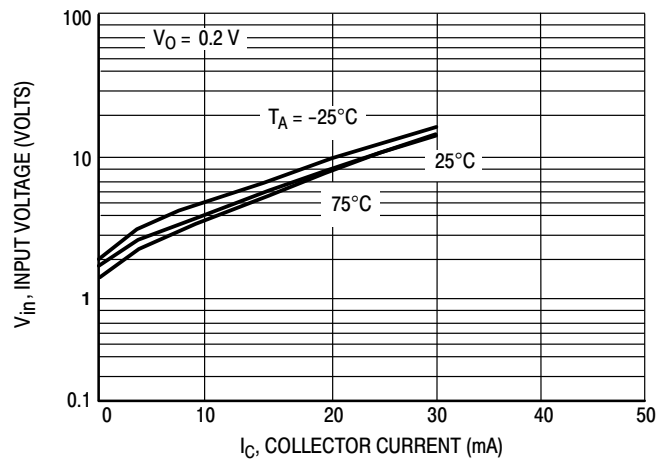

Figure 6. Input Voltage versus Output Current

UMC2NT1G, NSVUMC2NT1G, UMC3NT1G, NSVUMC3NT1G, UMC5NT1G, NSVUMC5NT2G

TYPICAL ELECTRICAL CHARACTERISTICS — UMC2NT1G, NSVUMC2NT1G NPN TRANSISTOR



Figure 7. $V_{CE(sat)}$ versus I_C

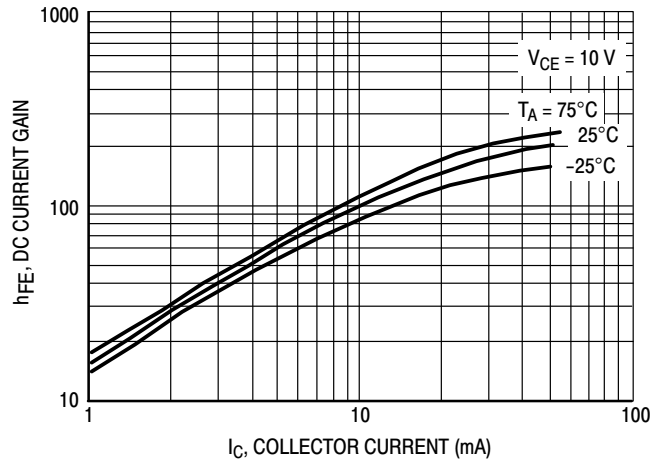

Figure 8. DC Current Gain



Figure 9. Output Capacitance

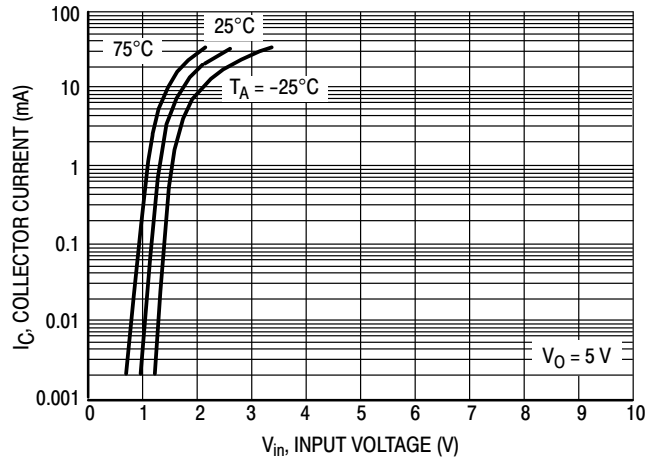

Figure 10. Output Current versus Input Voltage

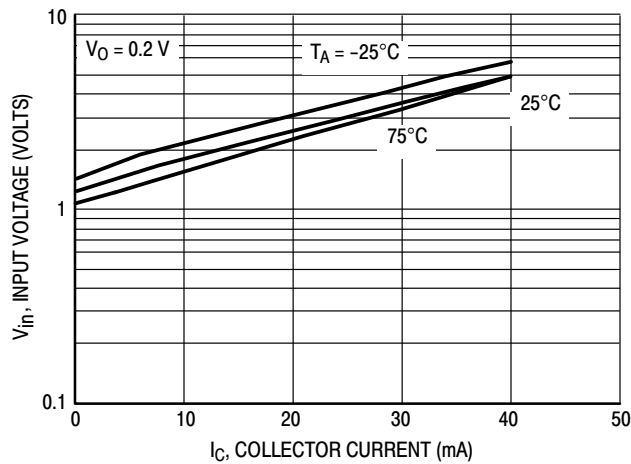

Figure 11. Input Voltage versus Output Current

UMC2NT1G, NSVUMC2NT1G, UMC3NT1G, NSVUMC3NT1G, UMC5NT1G, NSVUMC5NT2G

TYPICAL ELECTRICAL CHARACTERISTICS — UMC3NT1G PNP TRANSISTOR

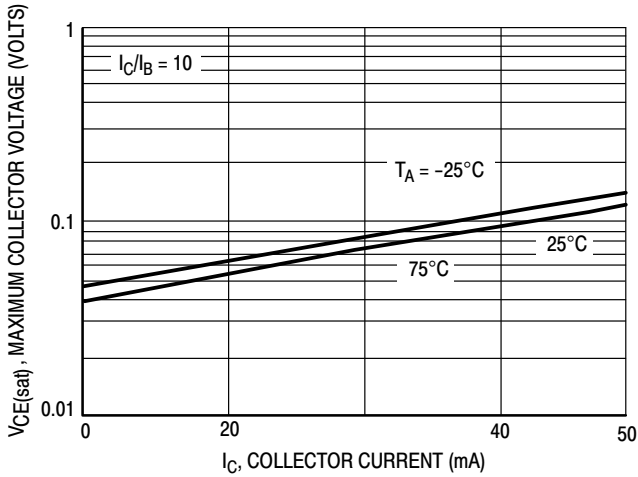

Figure 12. $V_{CE(sat)}$ versus I_C

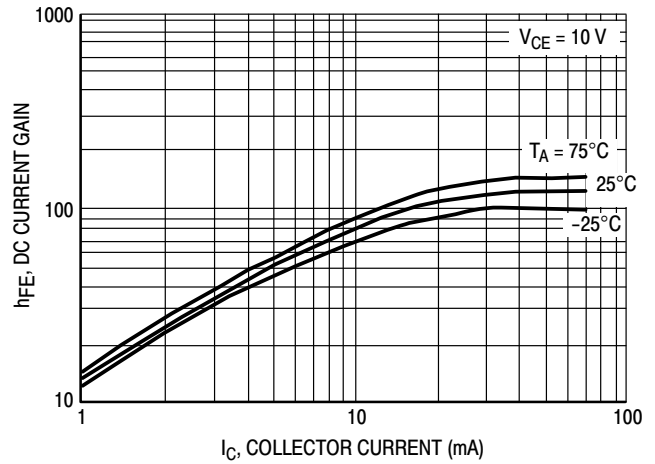

Figure 13. DC Current Gain

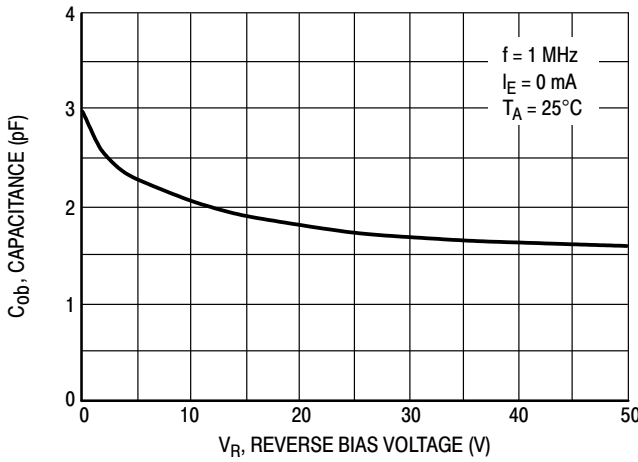

Figure 14. Output Capacitance

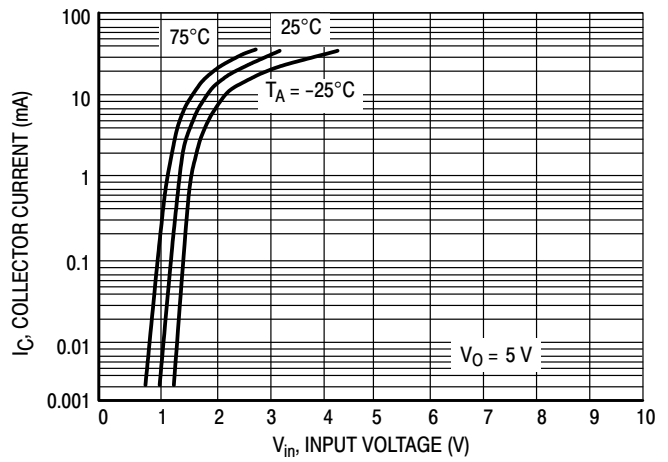

Figure 15. Output Current versus Input Voltage

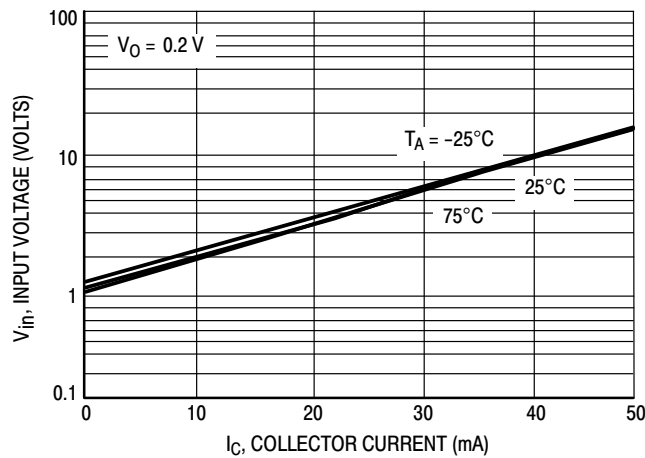

Figure 16. Input Voltage versus Output Current

UMC2NT1G, NSVUMC2NT1G, UMC3NT1G, NSVUMC3NT1G, UMC5NT1G, NSVUMC5NT2G

TYPICAL ELECTRICAL CHARACTERISTICS — UMC3NT1G NPN TRANSISTOR

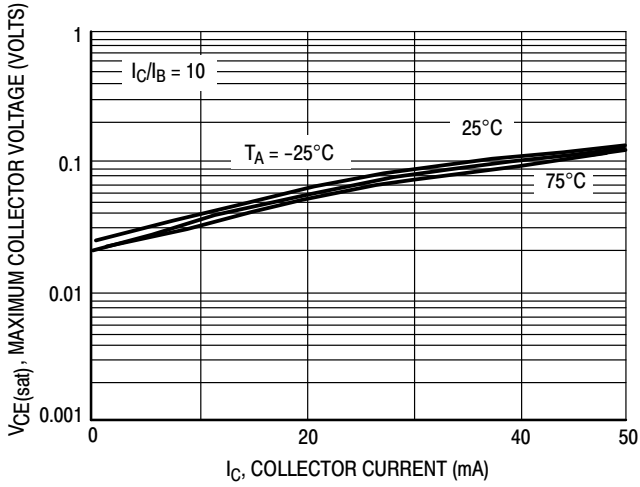

Figure 17. $V_{CE(sat)}$ versus I_C



Figure 18. DC Current Gain

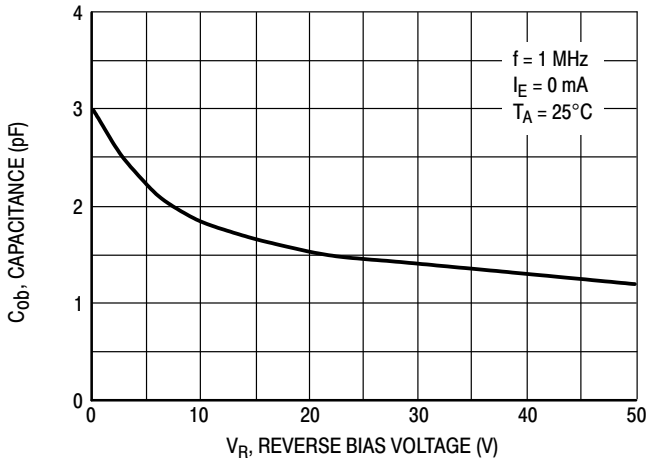

Figure 19. Output Capacitance

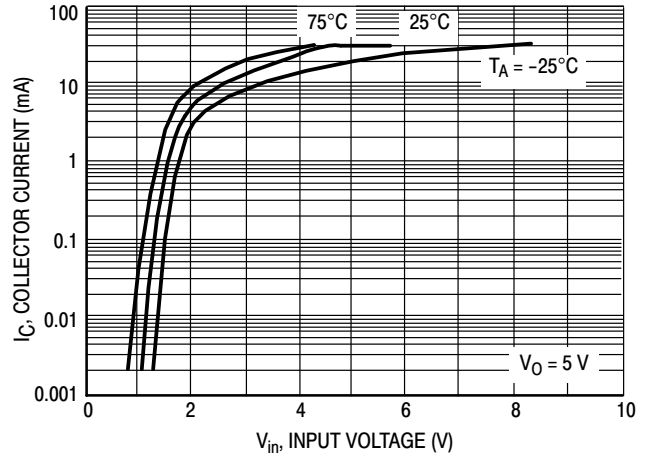

Figure 20. Output Current versus Input Voltage



Figure 21. Input Voltage versus Output Current

UMC2NT1G, NSVUMC2NT1G, UMC3NT1G, NSVUMC3NT1G, UMC5NT1G, NSVUMC5NT2G

TYPICAL ELECTRICAL CHARACTERISTICS — UMC5NT1G PNP TRANSISTOR



Figure 22. $V_{CE(sat)}$ versus I_C

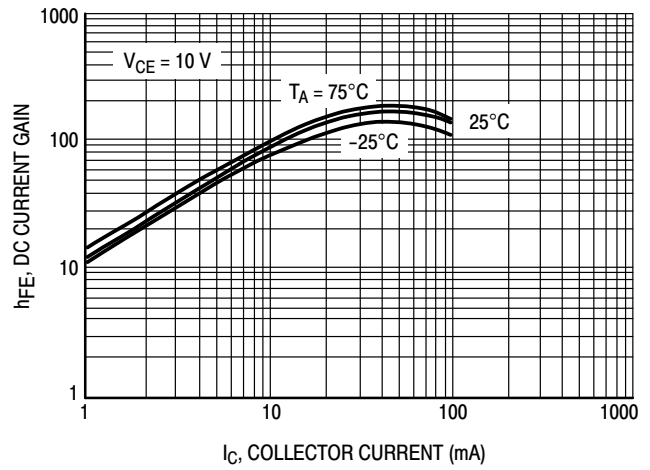

Figure 23. DC Current Gain



Figure 24. Output Capacitance

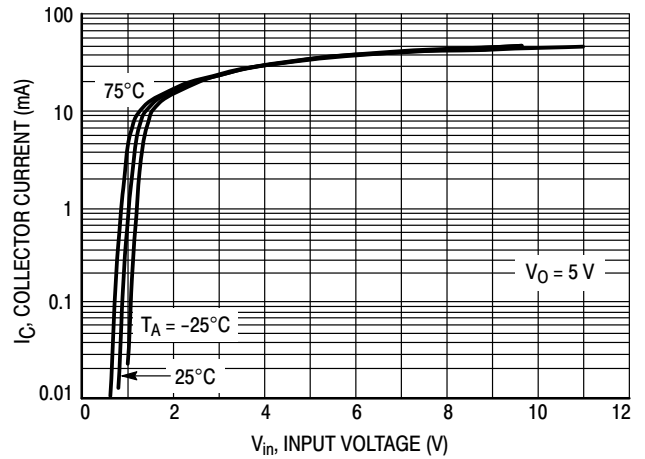

Figure 25. Output Current versus Input Voltage

UMC2NT1G, NSVUMC2NT1G, UMC3NT1G, NSVUMC3NT1G, UMC5NT1G, NSVUMC5NT2G

TYPICAL ELECTRICAL CHARACTERISTICS — UMC5NT1G NPN TRANSISTOR

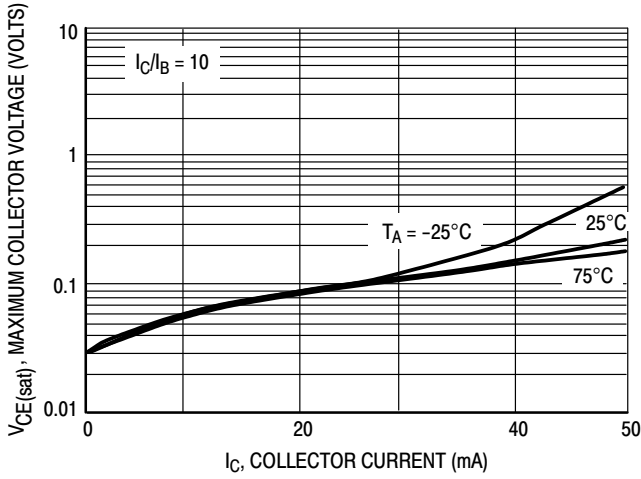

Figure 26. $V_{CE(sat)}$ versus I_C

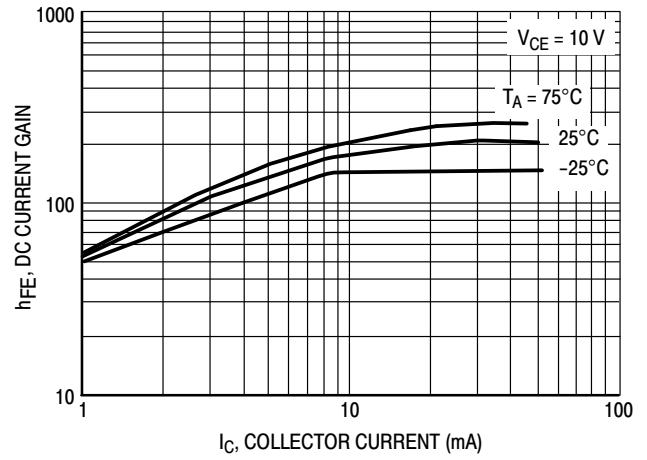

Figure 27. DC Current Gain



Figure 28. Output Capacitance



Figure 29. Output Current versus Input Voltage

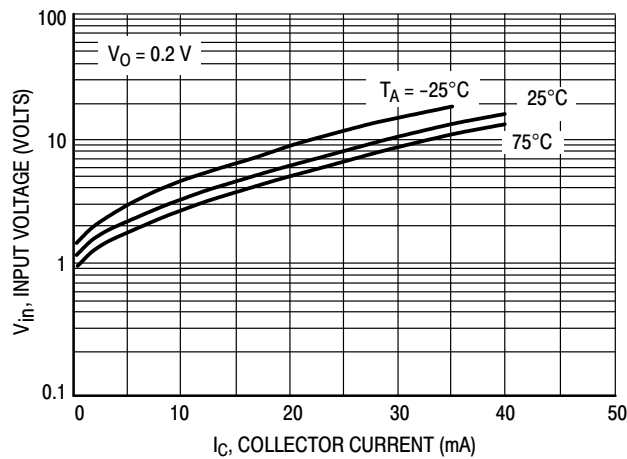
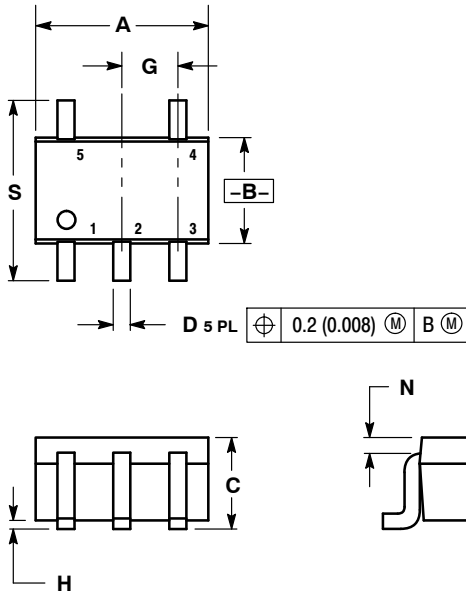

Figure 30. Input Voltage versus Output Current

UMC2NT1G, NSVUMC2NT1G, UMC3NT1G, NSVUMC3NT1G, UMC5NT1G, NSVUMC5NT2G

PACKAGE DIMENSIONS

SC-88A (SC-70-5/SOT-353)
CASE 419A-02
ISSUE K



NOTES:

1. DIMENSIONING AND TOLERANCING PER ANSI Y14.5M, 1982.
2. CONTROLLING DIMENSION: INCH.
3. 419A-01 OBSOLETE. NEW STANDARD 419A-02.
4. DIMENSIONS A AND B DO NOT INCLUDE MOLD FLASH, PROTRUSIONS, OR GATE BURRS.

| DIM | INCHES | | MILLIMETERS | |
|-----|-----------|-------|-------------|------|
| | MIN | MAX | MIN | MAX |
| A | 0.071 | 0.087 | 1.80 | 2.20 |
| B | 0.045 | 0.053 | 1.15 | 1.35 |
| C | 0.031 | 0.043 | 0.80 | 1.10 |
| D | 0.004 | 0.012 | 0.10 | 0.30 |
| G | 0.026 BSC | | 0.65 BSC | |
| H | --- | 0.004 | --- | 0.10 |
| J | 0.004 | 0.010 | 0.10 | 0.25 |
| K | 0.004 | 0.012 | 0.10 | 0.30 |
| N | 0.008 REF | | 0.20 REF | |
| S | 0.079 | 0.087 | 2.00 | 2.20 |

STYLE 6:

- PIN 1. EMITTER 2
- BASE 2
- EMITTER 1
- COLLECTOR
- COLLECTOR 2/BASE 1

SOLDERING FOOTPRINT*



*For additional information on our Pb-Free strategy and soldering details, please download the ON Semiconductor Soldering and Mounting Techniques Reference Manual, SOLDERRM/D.

ON Semiconductor and are registered trademarks of Semiconductor Components Industries, LLC (SCILLC). SCILLC reserves the right to make changes without further notice to any products herein. SCILLC makes no warranty, representation or guarantee regarding the suitability of its products for any particular purpose, nor does SCILLC assume any liability arising out of the application or use of any product or circuit, and specifically disclaims any and all liability, including without limitation special, consequential or incidental damages. "Typical" parameters which may be provided in SCILLC data sheets and/or specifications can and do vary in different applications and actual performance may vary over time. All operating parameters, including "Typicals" must be validated for each customer application by customer's technical experts. SCILLC does not convey any license under its patent rights nor the rights of others. SCILLC products are not designed, intended, or authorized for use as components in systems intended for surgical implant into the body, or other applications intended to support or sustain life, or for any other application in which the failure of the SCILLC product could create a situation where personal injury or death may occur. Should Buyer purchase or use SCILLC products for any such unintended or unauthorized application, Buyer shall indemnify and hold SCILLC and its officers, employees, subsidiaries, affiliates, and distributors harmless against all claims, costs, damages, and expenses, and reasonable attorney fees arising out of, directly or indirectly, any claim of personal injury or death associated with such unintended or unauthorized use, even if such claim alleges that SCILLC was negligent regarding the design or manufacture of the part. SCILLC is an Equal Opportunity/Affirmative Action Employer. This literature is subject to all applicable copyright laws and is not for resale in any manner.

PUBLICATION ORDERING INFORMATION

LITERATURE FULFILLMENT:
Literature Distribution Center for ON Semiconductor
P.O. Box 5163, Denver, Colorado 80217 USA
Phone: 303-675-2175 or 800-344-3860 Toll Free USA/Canada
Fax: 303-675-2176 or 800-344-3867 Toll Free USA/Canada
Email: orderlit@onsemi.com

N. American Technical Support: 800-282-9855 Toll Free
USA/Canada
Europe, Middle East and Africa Technical Support:
Phone: 421 33 790 2910
Japan Customer Focus Center
Phone: 81-3-5817-1050

ON Semiconductor Website: www.onsemi.com
Order Literature: <http://www.onsemi.com/orderlit>
For additional information, please contact your local Sales Representative