



- Modular version for modular-slot switchboards, also suitable for rear mounting plate fixing
- Plug-in or flush-mount version
- Version programmable with NFC
- Vast range of functions and time scales
- Reliable time and repeat accuracy.

	<b>SEC. - PAGE</b>
<b>Modular version</b>	
On delay. Multiscale. Multivoltage .....	17 - 2
Multifunction. Multiscale. Multivoltage. 1 relay output .....	17 - 2
Multifunction. Multiscale. Multivoltage. 1 relay output, with NFC and APP .....	17 - 2
Multifunction. Multiscale. Multivoltage. 2 relay outputs .....	17 - 3
Recycle, independent timings. Multiscale. Multivoltage .....	17 - 3
Off delay. Multiscale. Multivoltage .....	17 - 3
For starting. Multiscale. Multivoltage .....	17 - 4
For staircase .....	17 - 4
<b>Plug-in and flush-mount version, 48x48mm/1.9x1.9"</b>	
On delay. Multiscale. Multivoltage .....	17 - 5
On delay. Multiscale. Single voltage .....	17 - 5
Multifunction. Multiscale. Multivoltage .....	17 - 5
Accessories .....	17 - 5
<b>Dimensions .....</b>	<b>17 - 6</b>
<b>Wiring diagrams .....</b>	<b>17 - 6</b>
<b>Technical characteristics .....</b>	<b>17 - 10</b>



Page 17-2

#### MODULAR TIME RELAYS

- Suitable for modular-slot switchboards
- Selectable time ranges and functions with potentiometers on front or via NFC and APP
- LED indication
- Mounting on 35mm DIN rail
- Screw terminals.



Page 17-5

#### PLUG-IN AND FLUSH-MOUNT TIME RELAYS, 48X48MM

- Flush and internal panel mounting
- Time ranges: 0.05s...10h
- LED indication
- 8 and 11-pin sockets for panel mounting.

**On delay time relay.  
Multiscale. Multivoltage**



TM P

Order code	Time of scale range	Rated auxiliary supply voltage [V]	Qty per pkg n°	Wt [kg]
TM P	0.1...1s 1...10s 6...60s 1...10min 6min...1h 1...10h 0.1...1 day 1...10 days ON only OFF only	24...48VDC 24...240VAC	1	0.048
TM P A440	0.1...1s 1...10s 6...60s 1...10min	380...440VAC	1	0.090

**General characteristics**

- Electronic time relay, multiscale, multivoltage.
- On delay, delay on make, with start at relay energising for TM P
- Electronic time relay, multiscale with 2 normally open (N/O-SPST) contacts with common pole for TM P A 440.
- 1 relay output with 1 changeover contact (SPDT)
- Delay time adjustable on front by rotary switch: 10...100%
- Green LED indicator for power on
- Red LED indicator for relay state; flashing for delay and steady when relay energised
- Modular DIN 43880 housing, 1 module
- IEC degree of protection: IP40 on front (only when mounted in housing or electric board with IP40); IP20 on terminals.

**Certifications and compliance**

Certifications obtained: EAC; UL Listed, for USA and Canada (cULus - File E93601).  
Compliant with standards: IEC/EN 61812-1, UL508, CSA C22.2 n° 14.

**Multifunction time relay.  
Multiscale. Multivoltage.  
1 relay output**



TM M1

Order code	Time of scale range	Rated auxiliary supply voltage [V]	Qty per pkg n°	Wt [kg]
TM M1	0.1...1s 1...10s 6...60s 1...10min 6min...1h 1...10h 0.1...1 day 1...10 days ON only OFF only	12...240V AC/DC	1	0.086

**General characteristics**

- Electronic time relay, multifunction, multiscale, multivoltage, with 1 relay output SPDT
- Enabling input
- Selectable functions: (a) On delay. (b) Pulse on relay energising with start when energised. (c) Symmetrical flasher starting with OFF. (d) Symmetrical flasher starting with ON. (e) Off delay; relay energising at external contact closing with start on break. (f) Pulse on relay energising with start on external contact closing. (g) Pulse on relay energising with start on external contact opening. (h) On-off delay. Delay on make, with start at external contact closing, and delay at break, with start at external contact opening. (i) Internal ON/OFF trigger with relay contact closing or operating at each closing of an external contact. (j) Pulse generator.
- Delay time adjustable on front by rotary switch: 10...100%
- Green LED indicator for power on
- Red LED indicator for relay state; flashing for delay and steady when relay energised
- Modular DIN 43880 housing, 1 module suitable for fixing on 35mm DIN rail (IEC/EN 60715)
- IEC degree of protection: IP40 on front (only when mounted in housing or electric board with IP40); IP20 on terminals.

**Certifications and compliance**

Certifications obtained: EAC; UL Listed, for USA and Canada (cULus - File E93601).  
Compliant with standards: IEC/EN 61812-1, UL508, CSA C22.2 n° 14.

**Multifunction time relay.  
Multiscale. Multivoltage.  
1 relay output.  
Programmable  
with NFC and APP**



TM M1 NFC

**new**



Order code	Time of scale range	Rated auxiliary supply voltage [V]	Qty per pkg n°	Wt [kg]
TM M1 NFC	0.1s... 999days ON only OFF only	12...240V AC/DC	1	0.086

**General characteristics**

- Electronic time relay, multifunction, multiscale, multivoltage, with 1 relay output with changeover contact (SPDT), with NFC technology and APP **NFC** Lovato
- Command input for the enabling of the function or to pause the timing
- 40 selectable functions. For details consult the technical manual on the website [www.LovatoElectric.com](http://www.LovatoElectric.com)
- NFC connectivity for the programming of the parameters with the APP **NFC**
- Simple, fast and intuitive programming
- Very high accuracy and repeatability of the settings
- Internal counter which stops the function when the relay output reaches a programmable number of closures
- Possibility to save the program on smartphone or tablet to be copied on others TM M1 NFC, even with device powered off
- Possibility to protect the settings with a password
- QR code for the direct connection to the LOVATO Electric website for the download of the technical manual
- Green LED indicator for power on
- Red LED indicator for relay state; flashing for delay and steady when relay energised
- Modular DIN 43880 housing (1 module), suitable for fixing on 35mm DIN rail (IEC/EN 60715)
- IEC degree of protection: IP40 on front (only when mounted in housing or electric board with IP40), IP20 on terminals.

**Certifications and compliance**

Certifications (pending): cULus, EAC.  
Compliant with standards: IEC/EN 61812-1, UL508, CSA C22.2 n°14.

**Multifunction time relay.  
Multiscale. Multivoltage.  
2 relay outputs**



TM M2

Order code	Time of scale range	Rated auxiliary supply voltage	Qty per pkg	Wt
		[V]	n°	[kg]
<b>TM M2</b>	0.1...1s 1...10s 6...60s 1...10min 6min...1h 1...10h 0.1...1 day 1...10 days ON only OFF only	12...240V AC/DC	1	0.094

**General characteristics**

- Electronic time relay, multifunction, multiscale, multivoltage
- Enabling input
- 2 relay outputs, one with 1 delayed changeover (C/O-SPDT) contact and the other with 1 normally open (N/O-SPST) contact, programmable as instantaneous or delayed
- Selectable functions: (a) On delay; delay on make with start at relay energising. (b) Pulse on relay energising with start when energised. (c) Flasher starting with OFF interval. Equal timing recycle. (d) Flasher starting with ON interval. Equal timing recycle. (e) Off delay; relay energising at external contact closing with start on break. (f) Pulse on relay energising with start on external contact closing. (g) Pulse on relay energising with start on external contact opening. (h) On-off delay. Delay on make, with start at external contact closing, and delay at break, with start at external contact opening. (i) Internal ON/OFF trigger with relay contact closing or operating at each closing of an external contact. (j) Pulse generator, unequal timing recycle; starting with OFF pulse time and 0.5s ON pulse.
- Delay time adjustable on front by rotary switch: 10...100%
- Green LED indicator for power on
- Red LED indicator for relay state; flashing for delay and steady when relay energised
- Modular DIN 43880 housing, 1 module suitable for fixing on 35mm DIN rail (IEC/EN 60715)
- IEC degree of protection: IP40 on front (only when mounted in housing or electric board with IP40); IP20 on terminals.

**Certifications and compliance**

Certifications obtained: EAC; UL Listed, for USA and Canada (cULus - File E93601) as Auxiliary Devices - Timers. Compliant with standards: IEC/EN 61812-1, UL508, CSA C22.2 n° 14.

**Recycle time relay,  
independent timings.  
Multiscale.  
Multivoltage**



TM PL

Order code	Time of scale range	Rated auxiliary supply voltage	Qty per pkg	Wt
		[V]	n°	[kg]
<b>TM PL</b>	0.1...1s 1...10s 6...60s 1...10min 6min...1h 1h...10h 0.1...1 day 1...10 days 3...30 days 10...100 days	12...240V AC/DC	1	0.082

**General characteristics**

- Programmable time relay asymmetrical recycle time, multiscale, multivoltage. Flasher with independent timing for ON and OFF intervals
- Enabling input of ON or OFF interval
- 1 relay output with 1 changeover contact (SPDT)
- Delay time for OFF (pause) interval, adjustable on front by rotary switch: 10...100%
- Delay time for ON (work) interval, adjustable on front by rotary switch: 10...100%
- Green LED indicator for power on
- Red LED indicator for relay state; flashing for delay
- Modular DIN 43880 housing, 1 module; suitable for fixing on 35mm DIN rail (IEC/EN 60715)
- IEC degree of protection: IP40 on front (only when mounted in housing or electric board with IP40); IP20 on terminals.

**Certifications and compliance**

Certifications obtained: EAC; UL Listed, for USA and Canada (cULus - File E93601) as Auxiliary Devices - Timers. Compliant with standards: IEC/EN 61812-1, UL508, CSA C22.2 n° 14.

**Off delay time relay.  
Multiscale.  
Multivoltage**



TM D

Order code	Time of scale range	Rated auxiliary supply voltage	Qty per pkg	Wt
		[V]	n°	[kg]
<b>TM D</b>	0.06...0.6s 0.6...6s 6...60s 18...180s	24...240V AC/DC	1	0.080

**General characteristics**

- Electronic time relay, multiscale, multivoltage. True off delay; delay on break with start at relay de-energising
- 1 relay output with 1 changeover contact (SPDT)
- Delay time adjustable on front by rotary switch: 10...100%
- Green LED indicator for power on
- Modular DIN 43880 housing, 1 module; suitable for fixing on 35mm DIN rail (IEC/EN 60715)
- IEC degree of protection: IP40 on front (only when mounted in housing or electric board with IP40); IP20 on terminals.

**Certifications and compliance**

Certifications obtained: EAC; UL Listed, for USA and Canada (cULus - File E93601) as Auxiliary Devices - Timers. Compliant with standards: IEC/EN 61812-1, UL508, CSA C22.2 n° 14.

**Time relay for starting.**  
**Multiscale.**  
**Multivoltage**



TM ST

Order code	Time of scale range	Rated auxiliary supply voltage [V]	Qty per pkg n°	Wt [kg]
TM ST	0.1...1s	24...48VDC	1	0.090
	1...10s	24...240VAC		
	6...60s			
	1...10min			
TM ST A440	0.1...1s	380...440VAC	1	0.090
	1...10s			
	6...60s			
	1...10min			

**General characteristics**

- Electronic time relay, multiscale, multivoltage for starting (star-delta, impedance, autotransformer, etc) of induction motors (squirrel cage), 2 separate timings
- 1 relay output with 2 normally open (N/O-SPST) contacts with common pole
- Delay time adjustable on front by rotary switch: 10-100% for star connection
- Starting and transition (20...300ms time scale - from star to delta), time adjustable on front by rotary switch
- Green LED indicator for power on
- Red LED indicator for relay state; flashing during delay and steady at delay lapsing
- Modular DIN 43880 housing, 1 module; suitable for fixing on 35mm DIN rail (IEC/EN 60715)
- IEC degree of protection: IP40 on front (only when mounted in housing or electric board with IP40); IP20 on terminals.

**Certifications and compliance**

Certifications obtained: EAC; UL Listed, for USA and Canada (cULus - File E93601) as Auxiliary Devices - Timers. Compliant with standards: IEC/EN 61812-1, UL508, CSA C22.2 n° 14.

**Time relay for staircase**



TM LS

Order code	Time of scale range	Rated auxiliary supply voltage [V]	Qty per pkg n°	Wt [kg]
TM LS	0.5...20min	220...240VAC	1	0.080

**General characteristics**

- Electronic time relay single scale and voltage for staircase illumination
- 1 relay output with 1 powered normally open (N/O-SPST) contact
- Delay time adjustable on front by rotary switch
- Suitable for 3 or 4-wire systems
- 1 slide switch for timed or constant lighting operation
- Function for one hour lighting and fast switch off
- Green LED indicator for power on
- Connection with up to 50 light-up switches maximum; ≤ 1mA each
- Modular DIN 43880 housing, 1 module suitable for fixing on 35mm DIN rail (IEC/EN 60715)
- IEC degree of protection: IP40 on front (only when mounted in housing or electric board with IP40); IP20 on terminals.

**Certifications and compliance**

Certifications obtained: EAC; UL Listed, for USA and Canada (cULus - File E93601) as Auxiliary Devices - Timers. Compliant with standards: IEC/EN 61812-1, UL508, CSA C22.2 n° 14.

# 17 Time relays

Plug-in and flush mount version 48x48mm/1.9x1.9"  
Accessories

## Time relay



31 L48TP...



31 L48TPB...



31 L48M...

## Accessories for 48x48mm time relay



HR7X S1



31 L48 P8



HR7X S2



31 L48 P11

Order code	Time scale range	Rated auxiliary supply voltage	Qty per pkg	Wt
		[V]	n°	[kg]
Time relay on delay. Multiscale and multivoltage.				
31 L48TP S 240	0.3...780s	24VAC/DC	1	0.124
31 L48TP M 240	18s...780min	110VAC 220...240VAC	1	0.124
Time relay on delay. Multiscale and single voltage.				
31 L48TPB M24	0.05s...10min	24VAC/DC	1	0.124
31 L48TPB M240		220...240VAC	1	0.124
Time relay, multifunction, multivoltage and multiscale.				
31 L48M M 240	0.05s...10min	24...240V	1	0.135
31 L48M H 240	0.05min...10h	AC/DC	1	0.135

Order code	Description	Qty per pkg	Wt
		n°	[kg]
<b>new</b> HR7X S1	8-pin socket for screw fixing or on 35mm DIN rail (IEC/EN 60715) of time relay type L48T...	10	0.061
31 L48 P8	8-pin socket for the door-mounting of time relay type L48T... with accessory 31 L48AP	10	0.040
<b>new</b> HR7X S2	11-pin socket for screw fixing or on 35mm DIN rail (IEC/EN 60715) of time relay type L48M....	10	0.064
31 L48 P11	11-pin socket for the door-mounting of time relay type L48M... with accessory 31 L48AP	10	0.048
31 L48AP	Flush mount bracket	10	0.012

NOTE: Max. conductor section for sockets: 2x2.5mm<sup>2</sup>/2x14AWG.  
Tightening torque: 0.8Nm/7.1lb.in.

### General characteristics

- TIME RELAY L48TP**
- Electronic time relay, multiscale, multivoltage.
  - On delay, delay on make with start at relay energising
  - 1 relay output with 1 changeover contact (SPDT)
  - Delay time adjustable on front by rotary knob
  - Time range selected by dip switches:
    - L48TP S: 0.3...3s; 1.2...12s; 10...100s; 7.8...780s
    - L48TP M: 18s...3min; 72s...12min; 10...100min; 78...780min
  - LED indicators for power on and relay state
  - Plug-in housing with 8-pin socket, HR7X S1 or 31 L48 P8 with accessory 31 L48AP
  - Flush mount bracket 31 L48AP available
  - IEC protection degree: IP40 on front and IP20 at terminals.

### Time range setting

	A B	A B	A B	A B
	1 0	1 0	1 0	1 0
L48TP S	0.3...3s	1.2...12s	10...100s	7.8...780s
L48TP M	18s...3min	72s...12min	10...100min	78...780min

### TIME RELAY L48TPB

- Electronic time relay, multiscale, single voltage, multifunction
- 2 relay outputs, each with 1 changeover contact (SPDT), configurable either delay on make or instantaneous
- Delay time adjustable on front by rotary knob
- Time range selected by dip switches:
  - 0.05...1s; 0.1...10s; 0.6s...1min; 6s...10min
- LED indicators for power on and relay state
- Plug-in housing with 8-pin socket, HR7X S1 or 31 L48 P8 with accessory 31 L48AP
- Flush mount bracket 31 L48AP available
- IEC protection degree: IP40 on front and IP20 at terminals.

### Time range setting

	A B	A B	A B	A B
	1 0	1 0	1 0	1 0
L48TPB	0.05...1s	0.1...10s	0.6s...1min	6s...10min

### TIME RELAY L48M

- Electronic time relay, multiscale, multivoltage, multifunction
- Selectable functions: On delay, delay on make with start at relay energising. On delay, delay on break with start at relay de-energising. Flasher, starting with OFF interval. Flasher, starting with ON interval. Time relay resetting is possible on closing of external contact (R) connected to terminals 7-6. Possible time relay stopping storing elapsed time on closing of external contact (M) connected to terminals 7-5 and then restarting time on its opening. See diagrams on page 17-9
- 2 relay outputs, each with 1 changeover contact; both delayed (SPDT)
- Delay time adjustable on front by rotary knob
- Time range selected by dip switches:
  - L48M M: 0.05...1s; 0.1...10s; 0.6s...1min; 6s...10min
  - L48M H: 0.05...1min; 0.1...10min; 0.6min...1h; 1min...10h
- LED indicators for power on and relay state
- Plug-in housing with 11-pin socket, HR7X S2 or 31 L48 P11 with accessory 31 L48AP
- Flush mount bracket 31 L48AP available
- IEC protection degree: IP40 on front and IP20 at terminals.

### Time range setting

	A B	A B	A B	A B
	1 0	1 0	1 0	1 0
L48M M	0.05...1s	0.1...10s	0.6s...1min	6s...10min
L48M H	0.05...1min	0.1...10min	0.6min...1h	1min...10h

### SOCKETS HR7X... AND L48...

- 8-pin and 11-pin version
- Screw fixing or on DIN rail for HR7X..., flush mount for L48... with accessory 31 L48AP
- Screw terminals
- Ratings: 10A - 250VAC.

### Certifications and compliance

Certifications obtained: cURus (for L48T..., L48M... and HR7X... type), EAC.  
Compliant with standards: IEC/EN 61810 (for HR7X... type), IEC/EN 61812-1, UL508, CSA C22.2 n° 14.

**TIME RELAYS**  
**TM...**

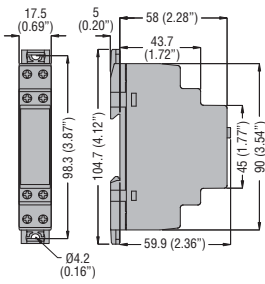

**L48...**

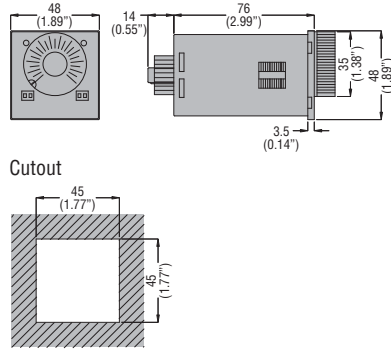

**ACCESSORIES - SOCKETS**  
**HR7XS1**

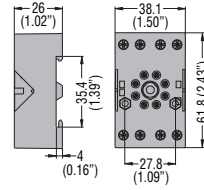

**HR7XS2**

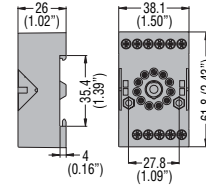

**L48 P8**

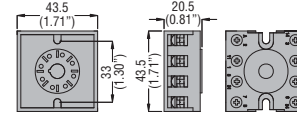

**L48 P11**

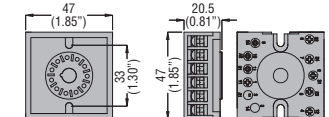

**Wiring diagrams**

**TM P**

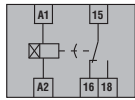

On delay. Delay on make, with start at relay energising

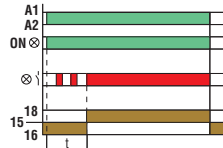

**TM P A440**

On delay. Delay on make, with start at relay energising

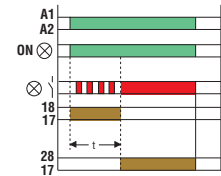
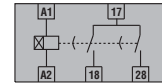

**TM M1**

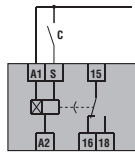

On delay. Delay on make, with start at relay energising

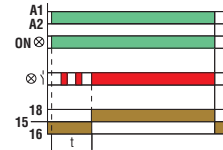

Pulse on relay energising with start at external contact closing

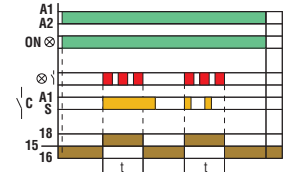

Pulse on relay energising with start on energising

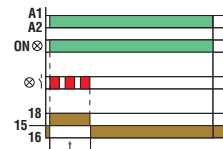

Pulse on relay energising with start at external contact opening

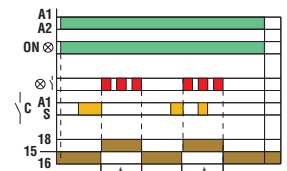

Flasher, starting with OFF (pause) interval. Equal timing recycle

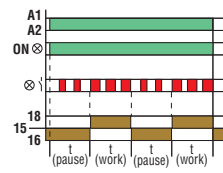

On-Off delay. Delay on make, with start at external contact closing, and delay at break, with start at external contact opening

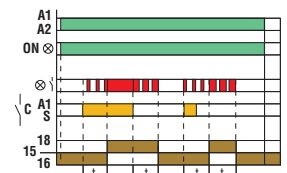

Flasher, starting with ON (work) interval. Equal timing recycle

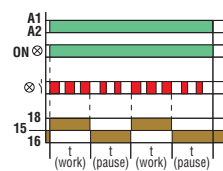

Internal ON/OFF trigger. Relay contact either closes or opens at each external contact closing

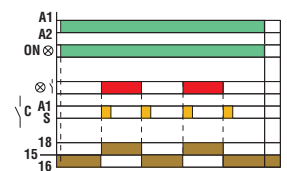

Off delay. Relay energising at external contact closing with start on break

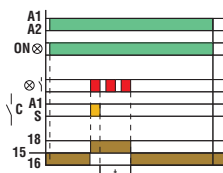

Pulse generator. Unequal timing recycle, starting with OFF pulse time and 0.5sec ON time

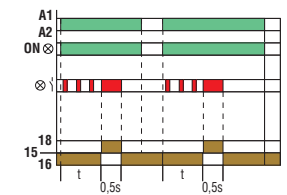

**TM M1 NFC**

For operational diagrams see instructions manual on the website [www.LovatoElectric.com](http://www.LovatoElectric.com).

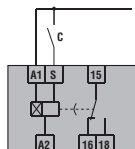

### TM M2

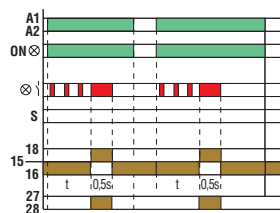
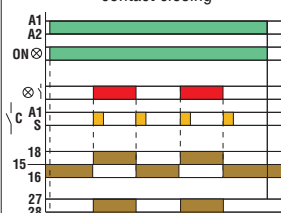
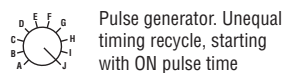
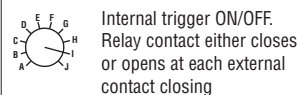
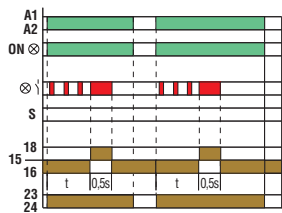
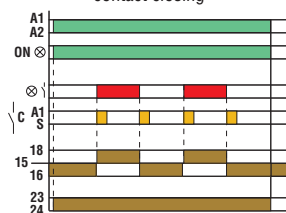
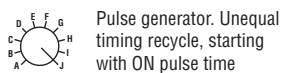
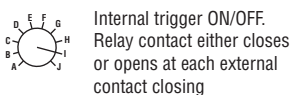
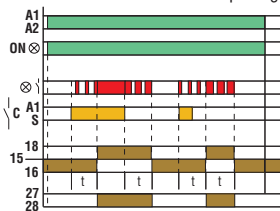
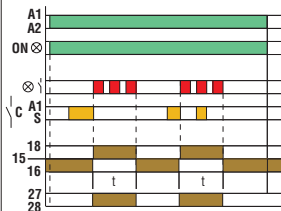
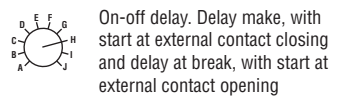
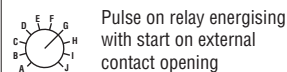
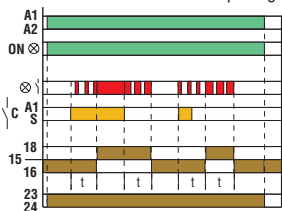
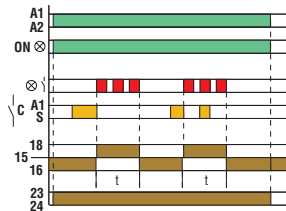
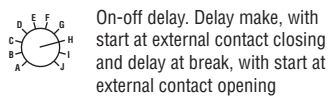
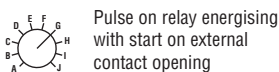
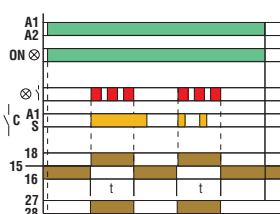
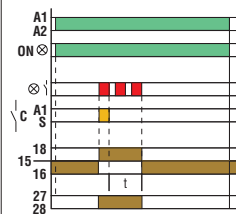
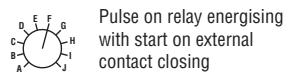
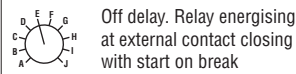
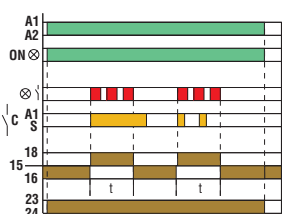
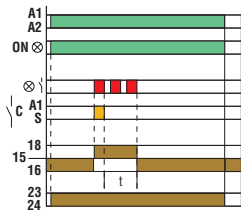
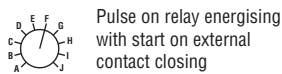
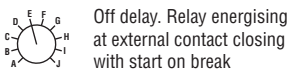
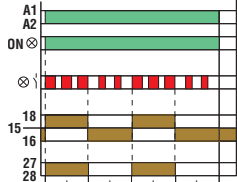
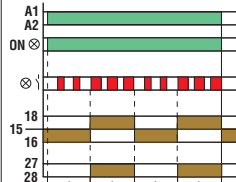
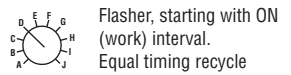
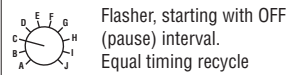
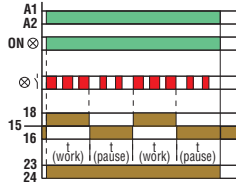
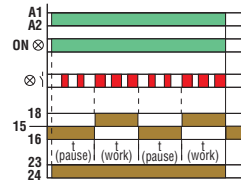
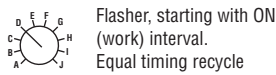
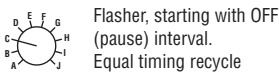
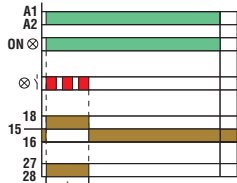
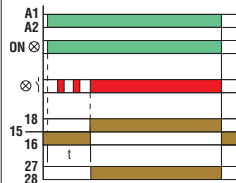
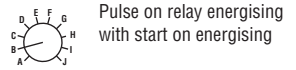
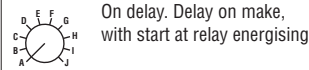
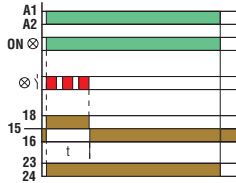
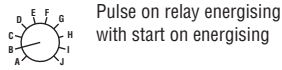
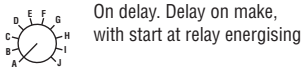
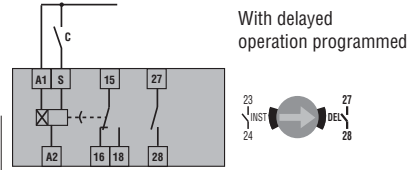
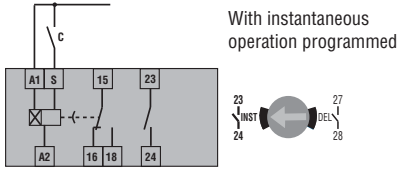



### TM PL

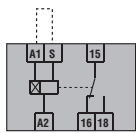

Flasher, starting with ON interval.  
Equal timing recycle, ON first

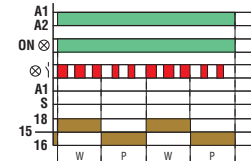

W = Work (ON)  
P = Pause (OFF)

Flasher, starting with OFF interval.  
Equal timing recycle, OFF first

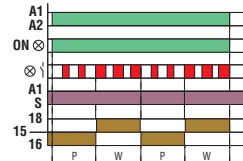

W = Work (ON)  
P = Pause (OFF)

### TM D

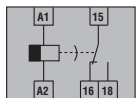

True off delay. Delay on break, starting at  
relay de-energising

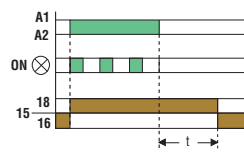

### TM ST

For starting

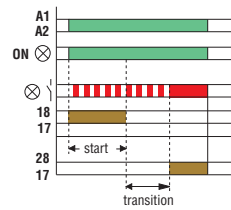
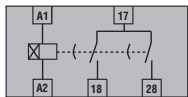

### TM LS

Staircase lighting

4-wire connection

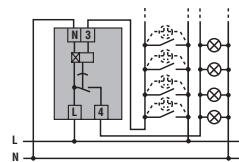

3-wire connection

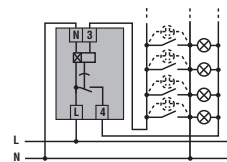

Timed lighting

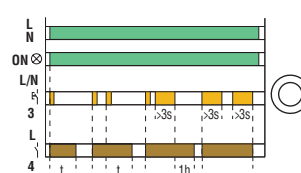

Constant lighting

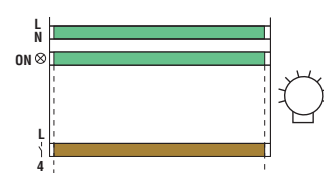

### L48TP...

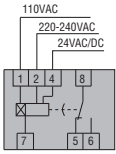

On delay

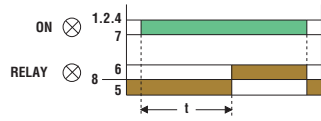

### L48TPB...

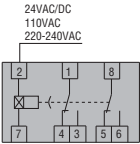

On delay with both instantaneous c/o contacts

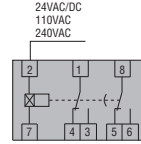
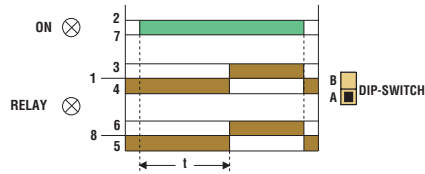

On delay with one instantaneous c/o contact and one late-break c/o contact

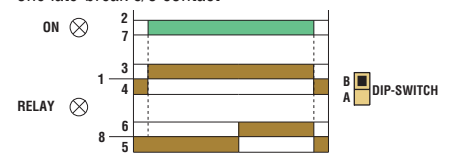

### L48M...

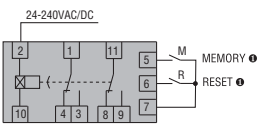

T (preset time) = T1+T2  
 ● Contacts "M" and "R" are to be volt free (dry).

On delay

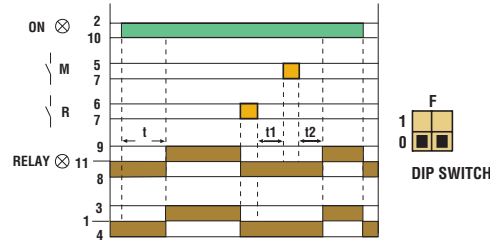

Pulse on relay energising with start on energising

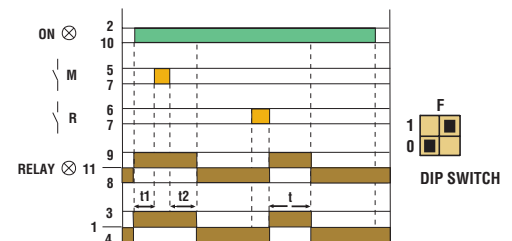

Flasher starting with OFF

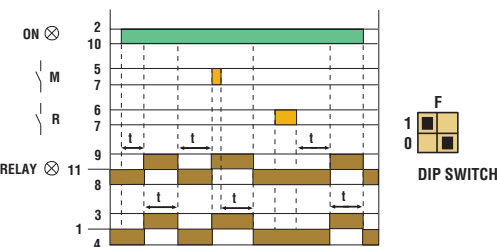

Flasher starting with ON

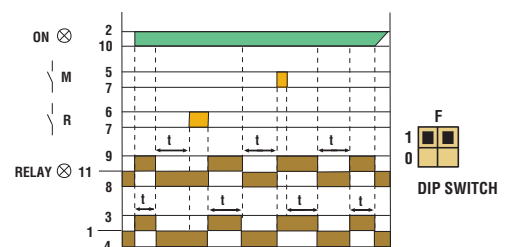

# 17 Time relays

Technical characteristics  
Modular version



TYPE	TM P	TM P A440	TM M1 - TM M2	TM M1 NFC	TM PL	TM D	TM ST	TM LS	
DESCRIPTION	On delay	On delay	Programmable multifunction	Programmable multifunction with NFC	Asymmetrical recycle	True off delay	For starting	Staircase illumination	
	Multiscale	Multiscale	Multiscale	Multiscale	Multiscale	Multiscale	Multiscale	Single scale	
	Multivoltage	Single voltage	Multivoltage	Multivoltage	Multivoltage	Multivoltage	Multivoltage	Single voltage	
CONTROL CIRCUIT									
Rated auxiliary supply voltage Us	24...48VDC 24...240VAC	380...440VAC	12...240VAC/DC			24...240VAC/DC	24...48VDC 24...240VAC 380...440VAC	220...240VAC	
Rated frequency	50/60Hz								
Operating voltage range	0.85...1.1 Us								
Power consumption (maximum)	1.2VA/0.8W max (24...48VAC/DC) 16VA/0.9W max (110...240VAC)	19VA/1.7W max	TM M1: 0.6VA/0.3W max (12...48VAC/DC) 1.6VA/1.2W max (110...240VAC/DC) TM M2: 1.1VA/0.8W max (12...48VAC/DC) 1.8VA/1.2W max (110...240VAC/DC)	0.6VA/0.3W max (12...48VAC/DC) 1.6VA/1.2W max (110...240VAC/DC)	0.6VA/0.3W max (12...48VAC/DC) 1.6VA/1.2W max (110...240VAC/DC)	0.1VA/0.1W (24...48VAC/DC) 1.1VA/0.8W (110...240VAC/DC)	1.2VA/0.8W max (24...48VAC/DC) 1.6VA/0.9W max (110...240VAC)Ⓛ	De-energised 5VA/0.5W max Energised 12VA/0.8W max	
TIMING CIRCUIT									
Time setting range	Multiscale 0.1...1s 1...10s 6s...60s 1...10min 6min...1h 1...10h 0,1...1day 1...10days ON only OFF only	Multiscale 0.1...1s 1...10s 6s...60s 1...10min	Multiscale 0.1...1s 1...10s 6s...60s 1...10min 6min...1h 1...10h 0.1...1day 1...10days ON only OFF only	Multiscale 0.1s...999h programmable via NFC and APP	Multiscale 0.1...1s 1...10s 6s...60s 1...10min 6min...1h 1h...10h 0.1...1gg 1...10gg 3...30gg 10...100gg	Multiscale 0.06...0.6s 0.6...6s 6s...60s 18s...180s	Multiscale 0.1...1s 1...10s 6s...60s 1...10min	Single scale 0.5...20min	
Setting accuracy	< ±9%		0			< ±9%			
Repeat accuracy	< ±0.1%	< ±0.5%	< ±0.5% - < ±0.2%	< ±0.1%	< ±0.2%	< ±0.5%			
Influence of voltage variation	< ±0.01%							< ±0.5%	
Average variation of set delays related to +20°C condition	< ±0.2%							< ±0.25%	
Minimum power time	—	—	—	—	—	≥ 200ms	—	—	
Minimum ON time	—	—	25ms (no maximum limit)			—	—	≥ 60ms (no max.lim.)	
Resetting during timing	≥ 100ms	≥ 100ms	≥ 100ms	≥ 100ms	≥ 100ms	—	≥ 100ms	≥ 100ms	
Resetting elapsed time	≥ 50ms	≥ 50ms	≥ 50ms	≥ 50ms	≥ 50ms	—	≥ 50ms	—	
Immunity time for microbreakings	≤ 50ms	—	≤ 25ms - ≤ 15ms	≤ 25ms	≤ 25ms	—	≤ 40msⓁ	≤ 20ms	
RELAY OUTPUTS									
Contact arrangement	1 delayed changeover	2 delayed changeover	TM M1: 1 delayed changeover TM M2: 1 inst./delayed N/O + 1 delayed c/o	1 delayed changeover	1 delayed changeover	1 delayed changeover	2 delayed N/O	1 delayed N/O	
Maximum switching voltage	250VAC								
IEC conventional free air thermal current (Ith)	8A	8A	8A	8A	8A	5A	8A	16A	
UL/GSA and IEC/EN 60947-5-1 designation	B300							(16A AC1 240VAC)	
Electrical life (with rated load)	10 <sup>5</sup> cycles								
Mechanical life	30x10 <sup>6</sup> cycles								
Tightening torque maximum	max. 0.8Nm (7lbin; 7...9lbin per UL)								
Conductor section min-max	0.2...4mm <sup>2</sup> (24...12 AWG; 12...18 AWG per UL)								
INSULATION (input-output)									
IEC rated insulation voltage	250V								
IEC rated impulse withstand voltage	4kV								
IEC power frequency withstand voltage	2kV								
AMBIENT CONDITIONS									
Operating temperature	-20...+60°C								
Storage temperature	-30...+80°C								
Housing material	Self-extinguishing polyamide								

Ⓛ For 380...440VAC types: 19VA/1.7W max. Ⓛ Used at 24...48VDC or 24...240VAC; ≤30ms at 380...440VAC.

NOTE: N/O = normally open / SPST c/o = changeover / SPDT; inst. = instantaneous.

# 17 Time relays

Technical characteristics

Plug-in and flush mount version 48x48mm/1.9x1.9"

TYPE	L48TP...	L48TPB...	L48M...
<b>DESCRIPTION</b>			
	On delay	On delay	Programmable multifunction
	Multiscale	Multiscale	Multiscale
	Multivoltage	Single voltage	Multivoltage
<b>CONTROL CIRCUIT</b>			
Rated supply voltage $U_s$	24VAC/DC❶	24VAC/DC❶ 220...240VAC❶	24...240VAC/DC❶
	110VAC❶		
	220...240VAC❶		
Rated frequency	50...60Hz		
Operating voltage range	0.85...1.1 $U_s$		
Power consumption (maximum)	6VA		
Power dissipation (maximum)	❷		
<b>TIMING CIRCUIT</b>			
Time setting range	Multiscale	Multiscale	Multiscale
	0.3...3s	0.05...1s	0.05...1s
	1.2...12s	0.10...10s	0.1...10s
	10...100s	0.6s...1min	0.6s...1min
	7.8...780s	6s...10min	6s...10min
	18s...3min		0.05...1min
	72s...12min		0.1...10min
	10...100min		0.6min...1h
78...780min		1min...10h	
Setting accuracy	±5%		
Repeat accuracy	±0.5%		
Influence of voltage variation	±0,5%		
Average variation of set delays in related to 20°C condition	at -20°C	+2%	
	at +60°C	-3%	
Minimum ON time	—		
Resetting time	during operation	≥ 0.1s	≥ 0.1s
	elapsed time	≥ 65ms	≥ 65ms
Immunity time for microbreakings	≤ 40ms	≤ 40ms	≤ 40ms
<b>RELAY OUTPUTS</b>			
Number of relays	1	2	2
Contact arrangement	1 delayed c/o	2 del. or 1 inst. + 1 del. c/o	2 delayed c/o
Maximum switching voltage	250V		
IEC conventional free air thermal current (I <sub>th</sub> )	5A		
UL/CSA and IEC/EN 60947-5-1 designation	B300		
Electrical life (with rated load)	10 <sup>9</sup> cycles		
Mechanical life	30x10 <sup>6</sup> cycles		
<b>CONNECTIONS</b>			
Tightening torque maximum	—		
Conductor section (min-max)	—		
<b>INSULATION (input-output)</b>			
IEC rated insulation voltage $U_i$	250V		
IEC power frequency withstand voltage $U_{imp}$	—		
IEC power frequency withstand voltage	2kV		
<b>AMBIENT CONDITIONS</b>			
Operating temperature	-10...+60°C		
Storage temperature	-30...+80°C		
Housing material	Self-extinguishing polyamide		

❶ Other voltages on request.

❷ Consult Technical support for information; see contact details on inside front cover.

NOTE: del. = delayed inst. = instantaneous c/o = changeover/SPDT