

Three Phase Bridge + Thyristor

VRRM / VDRM 800 to 1800V
IFAV / ITAV 75A

Features

- Blocking voltage:800 to 1800V
- Three Phase Bridge and a Thyristor
- Isolated Module package

Applications

- Inverter for AC or DC motor control
- Current stabilized power supply
- Switching power supply
- UL recognized applied for file no. E360040

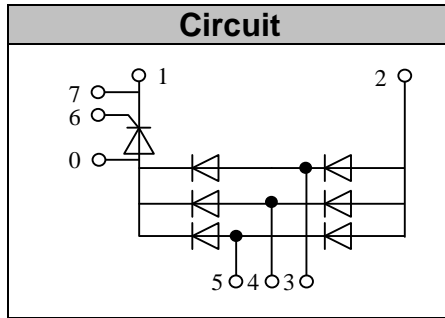

Module Type

| TYPE | VRRM /VDRM | VRSM |
|------------|------------|-------|
| MT75DT08L1 | 800V | 900V |
| MT75DT12L1 | 1200V | 1300V |
| MT75DT16L1 | 1600V | 1700V |
| MT75DT18L1 | 1800V | 1900V |

◆ Diode

Maximum Ratings

| Symbol | Item | Conditions | Values | Units |
|------------------|------------------------------------|--------------------------------|-------------|------------------|
| ID | Output Current(D.C.) | Tc=101°C Three phase full wave | 75 | A |
| IFSM | Surge forward current | t=10mS Tvj =45°C | 920 | A |
| i ² t | Circuit Fusing Consideration | | 4200 | A ² s |
| Visol | Isolation Breakdown Voltage(R.M.S) | a.c.50HZ;r.m.s.;1min | 3000 | V |
| Tvj | Operating Junction Temperature | | -40 to +150 | °C |
| Tstg | Storage Temperature | | -40 to +125 | °C |
| Mt | Mounting Torque | To terminals(M5) | 3±15% | Nm |
| Ms | | To heatsink(M5) | 3±15% | Nm |
| Weight | | Module (Approximately) | 210 | g |

Thermal Characteristics

| Symbol | Item | Conditions | Values | Units |
|----------|-------------------------|-------------------------|--------|-------|
| Rth(j-c) | Thermal Impedance, max. | Junction to Case(TOTAL) | 0.20 | °C/W |
| Rth(c-s) | Thermal Impedance, max. | Case to Heatsink | 0.10 | °C/W |

Electrical Characteristics

| Symbol | Item | Conditions | Values | Units |
|--------|---------------------------------------|---|------------|----------|
| VFM | Forward Voltage Drop, max. | T=25°C IF =100A | 1.40 | V |
| IRRM | Repetitive Peak Reverse Current, max. | Tvj =25°C VRD=VRRM Tvj =150°C VRD=VRRM | ≤0.5 ≤6 | mA mA |



◆ Thyristor Maximum Ratings

| Symbol | Item | Conditions | Values | Units |
|-----------|--|--|-------------|------------------------|
| I_{TAV} | Average On-State Current | $T_c=99^{\circ}\text{C}$, Single Phase half wave 180° conduction | 75 | A |
| I_{TSM} | Surge On-State Current | $T_{VJ}=45^{\circ}\text{C}$ $t=10\text{ms}$ (50Hz), sine $V_R=0$ | 920 | A |
| i^2t | Circuit Fusing Consideration | | 4200 | A^2s |
| Visol | Isolation Breakdown Voltage(R.M.S) | a.c.50HZ;r.m.s.;1 min | 3000 | V |
| T_{vj} | Operating Junction Temperature | | -40 to +125 | $^{\circ}\text{C}$ |
| T_{stg} | Storage Temperature | | -40 to +125 | $^{\circ}\text{C}$ |
| M_t | Mounting Torque | To terminals(M5) | $3\pm 15\%$ | Nm |
| M_s | | To heatsink(M5) | $3\pm 15\%$ | Nm |
| di/dt | Critical Rate of Rise of On-State Current | $T_{VJ}=T_{VJM}$, $V_D=1/2V_{DRM}$, $I_G=100\text{mA}$ $d_{iG}/d_t=0.1\text{A}/\mu\text{s}$ | 150 | $\text{A}/\mu\text{s}$ |
| dv/dt | Critical Rate of Rise of Off-State Voltage, min. | $T_J=T_{VJM}$, $V_D=2/3V_{DRM}$, linear voltage rise | 500 | $\text{V}/\mu\text{s}$ |

Electrical and Thermal Characteristics

| Symbol | Item | Conditions | Values | | | Units |
|-------------------|---|--|--------|------|------|-----------------------------|
| | | | Min. | Typ. | Max. | |
| V_{TM} | Peak On-State Voltage, max. | $T=25^{\circ}\text{C}$ $I_T=100\text{A}$ | | | 1.30 | V |
| I_{RRM}/I_{DRM} | Repetitive Peak Reverse Current, max. / Repetitive Peak Off-State Current, max. | $T_{VJ}=T_{VJM}$, $V_R=V_{RRM}$, $V_D=V_{DRM}$ | | | 20 | mA |
| V_{GT} | Gate Trigger Voltage, max. | $T_{VJ}=25^{\circ}\text{C}$, $V_D=6\text{V}$ | | | 3 | V |
| I_{GT} | Gate Trigger Current, max. | $T_{VJ}=25^{\circ}\text{C}$, $V_D=6\text{V}$ | | | 150 | mA |
| $R_{th(j-c)}$ | Thermal Impedance, max. | Junction to Case | | | 0.30 | $^{\circ}\text{C}/\text{W}$ |
| $R_{th(c-s)}$ | Thermal Impedance, max. | Case to Heatsink | | | 0.10 | $^{\circ}\text{C}/\text{W}$ |



Performance Curves

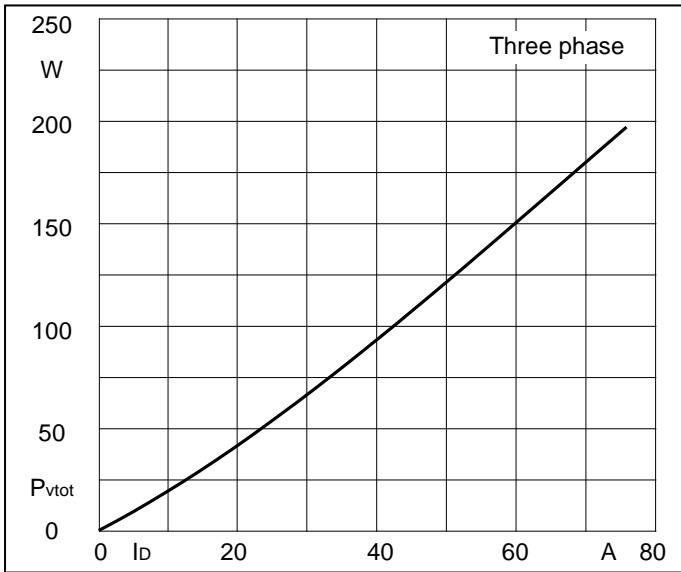

Fig1. Power dissipation

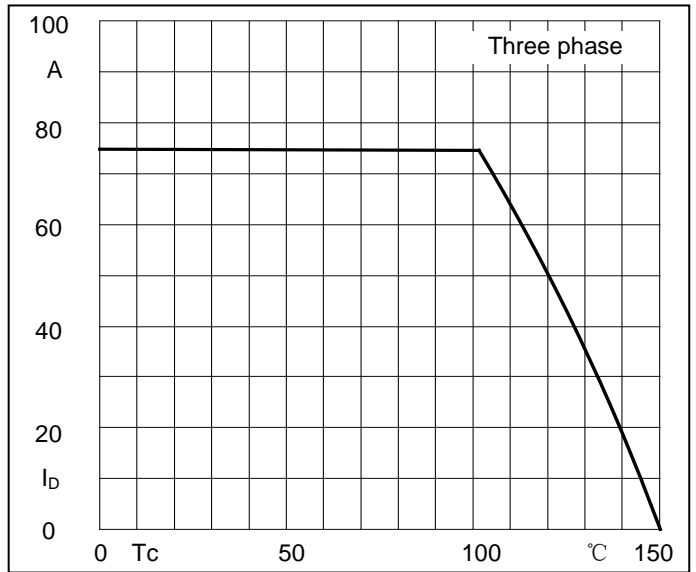

Fig2. Forward Current Derating Curve

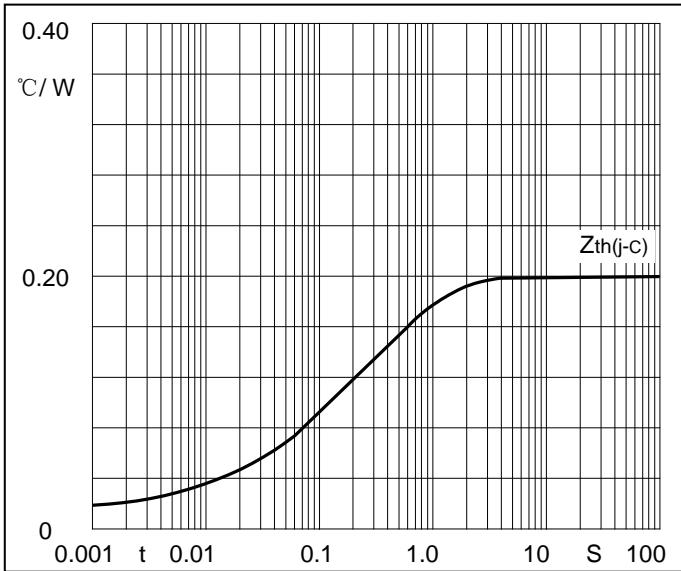

Fig3. Transient thermal impedance

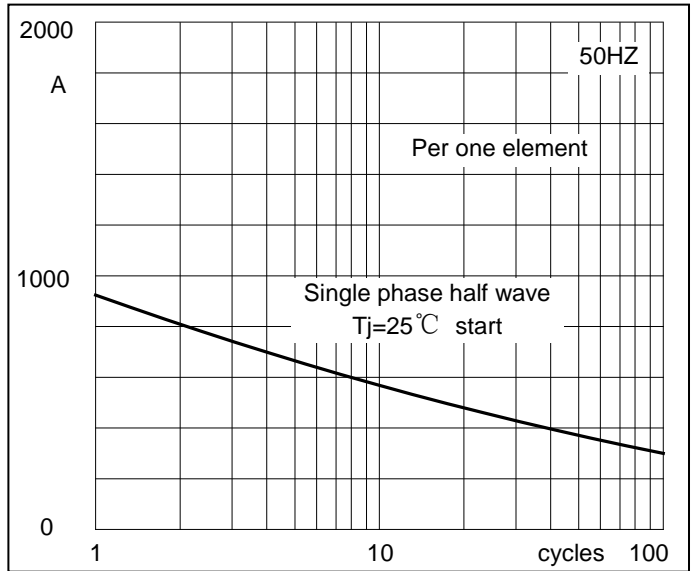

Fig4. Max Non-Repetitive Forward Surge Current

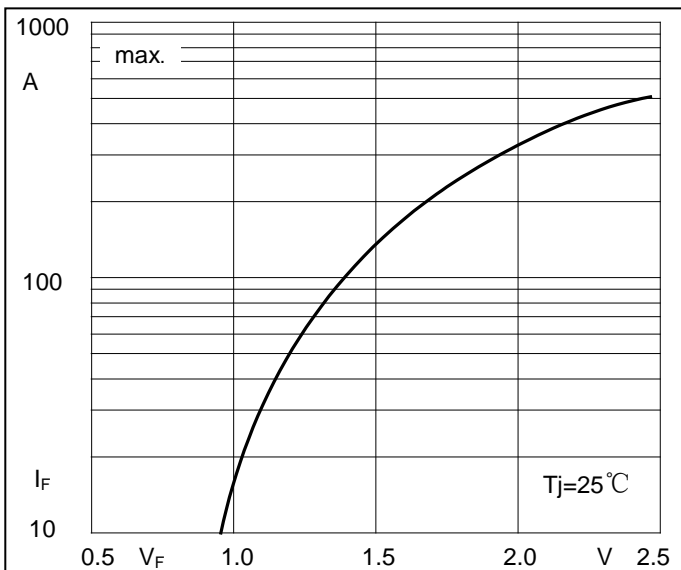

Fig5. Forward Characteristics

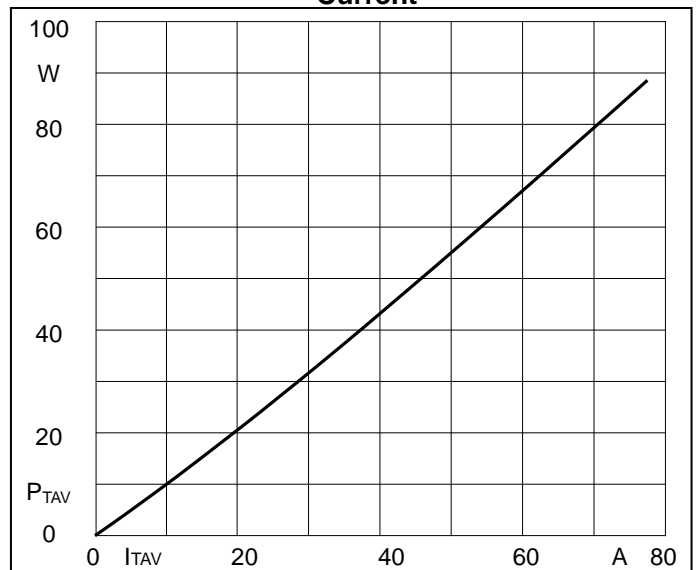

Fig6. SCR Power dissipation

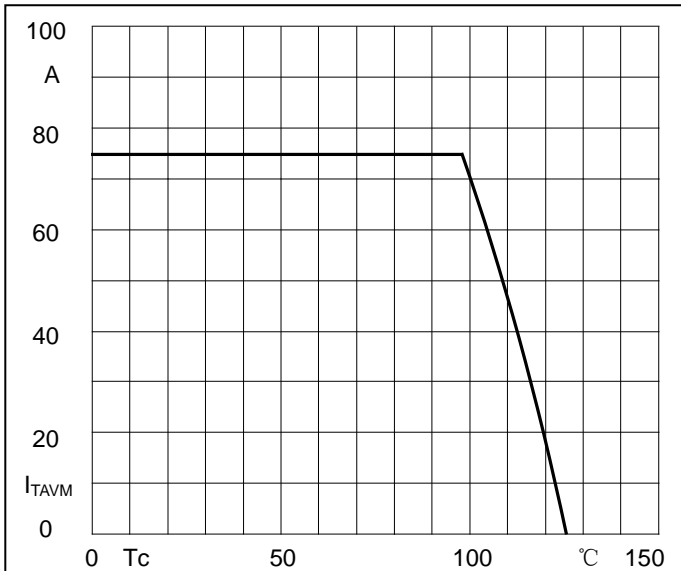

Fig7. SCR Forward Current Derating Curve

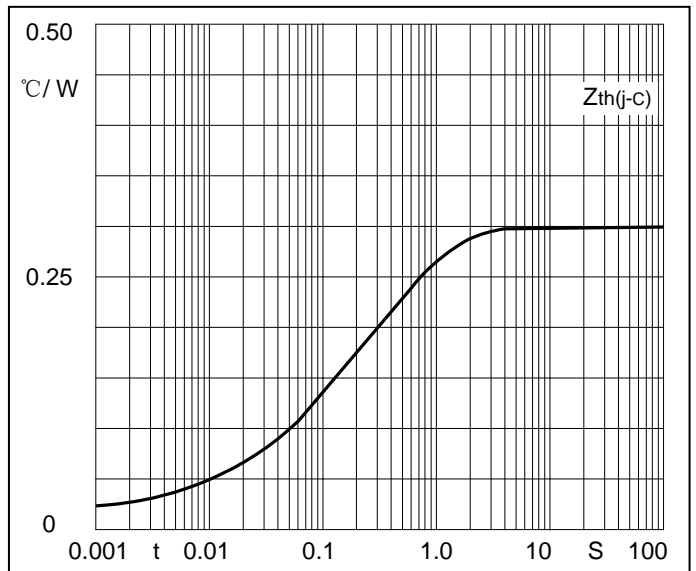

Fig8. SCR Transient thermal impedance

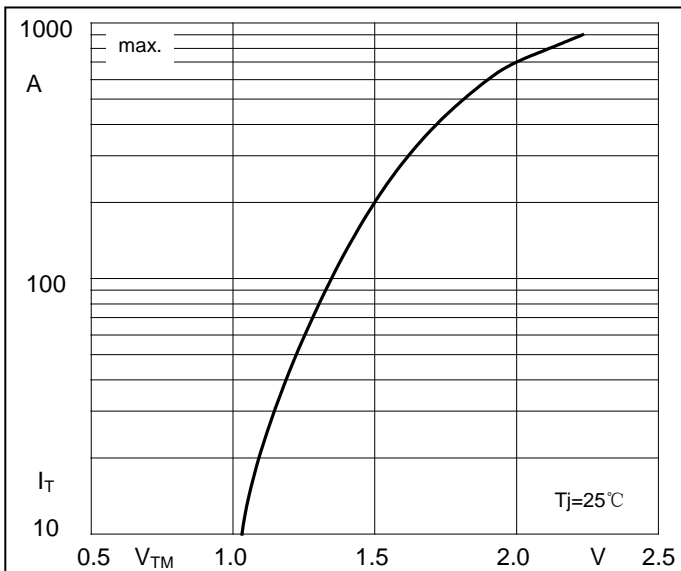

Fig9. SCR Forward Characteristics

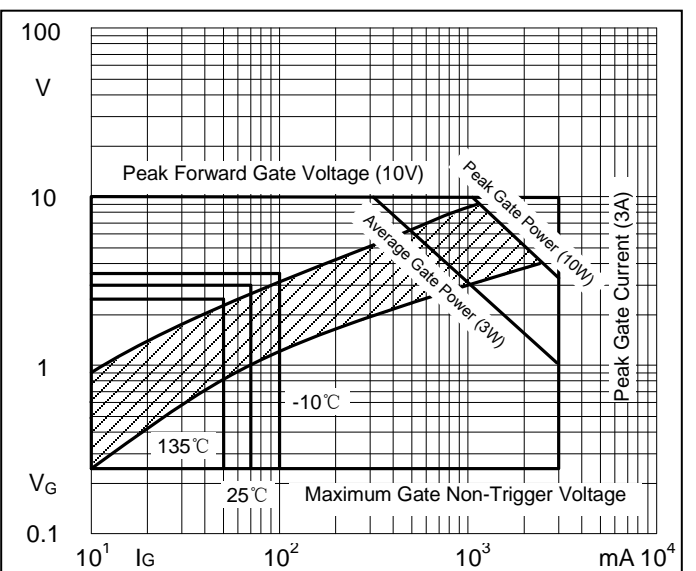

Fig10. Gate trigger Characteristics

Package Outline Information

