

Features :

- Isolated mounting base 2500V~
- Pressure contact technology with Increased power cycling capability
- Space and weight saving

Typical Applications

- Various rectifiers
- DC supply for PWM inverter

V _{RSM}	V _{RPM}	Type & Outline
900V	800V	MDx380-08
1100V	1000V	MDx380-10
1300V	1200V	MDx380-12
1500V	1400V	MDx380-14
1700V	1600V	MDx380-16
1900V	1800V	MDx380-18

SYMBOL	CHARACTERISTIC	TEST CONDITIONS	T _J (°C)	VALUE			UNIT
				Min	Type	Max	
I _{F(AV)}	Mean forward current	180° half sine wave 50Hz Single side cooled, T _C =100°C	150			380	A
I _{F(RMS)}	RMS forward current		150			596	A
I _{RPM}	Repetitive peak current	at V _{RPM}	150			20	mA
I _{FSM}	Surge forward current	10ms half sine wave	150			9.8	KA
I ² t	I ² T for fusing coordination	V _R =0.6V _{RPM}				451	A ² s*10 ³
V _{FO}	Threshold voltage		150			0.72	V
r _F	Forward slop resistance					0.40	mΩ
V _{FM}	Peak forward voltage	I _{FM} =1100A	25			1.45	V
R _{th(j-c)}	Thermal resistance Junction to case	At 180° sine Single side cooled per chip				0.120	°C /W
R _{th(c-h)}	Thermal resistance case to heatsink	At 180° sine Single side cooled per chip				0.04	°C /W
V _{iso}	Isolation voltage	50Hz, R.M.S, t=1min, I _{iso} :1mA(max)		2500			V
F _m	Terminal connection torque(M8)				12.0		N·m
	Mounting torque(M6)				6.0		N·m
T _{stg}	Stored temperature			-40		125	°C
W _t	Weight				550		g
Outline	M03Y						

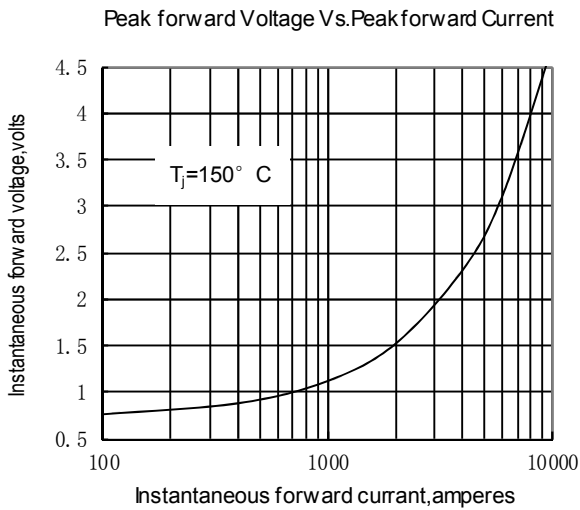

Fig.1

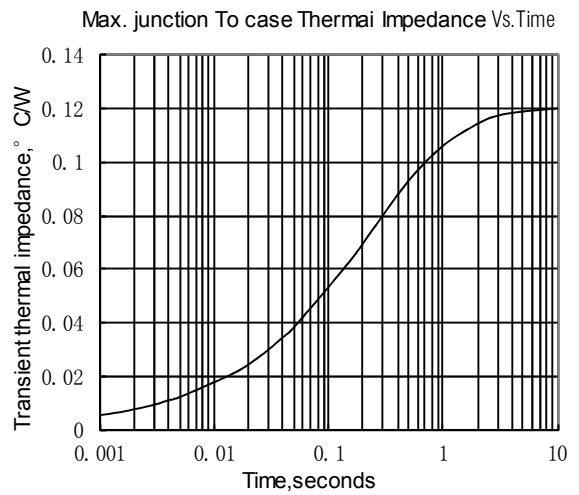

Fig.2

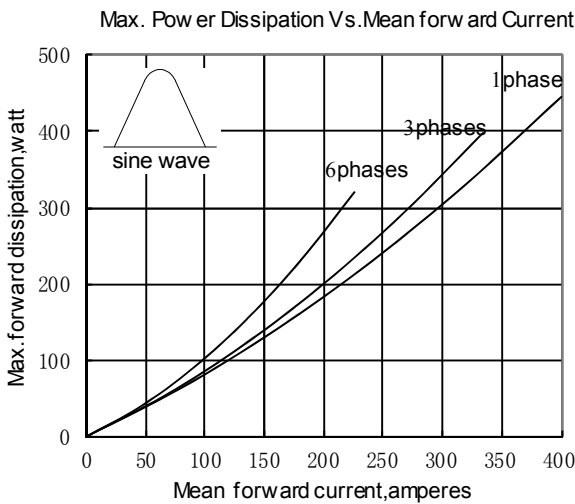

Fig.3

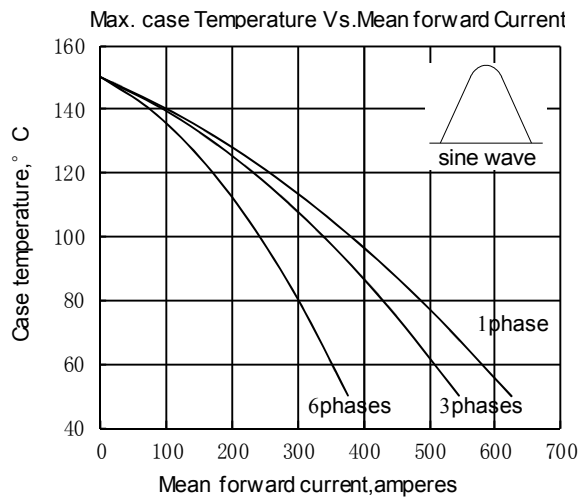

Fig.4

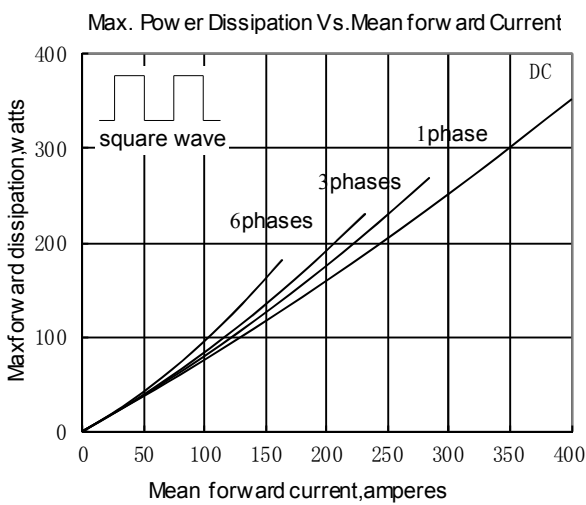

Fig.5

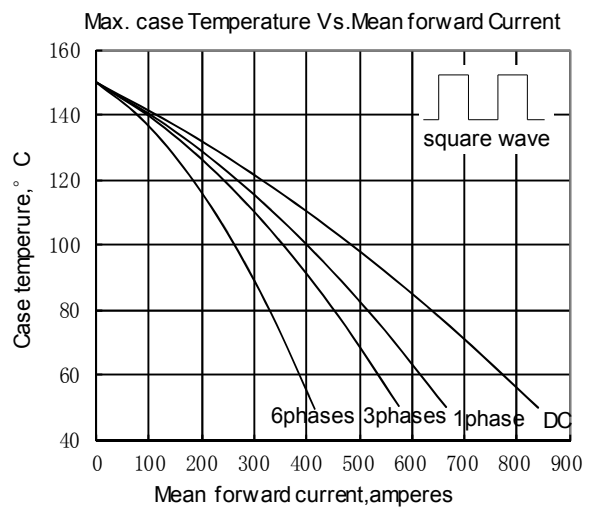

Fig.6

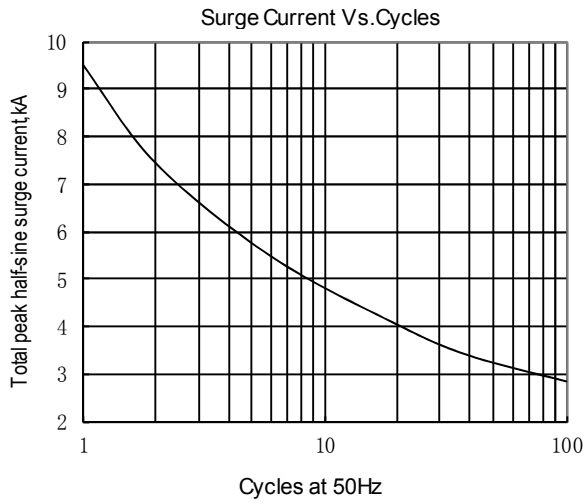

Fig.7

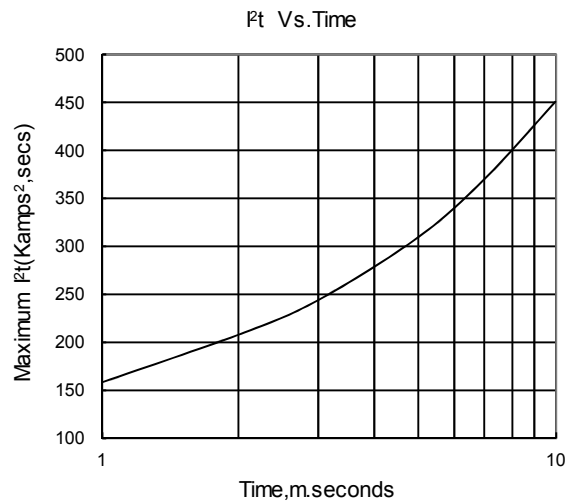
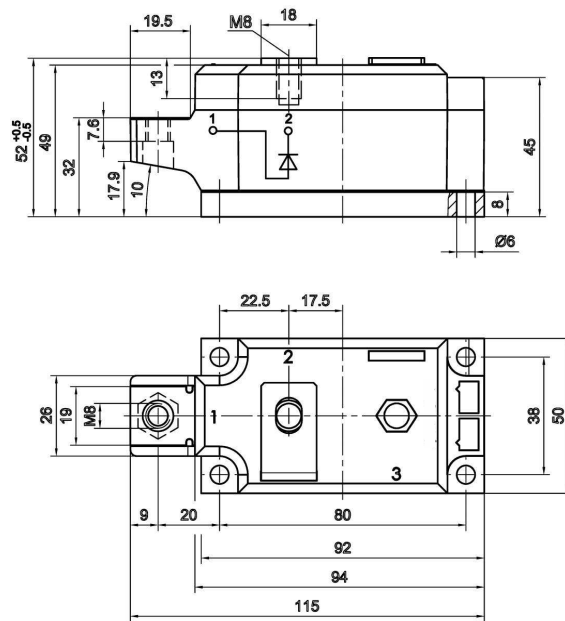

Fig.8

Outline:



M03Y

