



Catalytic Flammable Gas Sensor

(Model: MC107)

User's Manual

Version: 1.1

Valid from: 2017-05-23

Zhengzhou Winsen Electronics Technology Co., Ltd

Statement

This manual copyright belongs to Zhengzhou Winsen Electronics Technology Co., LTD. Without the written permission, any part of this manual shall not be copied, translated, stored in database or retrieval system, also can't spread through electronic, copying, record ways.

Thanks for purchasing our product. In order to let customers use it better and reduce the faults caused by misuse, please read the manual carefully and operate it correctly in accordance with the instructions. If users disobey the terms or remove, disassemble, change the components inside of the sensor, we shall not be responsible for the loss.

The specific such as color, appearance, sizes ...etc., please in kind prevail.

We are devoting ourselves to products development and technical innovation, so we reserve the right to improve the products without notice. Please confirm it is the valid version before using this manual. At the same time, users' comments on optimized using way are welcome.

Please keep the manual properly, in order to get help if you have questions during the usage in the future.

Zhengzhou Winsen Electronics Technology CO., LTD

MC107 Catalytic Flammable Gas Sensor

Profile

MC107 adopts catalytic combustion principle, and its two arms of electric bridge consists of a test element and a compensate element. The resistance of the test element rises once it meets the combustible gases, in the same time, the output voltage of the bridge changes and the voltage variation rises in direct proportion to the gas concentration. The compensate element, as a conference, has the function of compensating temperature and humidity.



Features

- Bridge output voltage in linear
- Fast response
- Good repeatability and selectivity
- Stable and reliable
- Resist H₂S poisoning & organosilicone.

Main Applications

It is widely used in industrial occasion to detect the concentration of natural gas. It is also used in combustible gas leakage alarm, combustible gas detector and gas concentration meter.

Parameters

Model	MC107	
Sensor Type	Catalytic Type	
Standard Encapsulation	Metal cap & Plastic base	
Working voltage(V)	2.5 ± 0.1	
Working current(mA)	150 ± 10	
Sensitivity (mV)	1% CH ₄	15 ~ 45
Linearity	≤ 5%	
Measuring range(%LEL)	0 ~ 100	
Response Time (90%)	≤ 10s	
Recovery Time (90%)	≤ 30s	
Operation Environment	-40 ~ +70 °C < 95%RH	
Storage Environment	-20 ~ +70 °C < 95%RH	

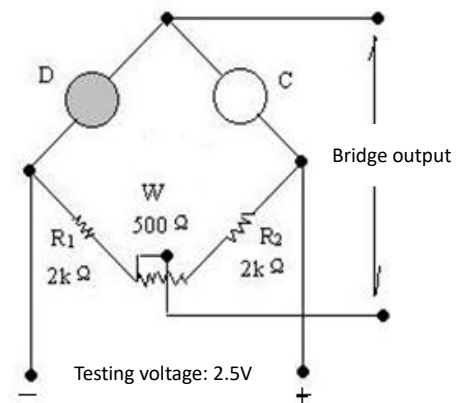
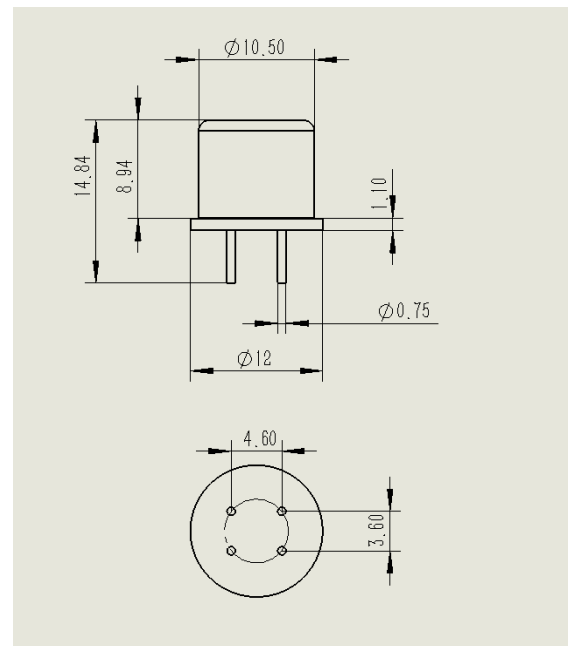

Fig2. Basic Test Circuit

Sensitivity and Response Feature

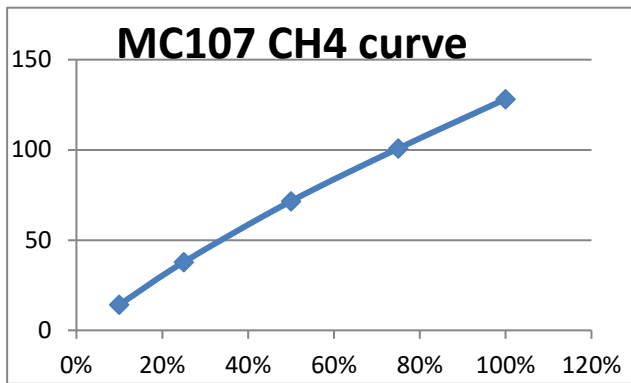

Fig3.Sensitivity Curve

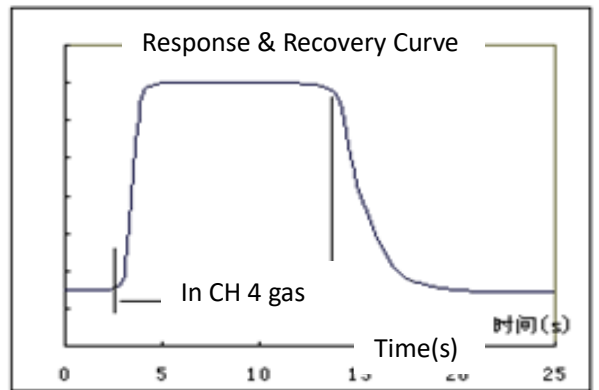

Fig4. Response and Recovery Curve

Changing of output signal at different temperature:

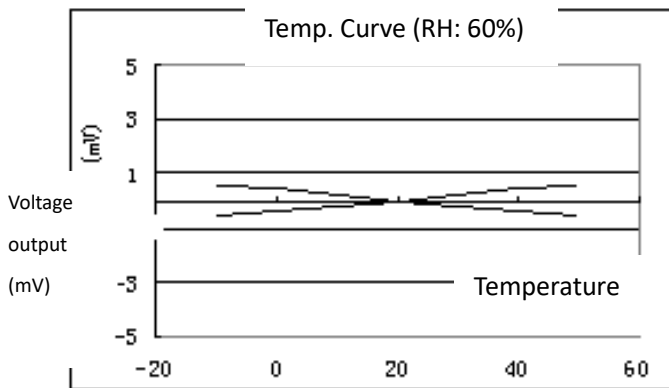

Fig5.Zero point at different temp.

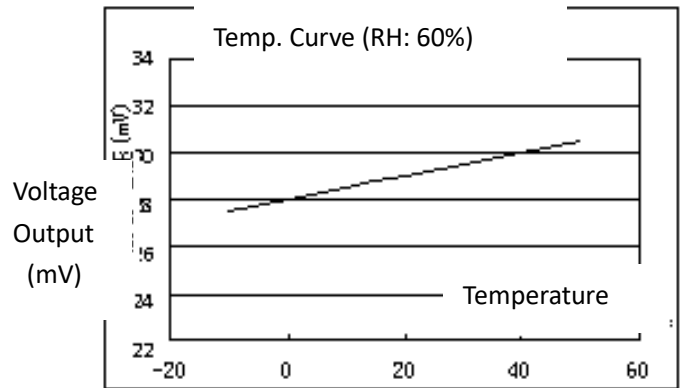

Fig6. Sensitivity at different temp.

Changing of output signal at different humidity:

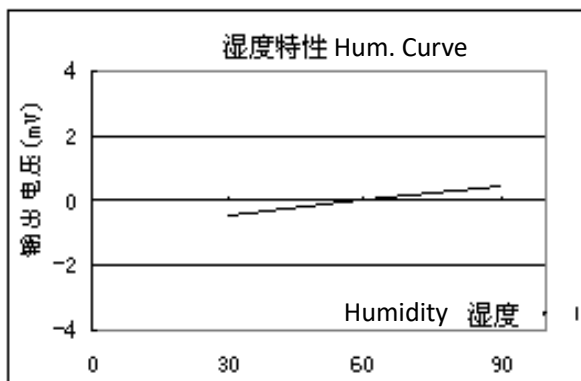

Fig7.Zero point at different

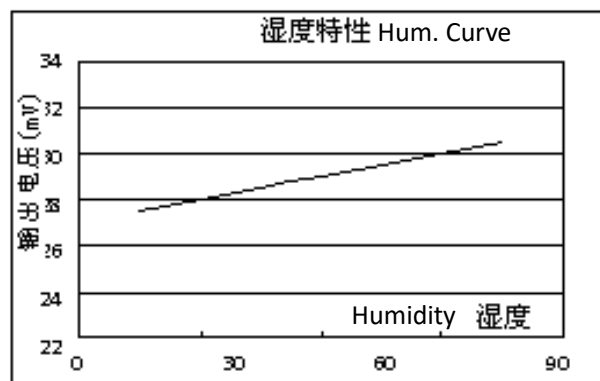

Fig8. Sensitivity at different humidity

Changing of output signal with different voltage supplying:

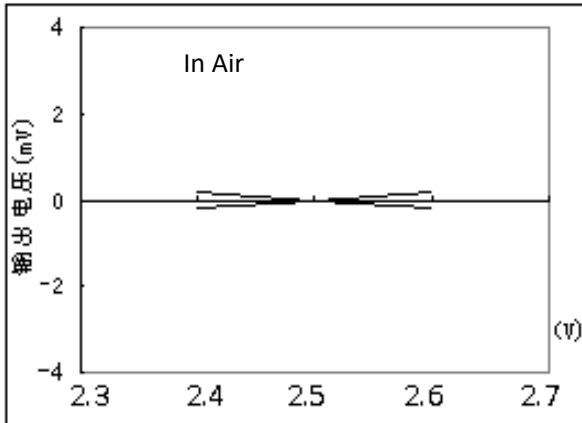

Fig9. Zero Drift with different voltage

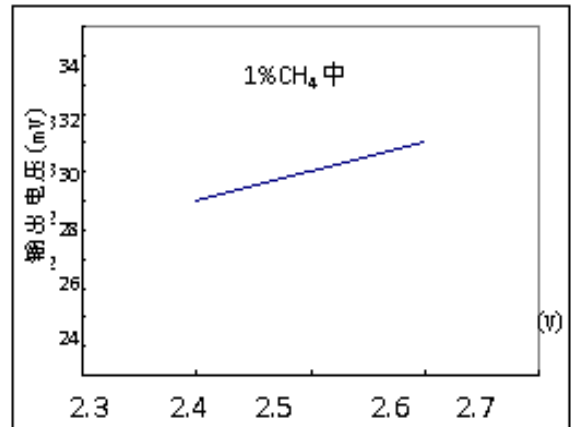

Fig10. Sensitivity with different voltage

Long-term Stability

The drift in air per year is within $\pm 2\text{mV}$, in $1\%\text{CH}_4$ is within $\pm 2\text{mV}$. For a short period storage (in 2 weeks), the sensor need burn-in continuously for 8 hours to reach stability. For more than one year storage, it need more than 48 hours.

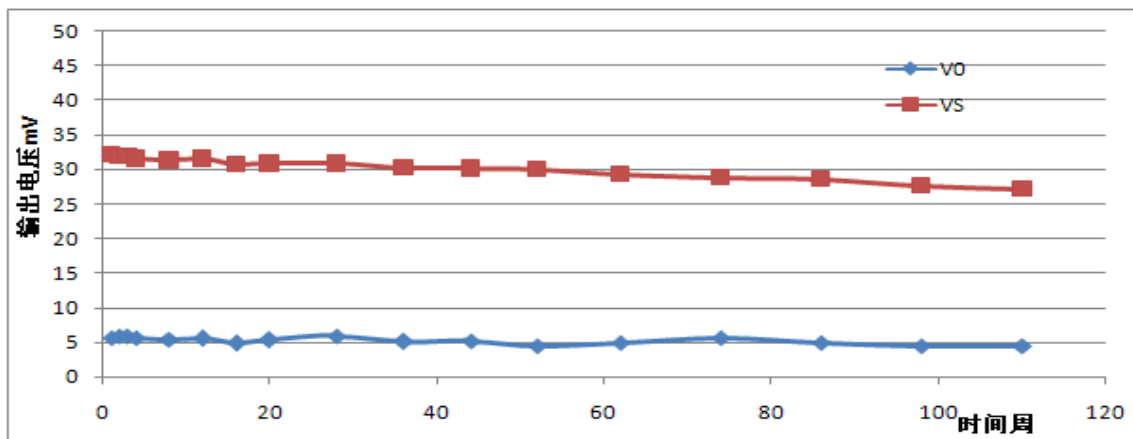

Fig11. Stability of Zero point and Sensitivity

Cautions

1. Following conditions must be prohibited

- 1.1 Exposed to organic silicon steam
 Sensing material will lose sensitivity and never recover if the sensor absorbs organic silicon steam. Sensors must avoid exposing to silicon bond, fixture, silicon latex, putty or plastic contain silicon environment.
- 1.2 High Corrosive gas
 If the sensors are exposed to high concentration corrosive gas (such as H_2S , SO_x , Cl_2 , HCl etc.), it will not only result in corrosion of sensors structure, also it cause sincere sensitivity attenuation.
- 1.3 Alkali, Alkali metals salt, halogen pollution
 The sensors performance will be changed badly if sensors be sprayed polluted by alkali metals salt especially brine, or be exposed to halogen such as fluorine.
- 1.4 Touch water
 Sensitivity of the sensors will be reduced when splattered or dipped in water.
- 1.5 Freezing

Do avoid icing on sensor's surface, otherwise sensing material will be broken and lost sensitivity.

1.6 Applied higher voltage

Applied voltage on sensor should not be higher than stipulated value, even if the sensor is not physically damaged or broken, it causes down-line or heater damaged, and bring on sensors' sensitivity characteristic changed badly.

1.7 Pins connection

When the sensor is connecting to the circuit, one of detection part pins and one of compensation part pins connects as the signal output. The other pin of detection part connects negative electrode, while the other pin of compensation part connects positive electrode. The part with "D" mark on the sensor bottom is the detection one, the other part with "C" mark is the compensation one.

2 .Following conditions must be avoided

2.1 Water Condensation

Indoor conditions, slight water condensation will influence sensors' performance lightly. However, if water condensation on sensors surface and keep a certain period, sensors' sensitive will be decreased.

2.2 Used in high gas concentration

No matter the sensor is electrified or not, if it is placed in high gas concentration for long time, sensors characteristic will be affected. If lighter gas sprays the sensor, it will cause extremely damage.

2.3 Long time storage

The sensors resistance will drift reversibly if it's stored for long time without electrify, this drift is related with storage conditions. Sensors should be stored in airproof bag without volatile silicon compound. For the sensors with long time storage but no electrify, they need long galvanical aging time for stability before using. The suggested aging time is 24 hours at least if the storage time is more than half an year.

2.4 Long time exposed to adverse environment

No matter the sensors electrified or not, if exposed to adverse environment for long time, such as high humidity, high temperature, or high pollution etc., it will influence the sensors' performance badly.

2.5 Vibration

Continual vibration will result in sensors down-lead response then break. In transportation or assembling line, pneumatic screwdriver/ultrasonic welding machine can lead this vibration.

2.6 Concussion

If sensors meet strong concussion, it may lead its lead wire disconnected.

2.7 Usage Conditions

2.7.1 For sensor, handmade welding is optimal way. The welding conditions as follow:

- Soldering flux: Rosin soldering flux contains least chlorine
- Homothermal soldering iron
- Temperature: 250°C
- Time: less than 3 seconds

2.7.2 If users choose wave-soldering, the following conditions should be obey:

- Soldering flux: Rosin soldering flux contains least chlorine
- Speed: 1-2 Meter/ Minute
- Warm-up temperature: 100±20°C
- Welding temperature: 250±10°C
- One time pass wave crest welding machine

If disobey the above using terms, sensors sensitivity will be reduced.