

Digital Storage Oscilloscope

GDS-2000A Series

USER MANUAL

GW INSTEK PART NO. 82DS-2304AEE1



ISO-9001 CERTIFIED MANUFACTURER

GW INSTEK

This manual contains proprietary information, which is protected by copyright. All rights are reserved. No part of this manual may be photocopied, reproduced or translated to another language without prior written consent of Good Will company.

The information in this manual was correct at the time of printing. However, Good Will continues to improve products and reserves the rights to change specification, equipment, and maintenance procedures at any time without notice.

Good Will Instrument Co., Ltd.
No. 7-1, Jhongsing Rd., Tucheng Dist., New Taipei City 236, Taiwan

Table of Contents

SAFETY INSTRUCTIONS	5
GETTING STARTED	10
GDS-2000A Series Overview	11
Appearance	16
Set Up	29
QUICK REFERENCE	41
Menu Tree / Operation Shortcuts	43
Default Settings	61
Built-in Help	63
MEASUREMENT	64
Basic Measurement	65
Automatic Measurement	72
Cursor Measurement	85
Math Operation	93
CONFIGURATION	101
Acquisition	103
Segmented Memory Acquisition Overview	111
Display	124
Horizontal View	130
Vertical View (Channel)	137
Trigger	144
Search	163
System Info / Language / Clock	168
OPTIONAL SOFTWARE and APPS.	174
Applications	175

Optional Software	182
SAVE/RECALL	185
File Format/Utility	186
Create/Edit Labels.....	191
Save	195
Recall	202
Reference Waveforms	209
FILE UTILITIES.....	211
HARDCOPY KEY.....	218
REMOTE CONTROL CONFIG	222
Interface Configuration	223
Web Server	238
MAINTENANCE	241
FAQ	246
APPENDIX	249
GDS-2000A Specifications.....	249
Probe Specifications	254
GDS-2000A Dimensions.....	256
Declaration of Conformity	257
INDEX.....	258

S SAFETY INSTRUCTIONS

This chapter contains important safety instructions that you must follow during operation and storage. Read the following before any operation to insure your safety and to keep the instrument in the best possible condition.

Safety Symbols

These safety symbols may appear in this manual or on the GDS-2000A.



WARNING

Warning: Identifies conditions or practices that could result in injury or loss of life.



CAUTION

Caution: Identifies conditions or practices that could result in damage to the GDS-2000A or to other properties.



DANGER High Voltage



Attention Refer to the Manual



Protective Conductor Terminal



Earth (ground) Terminal



Do not dispose electronic equipment as unsorted municipal waste. Please use a separate collection facility or contact the supplier from which this instrument was purchased.

Safety Guidelines

General Guideline



CAUTION

- Make sure the BNC input voltage does not exceed 300Vrms.
- Never connect a hazardous live voltage to the ground side of the BNC connectors. It might lead to fire and electric shock.
- Do not place any heavy object on the GDS-2000A.
- Avoid severe impact or rough handling that leads to damaging the GDS-2000A.
- Do not discharge static electricity to the GDS-2000A.
- Use only mating connectors, not bare wires, for the terminals.
- Do not block the cooling fan opening.
- Do not perform measurement at a power source or building installation site (Note below).
- Do not disassemble the GDS-2000A unless you are qualified.

(Measurement categories) EN 61010-1:2010 specifies the measurement categories and their requirements as follows. The GDS-2000A falls under category I.

- Measurement category IV is for measurement performed at the source of low-voltage installation.
- Measurement category III is for measurement performed in the building installation.
- Measurement category II is for measurement performed on the circuits directly connected to the low voltage installation.
- Measurement category I is for measurements performed on circuits not directly connected to Mains.

Power Supply	<ul style="list-style-type: none">• AC Input voltage: 100 ~ 240V AC, 48 ~ 63Hz, auto selection. Power consumption: 96VA.• Connect the protective grounding conductor of the AC power cord to an earth ground, to avoid electrical shock.
 WARNING	
Cleaning the GDS-2000A	<ul style="list-style-type: none">• Disconnect the power cord before cleaning.• Use a soft cloth dampened in a solution of mild detergent and water. Do not spray any liquid.• Do not use chemicals containing harsh materials such as benzene, toluene, xylene, and acetone.
Operation Environment	<ul style="list-style-type: none">• Location: Indoor, no direct sunlight, dust free, almost non-conductive pollution (Note below)• Relative Humidity: $\leq 80\%$, 40°C or below; $\leq 45\%$, $41^{\circ}\text{C} \sim 50^{\circ}\text{C}$• Altitude: $< 2000\text{m}$• Temperature: 0°C to 50°C <p>(Pollution Degree) EN 61010-1:2001 specifies the pollution degrees and their requirements as follows. The GDS-2000A falls under degree 2.</p> <p>Pollution refers to “addition of foreign matter, solid, liquid, or gaseous (ionized gases), that may produce a reduction of dielectric strength or surface resistivity”.</p> <ul style="list-style-type: none">• Pollution degree 1: No pollution or only dry, non-conductive pollution occurs. The pollution has no influence.• Pollution degree 2: Normally only non-conductive pollution occurs. Occasionally, however, a temporary conductivity caused by condensation must be expected.• Pollution degree 3: Conductive pollution occurs, or dry, non-conductive pollution occurs which becomes conductive due to condensation which is expected. In such conditions, equipment is normally protected against exposure to direct sunlight, precipitation, and full wind pressure, but neither temperature nor humidity is controlled.
Storage environment	<ul style="list-style-type: none">• Location: Indoor• Temperature: -10°C to 60°C $40^{\circ}\text{C} / 93\% \text{ RH}$ $41^{\circ}\text{C} \sim 60^{\circ}\text{C} / 65\% \text{ RH}$

Disposal

Do not dispose this instrument as unsorted municipal waste. Please use a separate collection facility or contact the supplier from which this instrument was purchased. Please make sure discarded electrical waste is properly recycled to reduce environmental impact.

Power cord for the United Kingdom

When using the oscilloscope in the United Kingdom, make sure the power cord meets the following safety instructions.

NOTE: This lead/appliance must only be wired by competent persons



WARNING: THIS APPLIANCE MUST BE EARTHED

IMPORTANT: The wires in this lead are coloured in accordance with the following code:

Green/ Yellow:	Earth
Blue:	Neutral
Brown:	Live (Phase)



As the colours of the wires in main leads may not correspond with the coloured marking identified in your plug/appliance, proceed as follows:

The wire which is coloured Green & Yellow must be connected to the Earth terminal marked with either the letter E, the earth symbol  or coloured Green/Green & Yellow.

The wire which is coloured Blue must be connected to the terminal which is marked with the letter N or coloured Blue or Black.

The wire which is coloured Brown must be connected to the terminal marked with the letter L or P or coloured Brown or Red.

If in doubt, consult the instructions provided with the equipment or contact the supplier.

This cable/appliance should be protected by a suitably rated and approved HBC mains fuse: refer to the rating information on the equipment and/or user instructions for details. As a guide, a cable of 0.75mm² should be protected by a 3A or 5A fuse. Larger conductors would normally require 13A types, depending on the connection method used.

Any exposed wiring from a cable, plug or connection that is engaged in a live socket is extremely hazardous. If a cable or plug is deemed hazardous, turn off the mains power and remove the cable, any fuses and fuse assemblies. All hazardous wiring must be immediately destroyed and replaced in accordance to the above standard.

GETTING STARTED

This chapter describes the GDS-2000A in a nutshell, including its main features and front / rear panel introduction. After going through the overview, follow the Set Up section to properly set up the oscilloscope for first time use. The Set Up section also includes a starter on how to use this manual effectively.



GDS-2000A Series Overview	11
Series lineup	11
Main Features	12
Accessories.....	13
Package Contents	15
Appearance	16
GDS-2074A/2104A/2204A/2304A Front Panel.....	16
GDS-2072A/2102A/2202A/2302A Front Panel.....	17
Rear Panel	24
Display.....	26
Set Up.....	29
Tilt Stand.....	29
Module Installation.....	30
Software Installation.....	31
Power Up	32
First Time Use.....	33
How to Use This Manual.....	35

GDS-2000A Series Overview

Series lineup

The GDS-2000A series consists of 8 models, divided into 2-channel and 4-channel versions.

Model name	Frequency bandwidth	Input channels	Real-time Sampling Rate
GDS-2072A	70MHz	2	2GSa/s
GDS-2102A	100MHz	2	2GSa/s
GDS-2202A	200MHz	2	2GSa/s
GDS-2302A	300MHz	2	2GSa/s
GDS-2074A	70MHz	4	2GSa/s
GDS-2104A	100MHz	4	2GSa/s
GDS-2204A	200MHz	4	2GSa/s
GDS-2304A	300MHz	4	2GSa/s

Main Features

- Features
- 8 inch TFT SVGA display.
 - MSO and DSO models available from 70MHz to 300MHz.
 - All models feature a real-time sampling rate of 2GSa/s and an equivalent time sampling rate of 100GSa/s.
 - Deep memory: 2M points record length.
 - Waveform capture rate of 80,000 waveforms per second.
 - Vertical sensitivity: 1mV/div~10V/div.
 - Logic Analyzer module (optional): Adds 8 or 16 channel digital inputs and serial bus (I2C, SPI, UART) and parallel bus triggering.
 - DDS Function Generator module (optional).
 - Segmented Memory: Optimizes the acquisition memory to selectively capture only the important signal details. Up to 2048 successive waveform segments can be captured with a time-tag resolution of 8ns. Segmented memory can be used for both analog and digital channels.
 - Enhanced Search: Allows the scope to search for a number of different signal events.
 - On-screen Help.
 - 64 MB internal flash disk.
-

- Interface
- USB host port: front and rear panel, for storage devices.
 - USB device port: rear panel, for remote control or printing.
 - Demo output
 - GPIB (optional)
 - RS232 port.
 - Calibration output
 - SVGA output and Ethernet port (optional)

Accessories

Standard Accessories	Part number	Description
	82DS-2304AM01	Quick Start Guide
	N/A region dependent	Power cord
	GTP-070A-4, for GDS-2072A/GDS-2074A	Passive probe; 70 MHz
	GTP-150A-2, for GDS-2102A/GDS-2104A	Passive probe; 150 MHz
	GTP-250A-2 for, GDS-2202A/GDS-2204A	Passive probe; 250 MHz
	GTP-350A-2 for, GDS-2302A/GDS-2304A	Passive probe; 350 MHz
Options	Option Number	Description
	DS2-LAN	Ethernet & SVGA output
	DS2-GPIB	GPIB Interface
	DS2-FGN	DDS Function Generator
	DS2-8LA	8-Channel Logic Analyzer card (GLA-08)with 8-Channel Logic Analyzer Probe (GTL-08LA)

DS2-16LA 16-Channel Logic Analyzer card (GLA-16)with 16-Channel Logic Analyzer Probe (GTL-16A)

Optional Accessories	Part number	Description
	GTC-001	Instrument cart, 470(W)x430(D)mm (U.S. type input socket)
	GTC-002	Instrument cart, 330(W)x430(D)mm (U.S. type input socket)
	GTL-110	test lead, BNC to BNC heads
	GTL-232	RS-232C cable, 9-pin Female to 9-pin female, Null modem for computer
	GTL-242	USB cable, USB2.0A-B type cable 4P
	GTL-08LA	8-Channel Logic Analyzer Testing Probe
	GTL-16LA	16-Channel Logic Analyzer Testing Probe
	GLA-08	8-Channel Logic Analyzer Card
	GLA-16	16-Channel Logic Analyzer Card
	GTP-070A-4	Passive probe; 70 MHz
	GTP-150A-2	Passive probe; 150 MHz
	GTP-250A-2	Passive probe; 250 MHz
	GTP-350A-2	Passive probe; 350 MHz

Drivers	
USB driver	LabVIEW driver

Package Contents

Check the contents before using the GDS-2000A.

Opening the Box

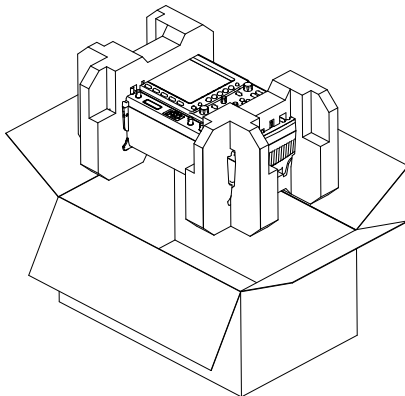

Contents

- Main unit
- Probe set
 - GTP-070A-4 for GDS-2072A / GDS-2074A
 - GTP-150A-2 for GDS-2102A / GDS-2104A
 - GTP-250A-2 for GDS-2202A / GDS-2204A
 - GTP-350A-2 for GDS-2302A / GDS-2304A
- Power cord
- Certificate of Traceable Calibration
- User Manual CD
- Quick Start Guide



The programming manual and USB driver are downloadable from the GW Instek website. Visit www.gwinstek.com, in the oscilloscope section.

Appearance

GDS-2074A/2104A/2204A/2304A Front Panel

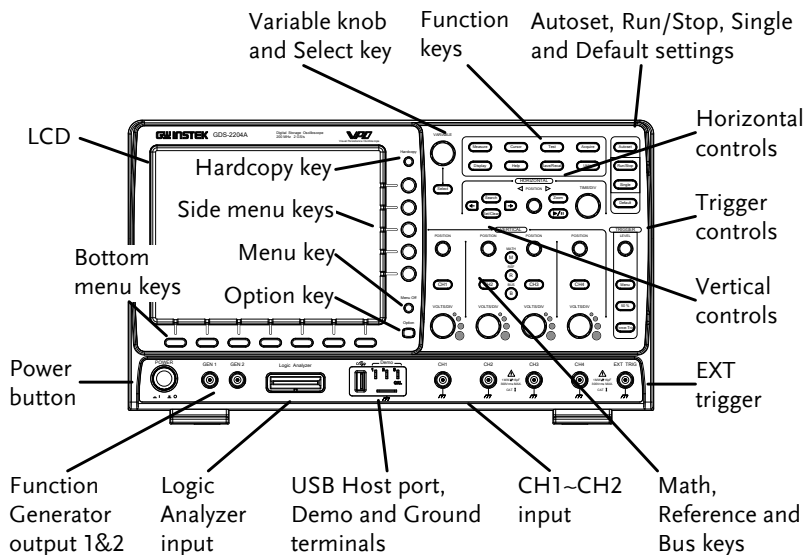

GDS-2072A/2102A/2202A/2302A Front Panel

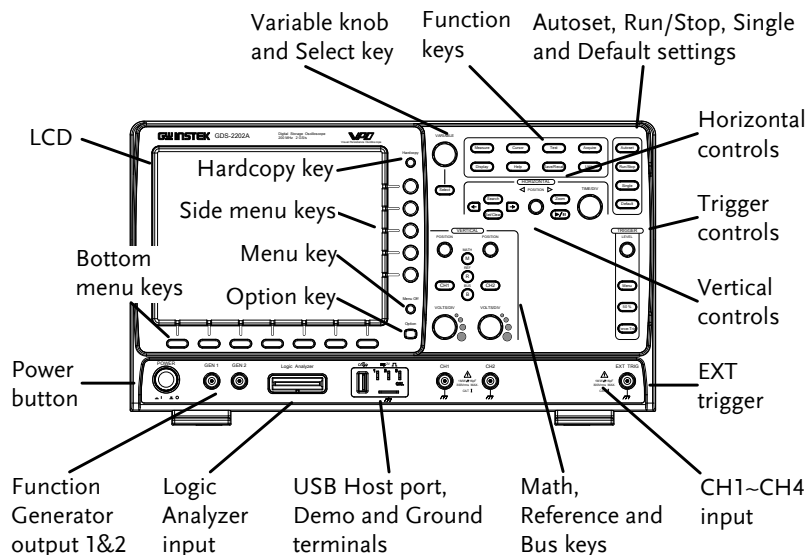

LCD Display 8" SVGA TFT color LCD. 800 x 600 resolution, wide angle view display.

Menu Off Key  Menu Off Use the Menu Off key to hide the onscreen menu system.

Option Key  Option The Option key is used to access any installed options, such the Logic Analyzer option.

Menu Keys

The Side menu and Bottom menu keys are used to make selections from the soft-menus on the LCD user interface.

To choose menu items, use the 7 Bottom menu keys located on the bottom of the display panel.

To select a variable or option from a menu, use the Side menu keys on the side of the panel. See page 35 for details.

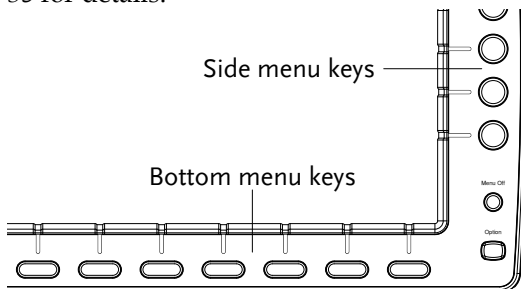

Hardcopy Key

Hardcopy



The Hardcopy key is a quick-save or quick-print key, depending on its configuration. For more information see pages 220(save) or 219(print).

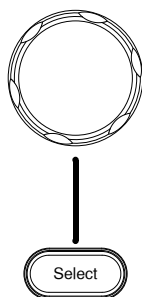

Variable Knob and Select Key

VARIABLE



The Variable knob is used to increase/decrease values or to move between parameters.

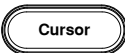
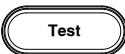
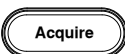
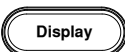

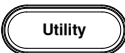
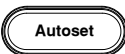
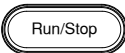
The Select key is used to make selections.

Function Keys	The Function keys are used to enter and configure different functions on the GDS-2000A.	
Measure		Configures and runs automatic measurements.
Cursor		Configures and runs cursor measurements.
Test		Configures and runs GW Instek applications.
Acquire		Configures the acquisition mode, including Segmented Memory acquisition.
Display		Configures the display settings.
Help		Shows the Help menu.
Save/Recall		Used to save and recall waveforms, images, panel settings.
Utility		Configures the Hardcopy key, display time, language, calibration and Demo outputs. It also accesses the file utilities menu.
Autoset		Press the Autoset key to automatically set the trigger, horizontal scale and vertical scale.
Run/Stop Key		Press to Freeze (Stop) or continue (Run) signal acquisition (page 68). The run stop key is also used to run or stop Segmented Memory acquisition (page 114).

Single  Sets the acquisition mode to single triggering mode.

Default Setup  Resets the oscilloscope to the default settings.

Horizontal Controls The horizontal controls are used to change the position of the cursor, set the time base settings, zoom into the waveforms and search for events*.

Horizontal Position  POSITION  The Position knob is used to position the waveforms horizontally on the display screen.



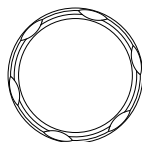

TIME/DIV  TIME/DIV The Time/Div knob is used to change the horizontal scale.





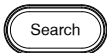

Zoom  Press Zoom in combination with the horizontal Position knob.

Play/Pause  The Play/Pause key allows you to view each search event in succession – to effectively “play” through each search event. It is also used to play through a waveform in zoom mode.

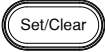
Search  The Search key accesses the search function menu to set the search type, source and threshold.

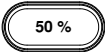
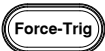
Search Arrows  Use the arrow keys to navigate the search events.

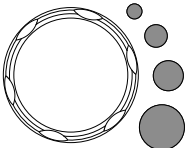
Set/Clear		Use the Set/Clear key to set or clear points of interest when using the search function.
Trigger Controls	The trigger controls are used to control the trigger level and options.	
Level Knob	<p>LEVEL</p> 	Used to set the trigger level.
Trigger Menu Key		Used to bring up the trigger menu.
50% Key		Sets the trigger level to the half way point (50%).
Force - Trig		Press to force an immediate trigger of the waveform.
Vertical POSITION	<p>POSITION</p> 	Sets the vertical position of the waveform.
Channel Menu Key		Press the CH1~4 key to set and configure the channel.
VOLTS/DIV Knob	<p>VOLTS/DIV</p> 	Sets the vertical scale of the channel.

External Trigger Input

EXT TRIG

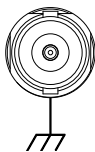

Accepts external trigger signals (page 144).

Input impedance: $1M\Omega$
Voltage input: $\pm 15V$ (peak), EXT trigger capacitance: $16pF$.

Math Key



Use the math key to set and configure math functions.

Reference Key



Press the Reference key to set or remove reference waveforms.

BUS Key



The Bus key is used for parallel and serial bus (UART, I²C and SPI) configuration. Serial bus and parallel bus functionality is included with the Logic Analyzer options (DS2-8LA/DS2-16LA).

Channel Inputs

CH1

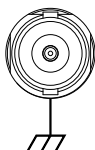

Accepts input signals.
Input impedance: $1M\Omega$.

USB Host Port

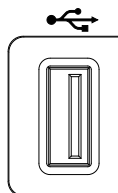

TypeA, 1.1/2.0 compatible. Used for data transfer.

Ground Terminal

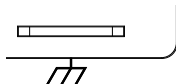

Accepts the DUT ground lead for common ground.

Demo and Probe Compensation Outputs

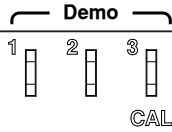

The Demo outputs are multifunction outputs that can be configured for probe compensation, as a trigger output or as a basic waveform generator for demonstration purposes. (FM signal, UART, I²C, SPI).

By default, the 3 Demo outputs are configured as:

- 1: Trigger output
- 2: FM waveform
- 3: Probe Compensation signal

CAL (Demo 3) outputs a 2Vp-p, square wave signal for probe compensation.

Please see page 171 for details.

Logic Analyzer Port

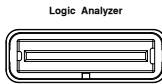

The Logic Analyzer port is used to connect to a Logic Analyzer probe. This port only functions if the optional logic analyzer module is installed.

Function Generator Output

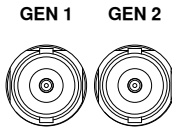

The function generator outputs are used with an optional function generator module.

Power Switch

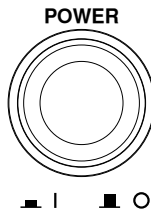

Used to turn the power on/off.

- | : ON
- ○ : OFF

Rear Panel

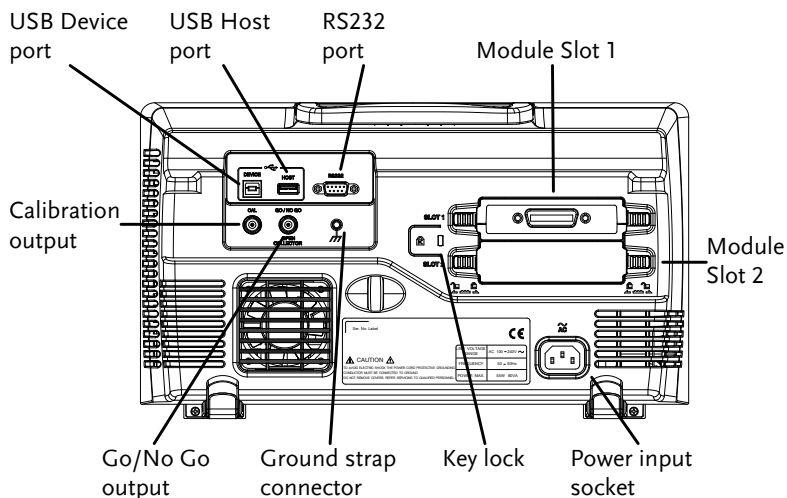

Calibration Output



Outputs the signal for vertical scale accuracy calibration (page 243).

USB Device Port

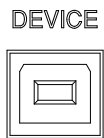

The USB Device port is used for remote control.

USB Host Port



The USB Host port is used to data transfer.

Note: Only one rear panel USB port can be used at a time. Inserting a USB flash drive into the USB Host Port will disable the USB Device Port, and vice versa.

RS232 Port



Used for RS-232-based remote control.

Module Slots

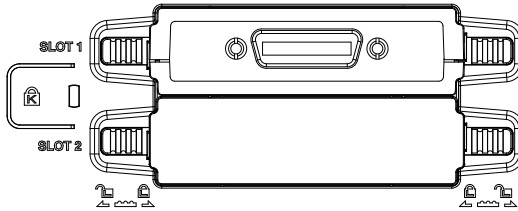

The module slots are used to install the optional modules:

DS2-LAN: Ethernet and SVGA

DS2-GPIB: GPIB

GLA-08: 8 channel logic analyzer

GLA-16: 16 channel logic analyzer

Power Input Socket

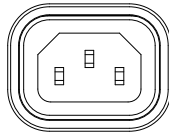

Power cord socket accepts AC mains, 100 ~ 240V, 50/60Hz.

For power up sequence, see page 32.

Security Slot



Kensington security slot compatible.

Ground Strap Connector



For use with a grounding strap.

Go-No Go Output

GO / NO GO

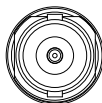







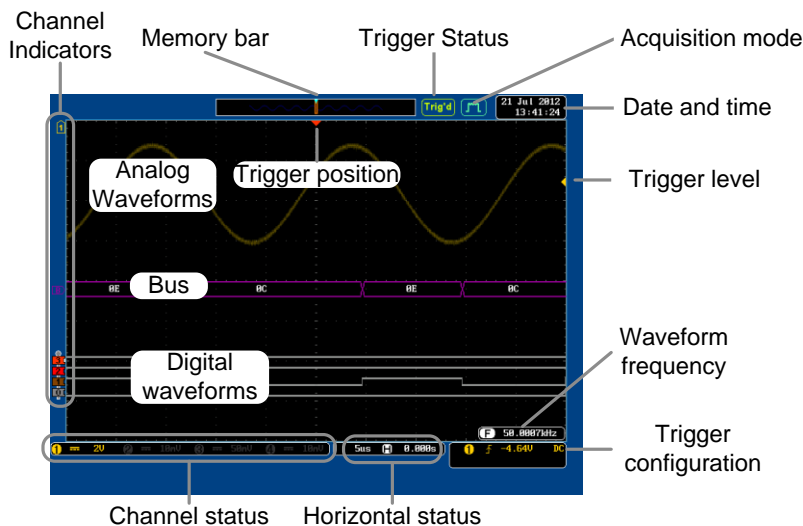



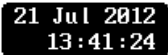

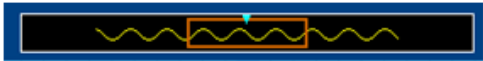
OPEN COLLECTOR

Outputs Go-No Go test results (page 177) as a 500us pulse signal.

Display



Analog Waveforms	Shows the analog input signal waveforms. Channel 1: Yellow Channel 2: Blue Channel 3: Pink Channel 4: Green
Bus Waveforms	Shows the bus waveforms for either parallel or serial buses. The values are displayed in hex or binary.
Digital Waveforms	Shows the digital channel waveforms. There can be up to 16 digital channels.
Channel Indicators	The channel indicators show the zero volt level of the signal waveform for each activated channel. Any active channel is shown with a solid color. <div style="margin-left: 20px;"> 3 Analog channel indicator B Bus indicator(B) 3 Digital channel indicator 1 Reference waveform indicator </div>

		Math indicator
Trigger Position		Shows the position of the trigger.
Horizontal Status		Shows the horizontal scale and position.
Date and Time		Current date and time (page 170).
Trigger Level		Shows the trigger level on the graticule.
Memory Bar		The ratio and the position of the displayed waveform compared with the internal memory (page 130).
Trigger Status		Triggered.
		Pre-trigger.
		Not triggered, display not updated.
		Trigger stopped. Also appears in Run/Stop (page 68).
		Roll mode.
		Auto trigger mode.
		For trigger details, see page 144.
Acquisition Mode		Normal mode
		Peak detect mode
		Average mode
		For acquisition details, see page 103.
Signal Frequency		Shows the trigger source frequency.

F <2Hz Indicates the frequency is less than 2Hz (lower frequency limit).

Trigger Configuration **1** \int -4.64V **DC** Trigger source, slope, voltage, coupling.

Horizontal Status **5us**  **0.000s** Horizontal scale, horizontal position.

For trigger details, see page 144.

Channel Status **1** **=** **2V** Channel 1, DC coupling, 2V/Div.

For channel details, see page 137.

Set Up

Tilt Stand

Tilt

To tilt, pull the legs forward, as shown below.

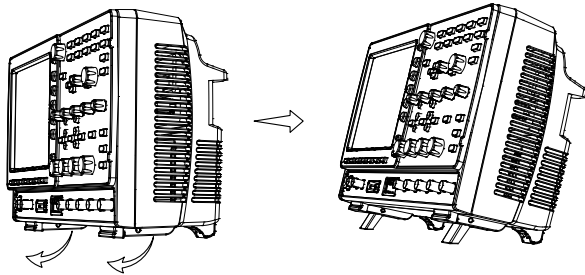

Stand

To stand the scope upright, push the legs back under the casing as shown below.

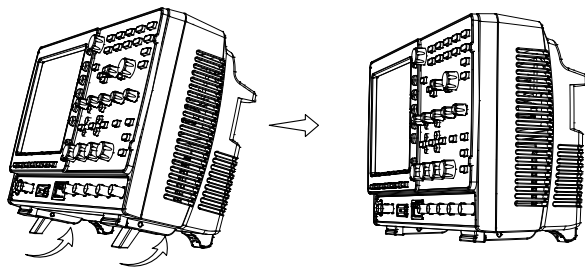

Module Installation

Background The GDS-2000A has a number of optional modules that can be installed into the module slots on the rear panel. These modules must be installed before power up.

 **Note** The modules are not hot-swappable. Please ensure the power is off before connecting or disconnecting any of the modules from the rear panel.

- Steps**
1. Make sure the power is turned off before installing any of the optional modules.
 2. Slide the tabs holding the module cover to the unlock position and then remove

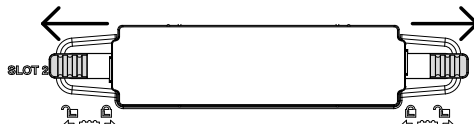

3. Install the optional module. Be sure to make sure that the grooves on the module line-up to the slots in the module bay.

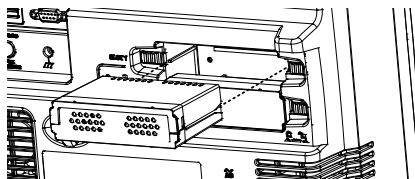

4. Slide the tabs back into the lock position.

Software Installation

Background The GDS-2000A has optional software packages to expand the functionality of the standard GDS-2000A. An activation key is required to activate any optional software. A different activation key is required for each optional software package.

For the latest files and information regarding the optional software packages, see the GW Instek website: www.gwinstek.com or contact your nearest distributor.

Steps 1. Install any hardware modules if needed. See page 30 for installation details.

Panel Operation 2. Insert the USB serial key for the desired option into the front panel USB A port.

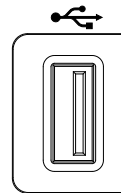

3. Press the *Utility* key then the *File Utilities* soft-key.

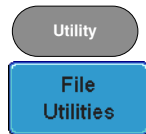

4. Navigate to the desired file in the USB file path.

VARIABLE

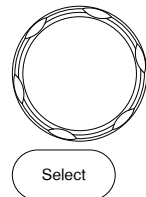

When the desired installation file has been found, press the *Select* key to start the installation.

5. The installation will complete in a few seconds. When finished a pop-up message will appear asking you to restart the GDS-2000A.
6. Restart the GDS-2000A.

Power Up

Requirements The GDS-2000A accepts line voltages of 100 ~ 240V at 50 or 60Hz.

Step 1. Connect the power cord to the rear panel socket.

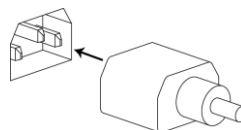

2. Press the POWER key. The display becomes active in ~ 30 seconds.

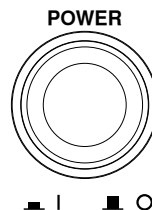

- | : ON
- ○ : OFF

 **Note**

The GDS-2000A recovers the state right before the power is turned OFF. The default settings can be recovered by pressing the Default key on the front panel. For details, see page 202.

First Time Use

Background	This section describes how to connect a signal, adjust the scale, and compensate the probe. Before operating the GDS-2000A in a new environment, run these steps to make sure the instrument performs at its full potential.	
1. Power On	Follow the procedures on the previous page.	
2. Set the Date and Time	Set the date and time.	Page 170
3. Reset System	Reset the system by recalling the factory settings. Press the <i>Default</i> key on the front panel. For details, see page 202.	
4. Install Optional modules	There are a number of optional hardware modules that can be installed, such as the optional function generator.	Page 30
5. Install Optional Software	Optional software packages may also need to be installed.	Page 31
6. Connect Probe	Connect the probe to the Channel 1 input and to the CAL signal output (Demo 3 output). This output provides a 2Vp-p, 1kHz square wave for signal compensation by default. Set the probe attenuation to x10 if the probe has adjustable attenuation.	

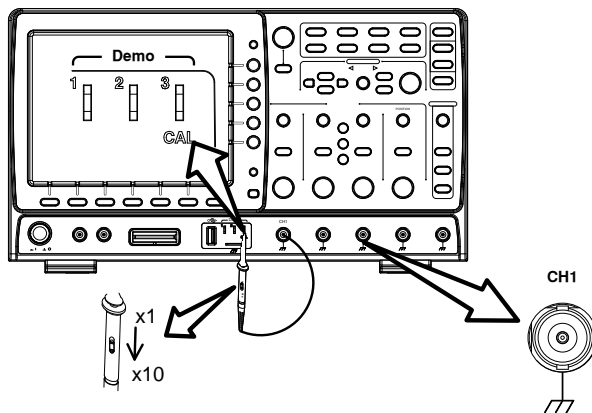

6. Capture Signal (Autoset)

Press the *Autoset* key. A square waveform appears on the center of the screen. For Autoset details, see page 66.

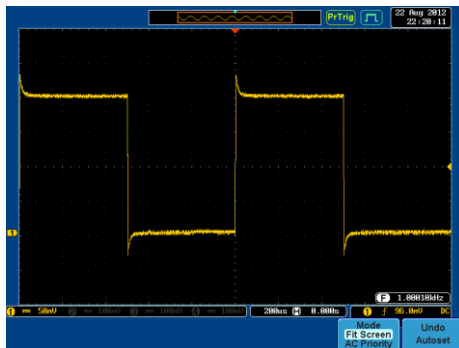

7. Select Vector Waveform

Press the *Display* key, and set the display to *Vector* on the bottom menu.

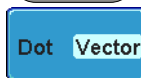
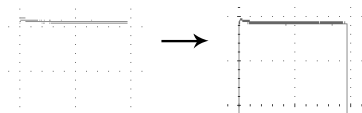
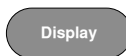

8. Compensate Probe

Turn the adjustment point on the probe to make the square waveform edge flat.

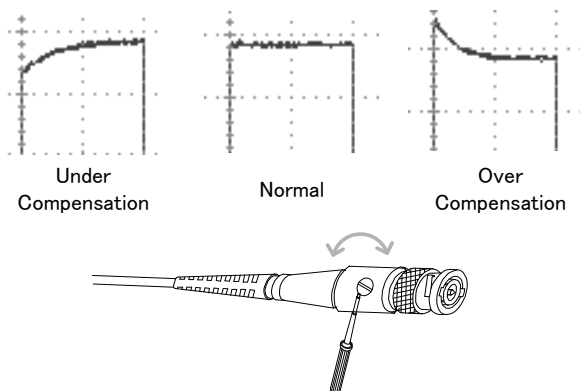

9. Start Operation Continue with the other operations.

Measurement: page 64 Configuration: page 101

Save/Recall: page 185 File Utilities: page 211

Apps.: page 174 Hardcopy key: page 218

Remote Control: page 222 Maintenance: page 241

How to Use This Manual

Background This section describes the conventions used in this manual to operate the GDS-2000A.

Throughout the manual any reference to pressing a menu key refers to the keys directly below or beside any menu icons or parameters.

When the user manual says to “toggle” a value or parameter, press the corresponding menu item. Pressing the item will toggle the value or parameter.

Active parameters are highlighted for each menu item. For example in the example below, Coupling is currently set to DC.

If a menu item can be toggled from one value or parameter to another, the available options will be visible, with the current option highlighted. In the example below the slope can be toggled from a rising slope to a falling slope or either slope.

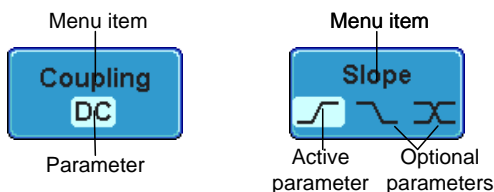

Selecting a Menu Item, Parameter or Variable

When the user manual says to “select” a value from one of the side menu parameters, first press the corresponding menu key and use the Variable knob to either scroll through a parameter list or to increase or decrease a variable.

Example 1

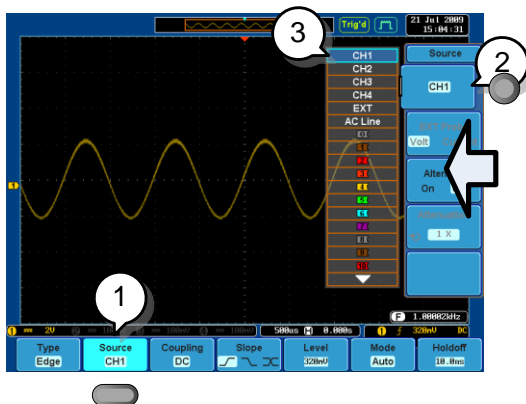

1. Press a bottom menu key to access the side menu.

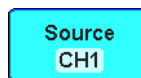

2. Press a side menu key to either set a parameter or to access a sub menu.



3. If accessing a sub menu or setting a variable parameter, use the Variable knob to scroll through menu items or variables. Use the Select key to confirm and exit.

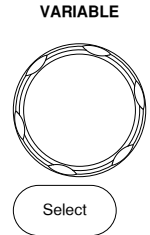

4. Press the same bottom menu key again to reduce the side menu.

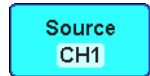

Example 2

For some variables, a circular arrow icon indicates that the variable for that menu key can be edited with the Variable knob.

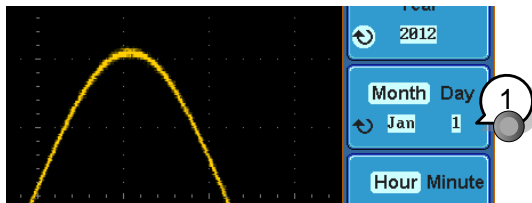

1. Press the desired menu key to select it. The circular arrow will become highlighted.

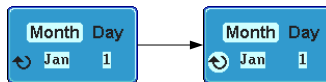

2. Use the Variable knob to edit the value.

Toggle a Menu Parameter

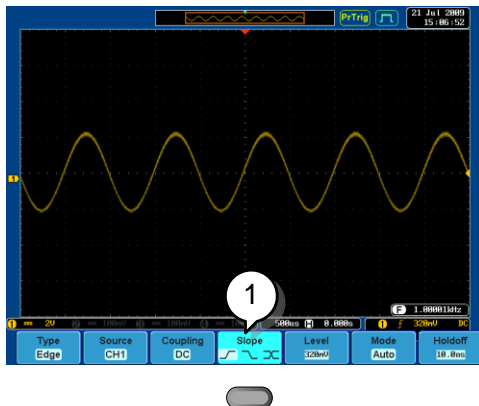

1. Press the bottom menu key to toggle the parameter.

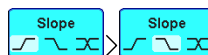

Reduce Side Menu

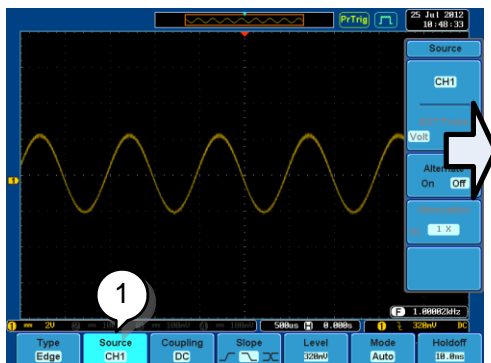

1. To reduce the side menu, press the corresponding bottom menu that brought up the side menu.

For example: Press the *Source* soft-key to reduce the *Source* menu.

Reduce Lower Menu

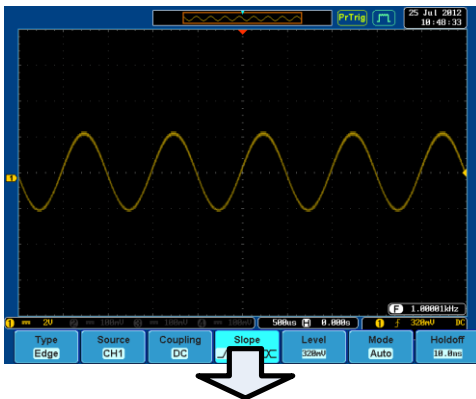

1. Press the relevant function key again to reduce the bottom menu. For example: press the Trigger Menu key to reduce the trigger menu.

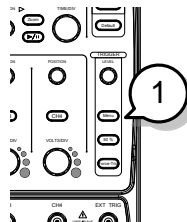

Remove All Menus

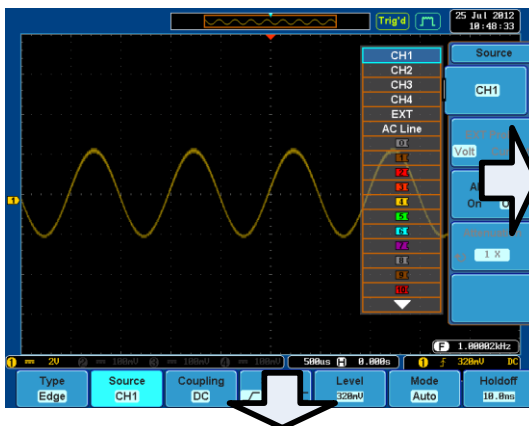

1. Press the *Menu Off* key to reduce the side menu, press again to reduce the bottom menu.

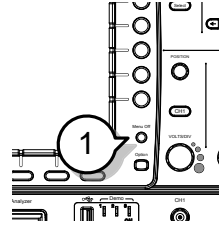

Remove On-Screen Messages

2. The *Menu Off* key can also be used to remove any on screen messages.

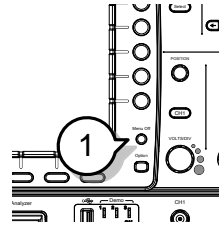

QUICK REFERENCE

This chapter describes the GDS-2000A menu tree, shortcuts to major operations, built-in Help access, and default factory settings. Use them as a handy reference to get a quick access to the functionality.

Menu Tree / Operation Shortcuts	43
Convention	43
Acquire Key	44
Acquire Key - Segments	44
Autoset Key	45
CH1 ~ 4 Key	45
Cursor Key	46
Display Key	46
Help Key	46
Math Key	47
Measure Key	48
Hardcopy Key	49
Run/Stop Key	49
REF Key	49
Save/Recall Key	50
Test Key	51
Test Key – Go-NoGo	51
Trigger Type Menu	52
Trigger Edge Menu	52
Trigger Delay Menu	53
Trigger Pulse Width Menu	53
Trigger Video Menu	53
Trigger Pulse Runt Menu	54
Trigger Rise & Fall Menu	54
Trigger Timeout Menu	54
Utility Key	55
Utility Key – I/O	56
Utility Key – File Utilities	56

Utility Key – Wave Generator - Demo Outputs	57
Search - Edge.....	57
Search – Pulse Width.....	58
Search - Runt	58
Search – Rise/Fall Time.....	59
Zoom Key.....	59
Option Key.....	60
Default Settings	61
Built-in Help	63

Menu Tree / Operation Shortcuts

Convention

For all menu trees, the bottom menu keys are shown as grey icons and side menu keys are shown in white. All menu tree operations are shown in order from top to bottom.

Below is an example of the menu tree operation for the trigger source menu and a comparison to the operation on the DSO screen.

Menu Tree

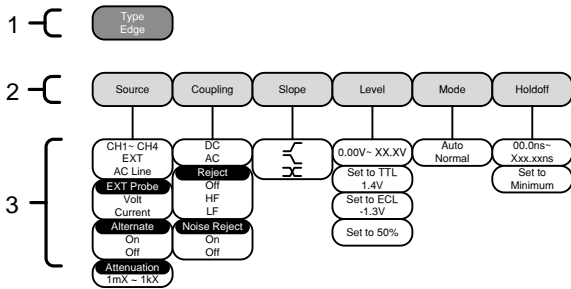

On Screen Menu

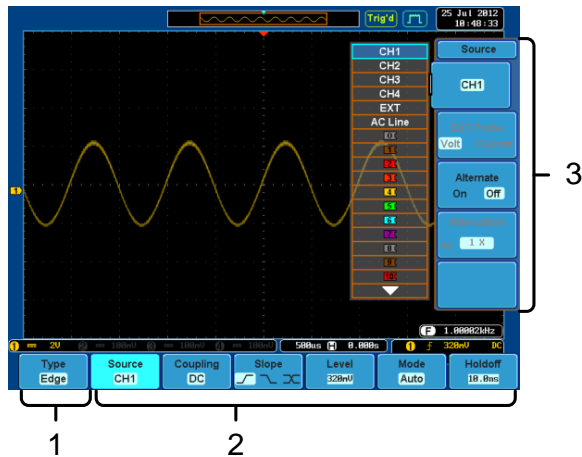

Acquire Key

Sets the acquisition mode.

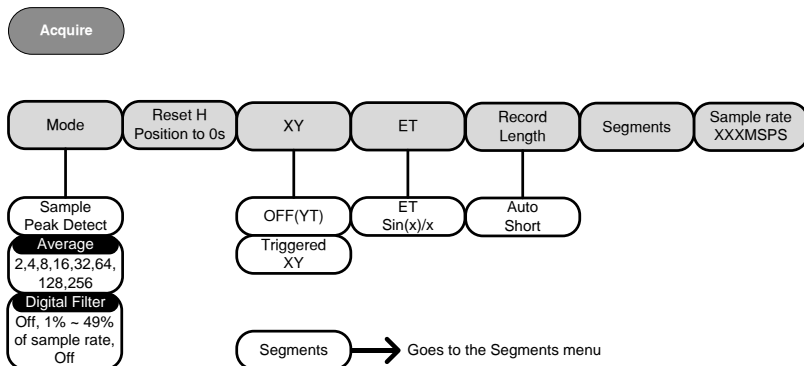

Acquire Key - Segments

Setup the Segmented Memory function.

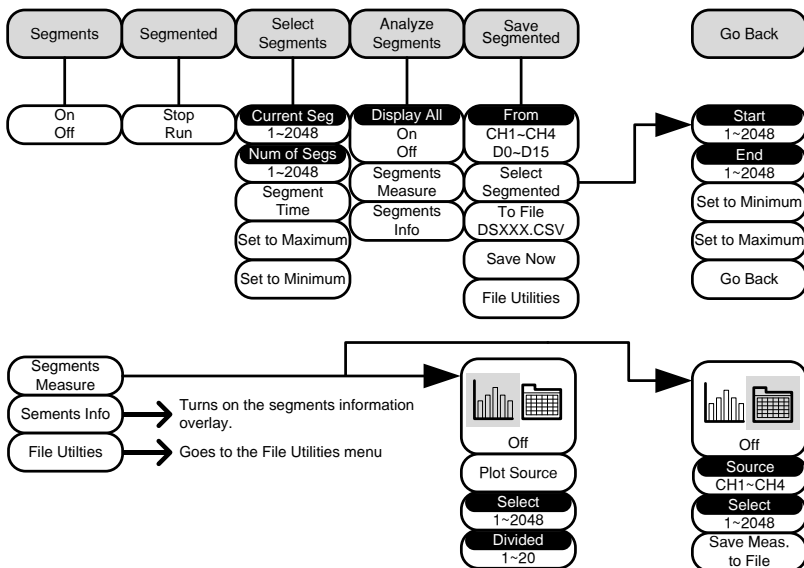

Autoset Key

Automatically finds the signal and sets the horizontal and vertical scale.

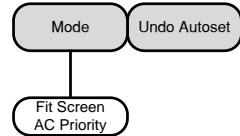

CH1 ~ 4 Key

Set the channel input parameters.

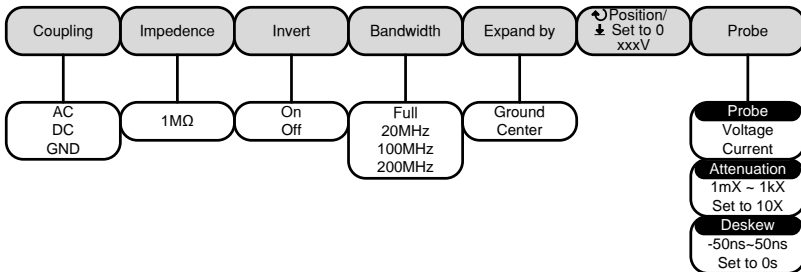
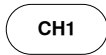

Cursor Key

Set cursor positions.

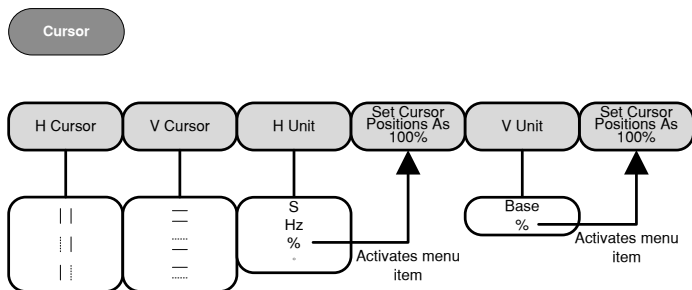

Display Key

Set the display properties.

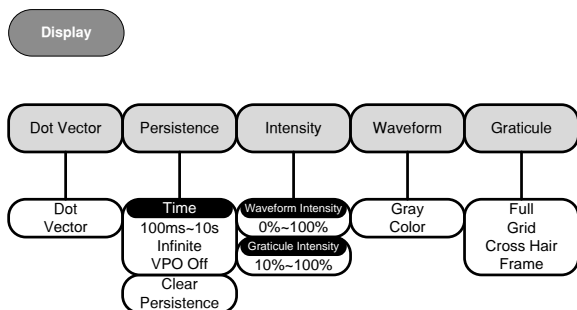

Help Key

Turn help mode On/Off.



Math Key

Standard math and FFT functions.

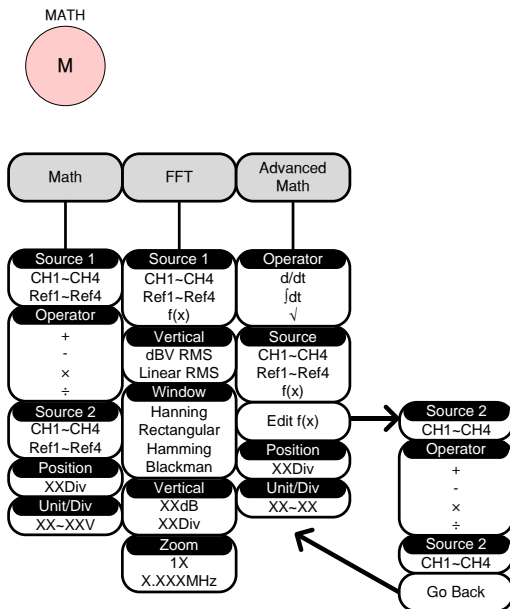

Measure Key

Display automatic measurements either individually or as voltage/current, time or delay measurement groups.

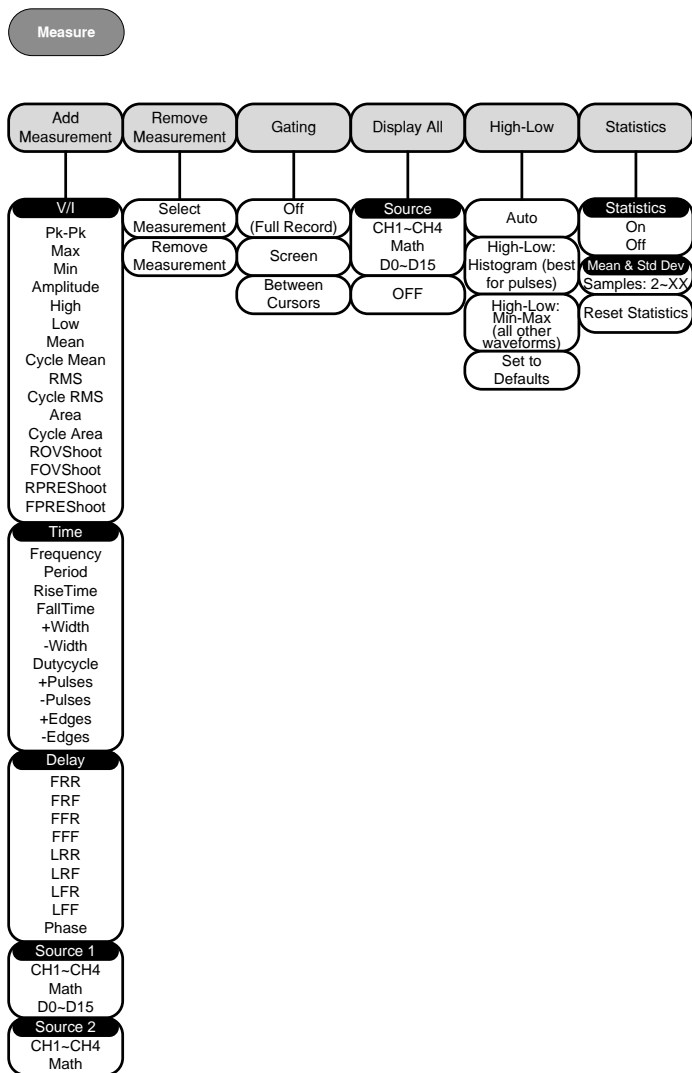

Hardcopy Key

Hardcopy



Print screen images or save a waveform, screen image or setup (depending on the assigned function).

Run/Stop Key

Run/Stop

Run/stop signal acquisition.

REF Key

REF

R

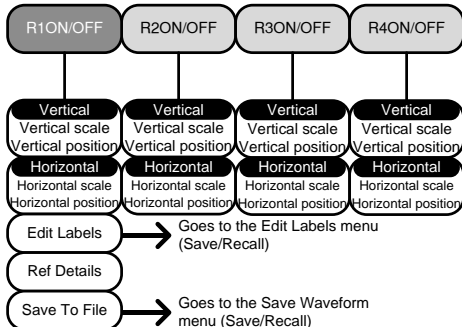

Save/Recall Key

Save and recall images, waveforms and panel setups. Edit labels for reference and setup files.

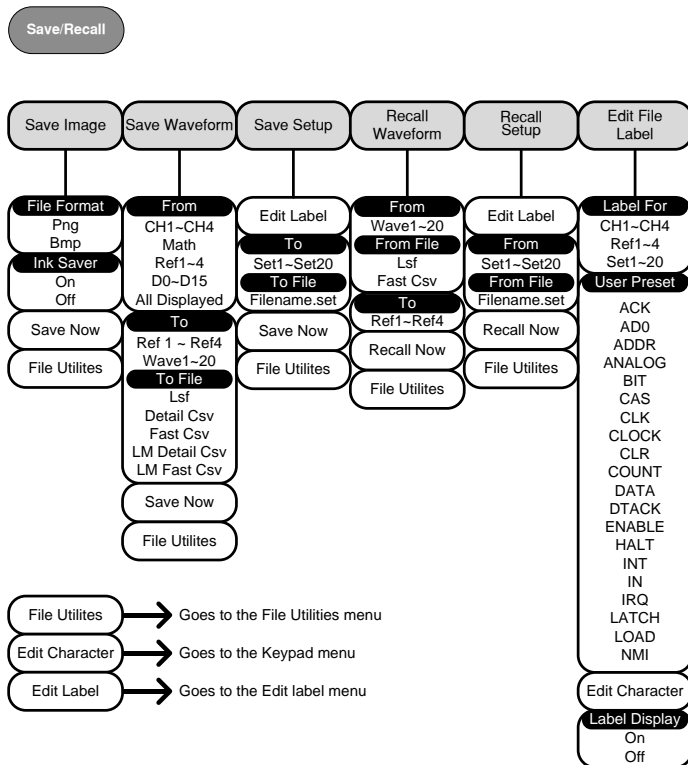

Test Key

Use the Go-NoGo application as well as other optional software.

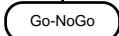

Test Key – Go-NoGo

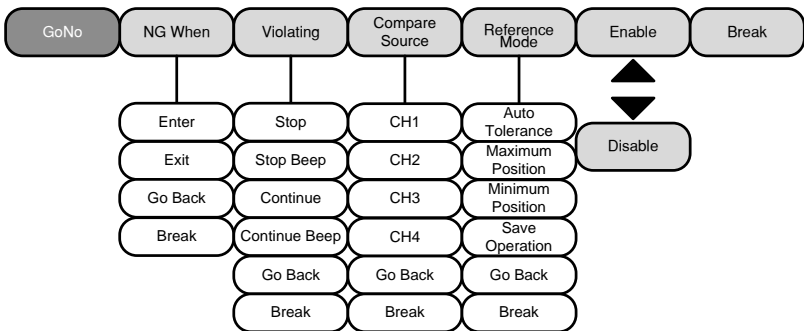

Trigger Type Menu

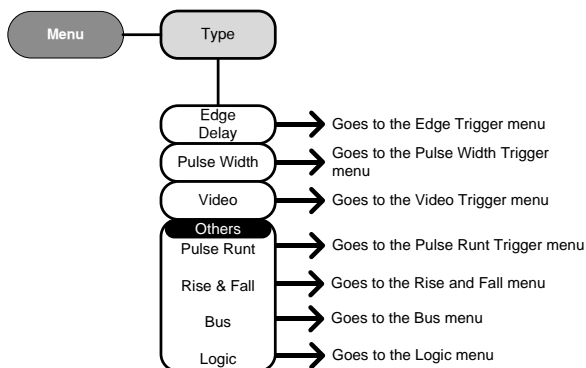

Trigger Edge Menu

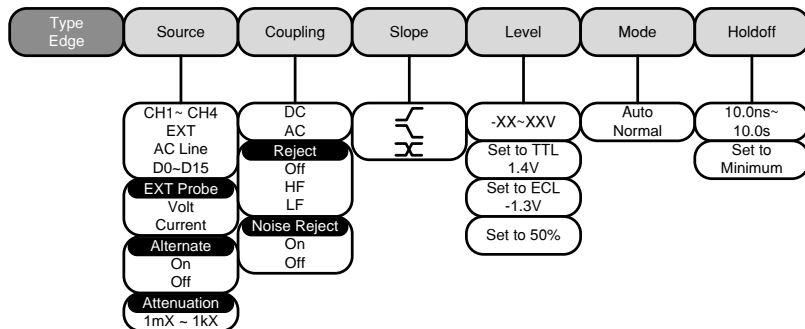

Trigger Delay Menu

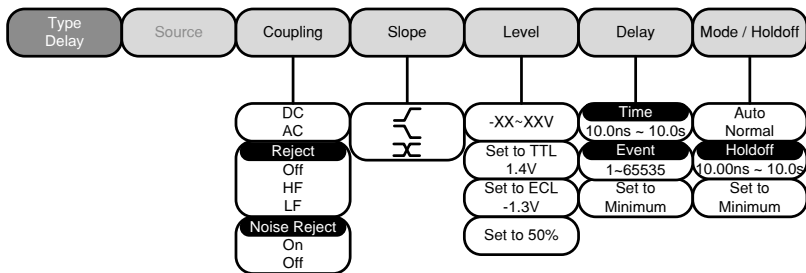

Trigger Pulse Width Menu

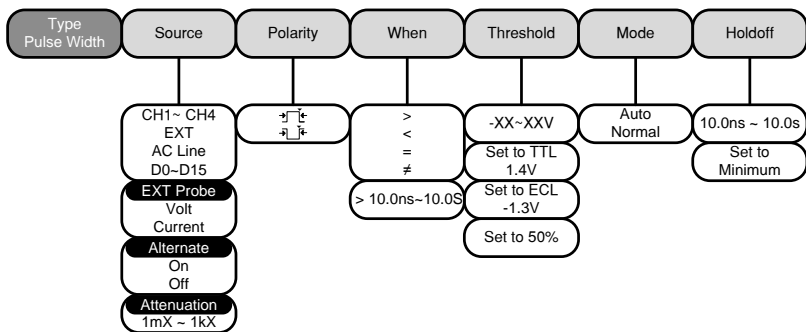

Trigger Video Menu

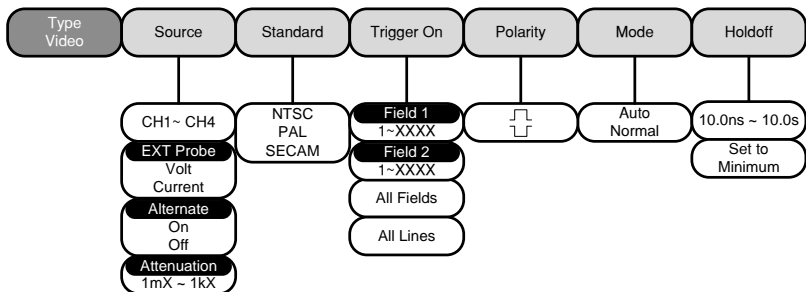

Trigger Pulse Runt Menu

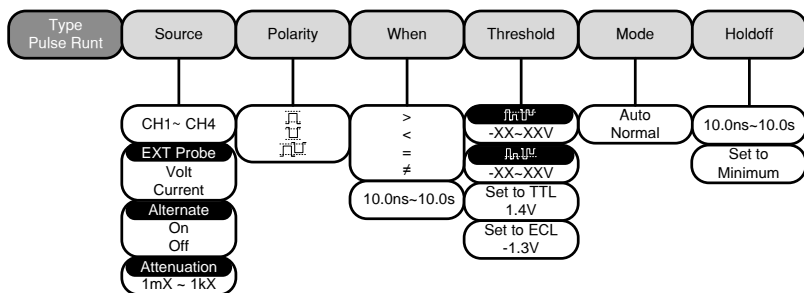

Trigger Rise & Fall Menu

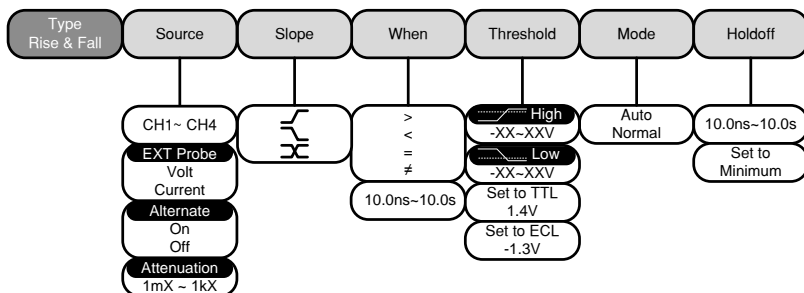

Trigger Timeout Menu

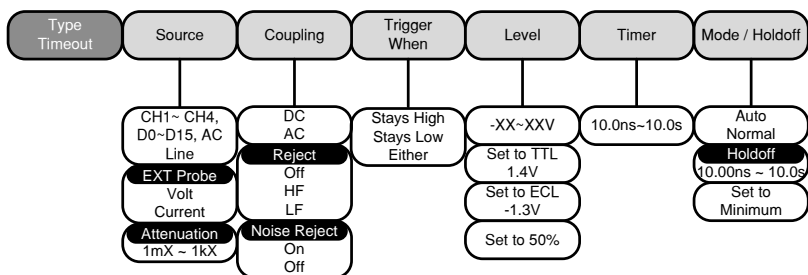

Utility Key

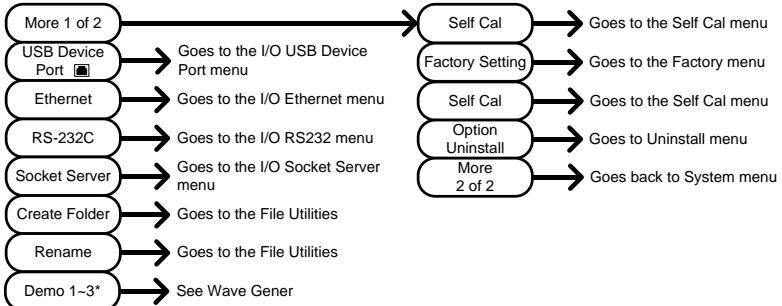
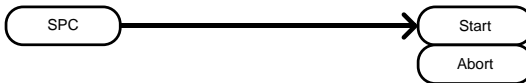
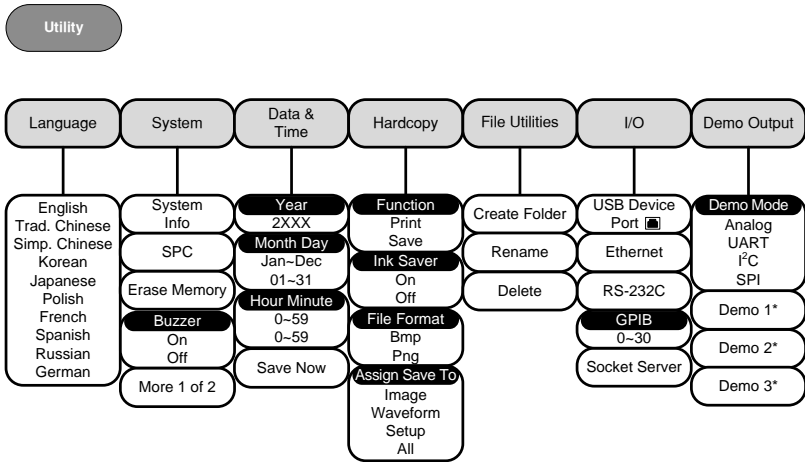

* Demo 1, Demo 2, Demo 3 outputs depend on the Demo Output settings.

Utility Key – I/O

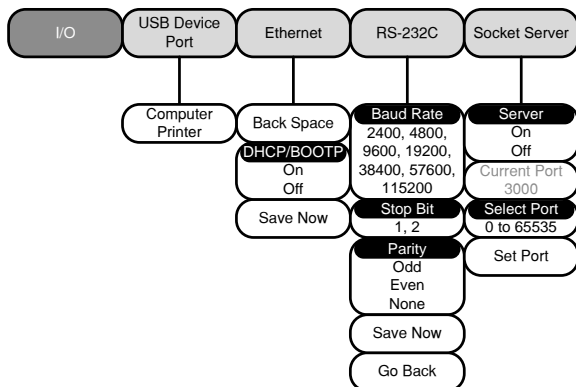

Utility Key – File Utilities

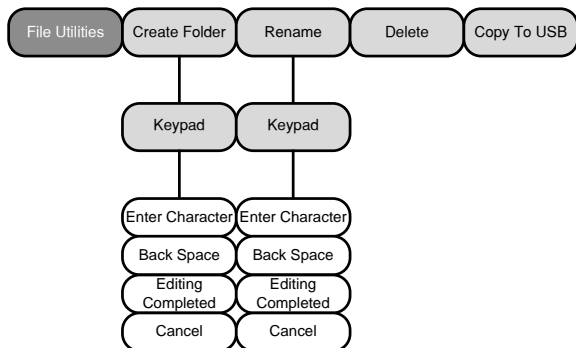

Utility Key – Wave Generator - Demo Outputs

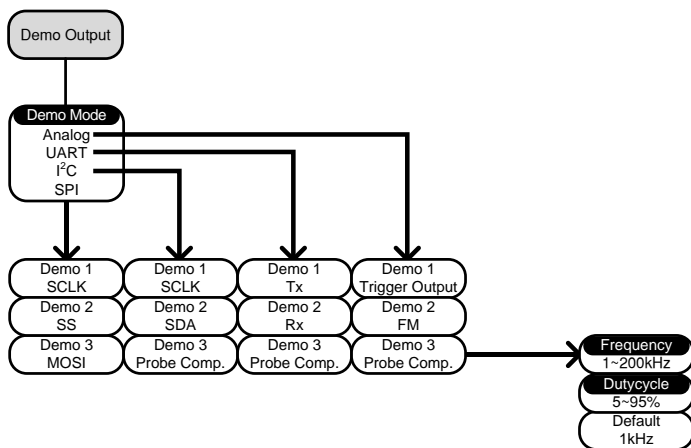

Search - Edge

Set the Search Function for edge events.

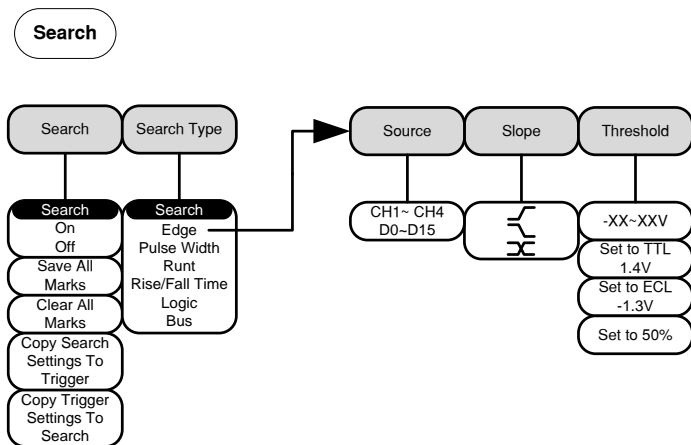

Search – Pulse Width

Set the Search Function for pulse width events.

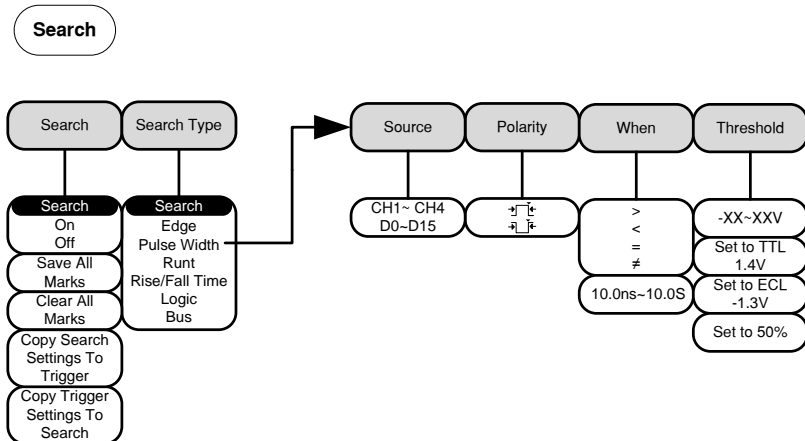

Search - Runt

Set the Search function for runt events.

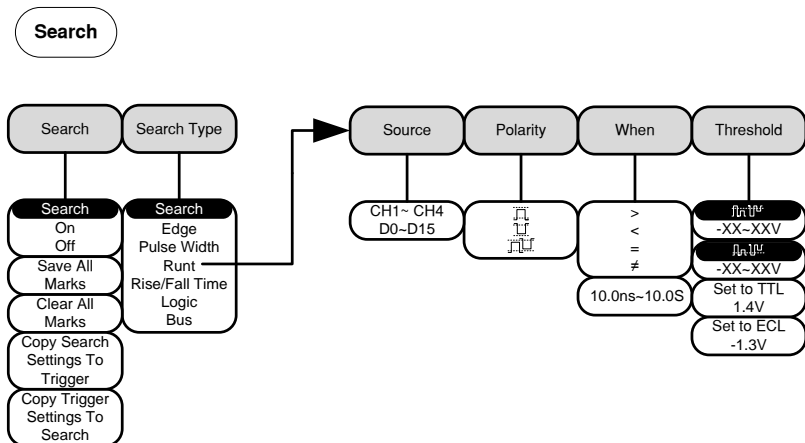

Search – Rise/Fall Time

Set the Search function for rise and fall time events.

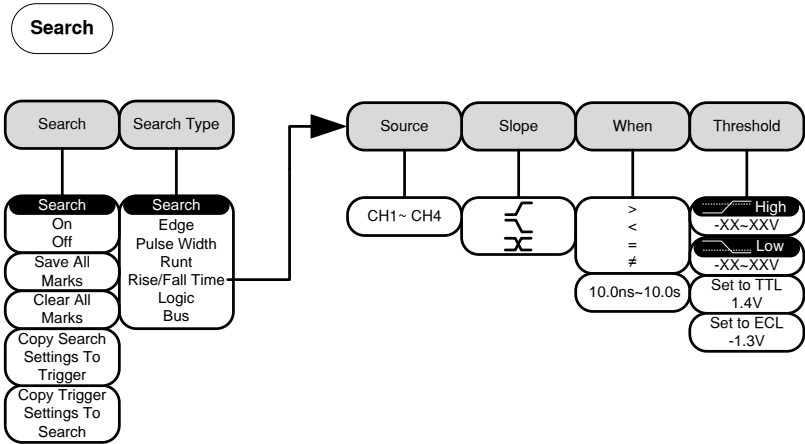

*The source bus is determined from the bus trigger settings.

Zoom Key

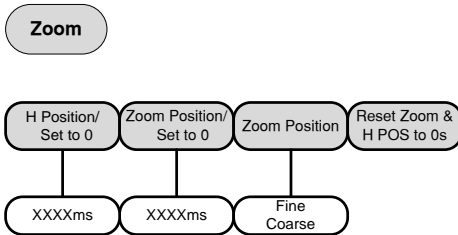

Option Key

Accesses the functions in the Option menu.

Option

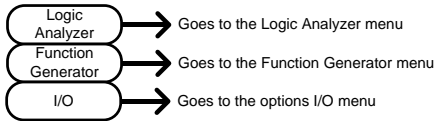
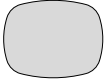

*Note: Any option that is not installed will be grayed-out.

Default Settings

The default factory installed settings can be recalled at any time by pressing the *Default* key.



Acquire	Mode: Sample Interpolation: Sin(x)/x Record Length: Auto	XY: OFF Sample rate: 2GSPS
Display	Mode: Vector Waveform intensity: 50% Waveform visuals: Gray	Persistence: 240ms Graticule intensity: 50% Graticule: full 
Channel	Scale: 100mV/Div Coupling: DC Invert: Off Expand: By ground Probe: voltage Deskew: 0s	CH1: On Impedance: 1MΩ Bandwidth: full Position: 0.00V Probe attenuation: 1x
Cursor	Horizontal cursor: Off	Vertical Cursor: Off
Measure	Source: CH1 Display: Off Statistics: Off	Gating: Screen High-Low: Auto Mean & Std Dev Samples: 2
Horizontal	Scale: 10us/Div	Position: 0.000s
Math	Source1: CH1 Source2: CH2 Unit/Div: 200mV	Operator: + Position: 0.00 Div Math Off
Test	App: Go-NoGo	
Trigger	Type: Edge	Source: CH1

	Coupling: DC	Alternate: Off
	Rejection: Off	Noise Rejection: Off
	Slope: Positive	Level: 0.00V
	Mode: Auto	Holdoff: 10.0ns
Utility	Hardcopy: Save	Ink Saver: Off
	Assign Save To: Image	File Format: Bmp
Search	Search: Off	
Segments	Segments: Off	

Built-in Help

The Help key accesses a context sensitive help menu. The help menu contains information on how to use the front panel keys.

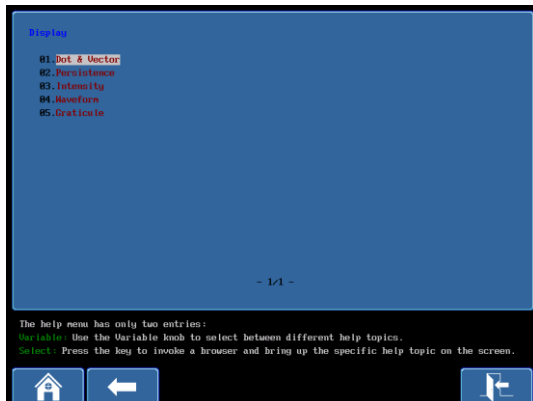

- Panel Operation
1. Press the *Help* key. The display changes to Help mode. 
 2. Use the *Variable* knob to scroll up and down through the Help contents. Press *Select* to view the help on the selected item.

Example: Help on the Display key



Home Key Press the *Home* key to return to the main help screen. 

Go Back Press the *Back* key to go to the previous menu page. 

Exit Press the *Help* key again or press the *Exit* key to exit the Help mode.  

M EASUREMENT

Basic Measurement	65
Channel Activation	65
Autoset	66
Run/Stop	68
Horizontal Position/Scale	69
Vertical Position/Scale	71
Automatic Measurement	72
Measurement Items	72
Add Measurement	76
Remove Measurement	78
Gated mode	79
Display All mode	80
High Low Function	81
Statistics	83
Cursor Measurement	85
Use Horizontal Cursors	85
Use Vertical Cursors	89
Math Operation	93
Overview	93
Addition/Subtraction/Multiplication/Division	94
FFT	96
Advanced Math	98
Edit F(x)	100

Basic Measurement

This section describes the basic operations required in capturing and viewing the input signal. For more detailed operations, see the following chapters.

- Cursor Measurement → from page 85
- Configuration → from page 101

Before operating the oscilloscope, please see the Getting Started chapter, page 10.

Channel Activation

Activate Channel To activate an input channel, press a *channel* key.

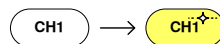

When activated, the channel key will light up. The corresponding channel menu will also appear.

Each channel is associated with the color shown beside the VOLTS/DIV dial: CH1: yellow, CH2: blue, CH3: pink and CH4: green.

When a channel is activated, it is shown above the bottom menu system.

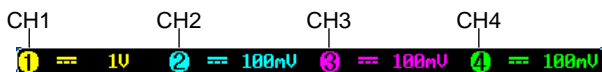

De-activate Channel

To de-activate a channel, press the corresponding *channel* key again. If the channel menu is not open, press the *channel* key twice (the first press shows the Channel menu).

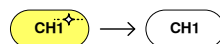

Default Setup To activate the default state, press *Default*. 

Autoset

Background The Autoset function automatically configures the panel settings to position the input signal to the best viewing condition. The GDS-2000A automatically configures the following parameters.

- Horizontal scale
- Vertical scale
- Trigger source channel

There are two operating modes for the Autoset function: Fit Screen Mode and AC Priority Mode.

Fit Screen Mode will fit the waveform to the best scale, including any DC components (offset). AC priority mode will scale the waveform to the screen by removing any DC component.

Panel Operation 1. Connect the input signal to the GDS-2000A and press the *Autoset* key. 

2. The waveform appears in the center of the display.

Before

After

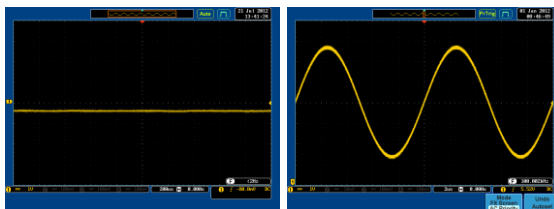

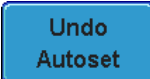
3. To undo Autoset, press *Undo Autoset* from the bottom menu. 

Change modes 1. Choose between *Fit Screen Mode* and *AC Priority Mode* from the bottom menu.



2. Press the *Autoset* key again to use Autoset in the new mode.

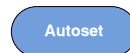

Fit Screen Mode

AC Priority

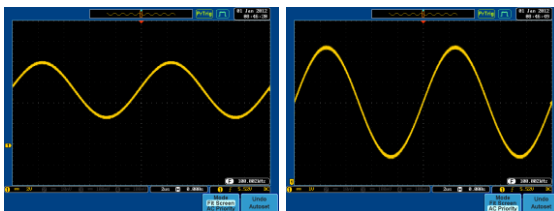

Limitation Autoset does not work in the following situations.

- Input signal frequency is less than 20Hz
- Input signal amplitude is less than 30mV



The Autoset key (page 66) does NOT automatically activate the channels to which input signals are connected.

Run/Stop

Background

By default, the waveform on the display is constantly updated (Run mode). Freezing the waveform by stopping signal acquisition (Stop mode) allows flexible observation and analysis. To enter Stop mode, two methods are available: pressing the Run/Stop key or using the Single Trigger mode.

Stop mode icon When in Stop mode, the Stop icon appears at the top of the display.



Triggered icon



Freeze Waveform by Run/Stop Key

Press the *Run/Stop* key once. The *Run/Stop* key turns red. The waveform and signal acquisition freezes.

Stop:

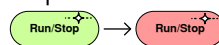

To unfreeze, press the *Run/Stop* key again. The *Run/Stop* key turns green again.

Run:

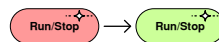

Freeze Waveform by Single Trigger Mode

Press the *Single* key to go into the Single Trigger mode. The *Single* key turns bright white.

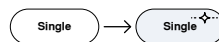

In the Single Trigger mode, the scope will be put into the pre-trigger mode until the scope encounters the next trigger point. After the scope has triggered, it will remain in Stop mode, until the *Single* key is pressed again or the *Run/Stop* key is pressed.

Waveform Operation The waveform can be moved or scaled in both Run and Stop mode, but in different manners. For details, see page 130 (Horizontal position/scale) and page 137 (Vertical position/scale).

Horizontal Position/Scale

For more detailed configuration, see page 130.

Set Horizontal Position The horizontal position knob moves the waveform left and right.



As the waveform moves, the display bar on the top of the display indicates the portion of the waveform currently shown on the display and the position of the horizontal marker on the waveform.

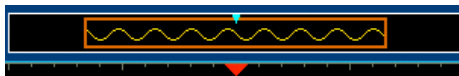

Position Indicator The horizontal position is shown at the bottom of the display grid to the right of H icon.

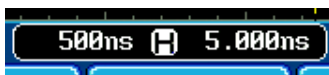

Select Horizontal Scale To select the timebase (scale), turn the *TIME/DIV* knob; left (slow) or right (fast).

TIME/DIV

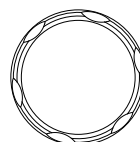

Range 1ns/div ~ 100s/div, 1-2-5 increments

The Time/Division rate is displayed to the left of the H icon at the bottom of the screen.



Display bar The display bar indicates how much of the waveform is displayed on the screen at any given time. Changes to timebase will be reflected on the display bar.



Stop mode In the Stop mode, the waveform size changes according to the scale.

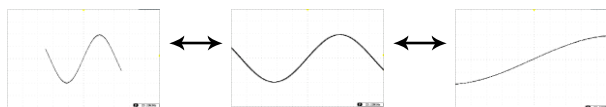

Note

The Sample rate changes according to the time/division and record length. See page 109.

Vertical Position/Scale

For more detailed configuration, see page 137.

Set Vertical Position

To move the waveform up or down, turn the *vertical position knob* for each channel.



As the waveform moves, the vertical position of the cursor appears on the display.

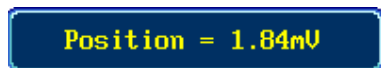

Run/Stop mode

The waveform can be moved vertically in both Run and Stop mode.

Select Vertical Scale

To change the vertical scale, turn the *VOLTS/DIV* knob; left (down) or right (up).

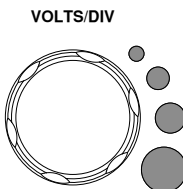

Range

1mV/div ~ 10V/div
1-2-5 increments





































The vertical scale indicator for each channel on the bottom of the display changes accordingly.



Automatic Measurement











The automatic measurement function measures and updates major items for Voltage/Current, Time, and Delay type measurements. Measurements can be made with both the analog channels and the digital channels*, however the digital channels are only limited to a select number of time measurements. *Logic analyzer option needed for digital channels.





Measurement Items









	V/I Measurements	Time Meas.	Delay Meas.
Overview	Pk-Pk  Max  Min  Amplitude  High  Low  Mean  Cycle Mean  RMS  Cycle RMS  Area  Cycle Area  ROVShoot  FOVShoot  RPREShoot  FPREShoot 	Frequency*  Period*  RiseTime  FallTime  +Width*  -Width*  DutyCycle*  +Pulses  -Pulses  +Edges  -Edges 	FRR  FRF  FFR  FFF  LRR  LRF  LFR  LFF  Phase 











*The logic analyzer option is needed to use the digital channels for these automatic measurements.

Voltage/Current Measurement
 Pk-Pk (peak to peak)  Difference between positive and negative peak. (=max - min)

Max		Positive peak.
Min		Negative peak.
Amplitude		Difference between the global high and value and the global low value, measured over the entire waveform or gated region. (=high – low)
High		Global high voltage. See page 81 for details.
Low		Global low voltage. See page 81 for details.
Mean		The arithmetic mean value is calculated for all data samples as specified by the Gating option.
Cycle Mean		The arithmetic mean value is calculated for all data samples within the first cycle found in the gated region.
RMS		The root mean square of all data samples specified by the Gating option.
Cycle RMS		The root mean square value is calculated for all data samples within the first cycle found in the gated region.
Area		Measures the positive area of the waveform and subtracts it from the negative area. The ground level determines the division between positive and negative areas.

Cycle Area		The Summation based on all data samples within the first cycle found in the gated region.
ROVShoot		Rise overshoot
FOVShoot		Fall overshoot
RPREShoot		Rise preshoot
FPREShoot		Fall preshoot

Time Measurement	Frequency		Frequency of the waveform.
	Period		Waveform cycle time. (=1/Freq)
	RiseTime		The time required for the leading edge of the first pulse to rise from the low reference value to the high reference value.
	FallTime		The time required for the falling edge of the first pulse to fall from the high reference value to the low reference value.
	+Width		Positive pulse width.
	-Width		Negative pulse width.
	Duty Cycle		Ratio of signal pulse compared with whole cycle. =100x (Pulse Width/Cycle)
	+Pulses		Measures the number of positive pulses.

	-Pulses		Measures the number of negative pulses.
	+Edges		Measures the number of positive edges.
	-Edges		Measures the number of negative edges.
Delay Measurement	FRR		Time between: Source 1 first rising edge and Source 2 first rising edge.
	FRF		Time between: Source 1 first rising edge and Source 2 first falling edge.
	FFR		Time between: Source 1 first falling edge and Source 2 first rising edge.
	FFF		Time between: Source 1 first falling edge and Source 2 first falling edge.
	LRR		Time between: Source 1 first rising edge and Source 2 last rising edge.
	LRF		Time between: Source 1 first rising edge and Source 2 last falling edge.
	LFR		Time between: Source 1 first falling edge and Source 2 last rising edge.
	LFF		Time between: Source 1 first falling edge and Source 2 last falling edge.

Phase



The phase difference of two signals, calculated in degrees.

$$\frac{t1}{t2} \times 360^\circ$$



Note

The in-built help system can be used to see detailed automatic measurement definitions.

Add Measurement

The *Add Measurement* function allows you to add up to eight automatic measurement items on the bottom of the screen from any channel source.

Add Measurement Item

1. Press the *Measure* key.
2. Press *Add Measurement* from the bottom menu.
3. Choose either a *V/I*, *Time* or *Delay* measurement from the side menu and choose the type of measurement you wish to add.

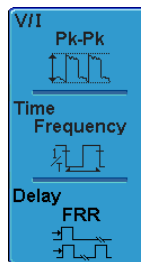
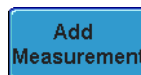

V/I Pk-Pk, Max, Min, Amplitude, High, (Voltage/ Low, Mean, Cycle Mean, RMS, Current) Cycle RMS, Area, Cycle Area, ROVShoot, FOVShoot, RPRESshoot, FPRESshoot

Time	Frequency, Period, RiseTime, FallTime, +Width, -Width, Duty Cycle, +Pulses, -Pulses, +Edges, -Edges
Delay	FRR, FRF, FFR, FFF, LRR, LRF, LFR, LFF, Phase

- All measurements will be displayed in a window on the bottom of the screen. The channel number and channel color indicate the measurement source.
For the analog inputs: yellow = CH1, blue = CH2, pink = CH3, green = CH4.



Choose a Source The channel source for measurement items can be set either before or when selecting a measurement item.

- To set the source, press either the *Source1* or *Source2* key from the side menu and choose the source. Source 2 is only applicable for delay measurements.

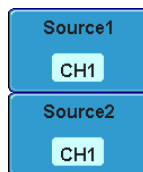

Range CH1~ CH4, Math*, D0~D15**

*The math source cannot include any digital (D0~D15) inputs.

**Only available with the Logic Analyzer option.

Remove Measurement

Individual measurements can be removed at any time using the Remove Measurement function.

Remove Measurement Item

1. Press the *Measure* key.

A grey, rounded rectangular button with the word "Measure" in white text.

2. Press *Remove Measurement* from the bottom menu.

A blue rectangular button with rounded corners and a thin white border, containing the text "Remove Measurement" in white.

3. Press *Select Measurement* and select the item that you want to remove from the measurement list.

A blue rectangular button with rounded corners and a thin white border, containing the text "Select Measurement" in white.

Remove All Items Press *Remove All* to remove all the measurement items.

A blue rectangular button with rounded corners and a thin white border, containing the text "Remove All" in white.

Gated mode

Some automatic measurements can be limited to a “gated” area between cursors. Gating is useful for measuring a magnified waveform or when using a fast time base. The Gated mode has three possible configurations: Off (Full Record), Screen and Between Cursors.

Set Gating Mode 1. Press the *Measure* key.



2. Press *Gating* from the bottom menu.



3. Choose one of the gating modes from the side menu: *Off (full record)*, *Screen*, *Between Cursors*

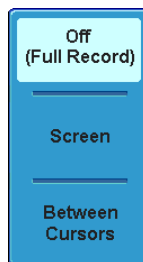

Cursors On
Screen

If *Between Cursors* is selected, the cursor positions can be edited by using the cursor menu.

Page 85

Display All mode

Display All mode shows and updates all items from Voltage and Time type measurements.

View Measurement Results

1. Press the *Measure* key.

Measure

2. Press *Display All* from the bottom menu.

Display All
OFF

3. Press Source from the side menu and choose a measurement source.

Source
CH1

Range CH1~CH4, Math, D0~D15

4. The results of Voltage and Time type measurements appear on the display.

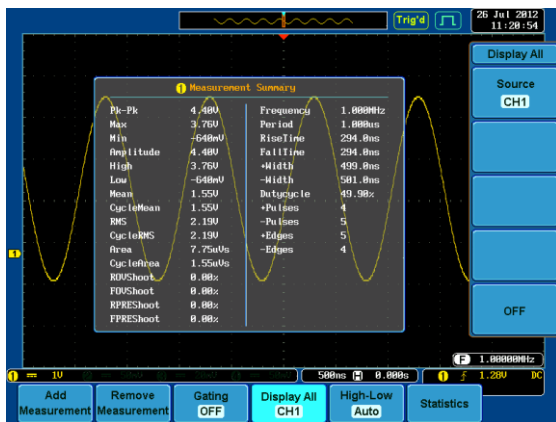

Remove Measurements

To remove the measurement results, press *OFF*.

OFF

Delay Measurements	Delay type measurement is not available in this mode as only one channel is used as the source. Use the Individual measurement mode (page 76) instead.
--------------------	--

Digital Channels	Only Frequency, Period, +Width, -Width and Duty Cycle measurements are supported for digital channels.
------------------	--

High Low Function

Background	The High-Low function is used to select the method for determining the value of the High-Low measurement values.
------------	--

Auto	Automatically chooses the best high-low setting for each waveform when measuring.
------	---

Histogram	Uses histograms to determine the high-low values. This mode ignores any preshoot and overshoot values. This mode is particularly useful for pulse-type waveforms
-----------	--

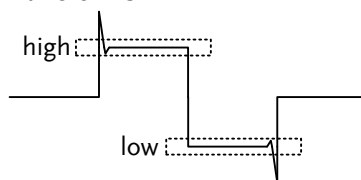

Min-max Sets the high-low values as the measured minimum or maximum measured values.

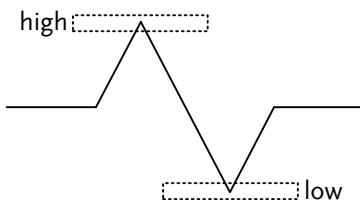

Set High-Low

1. Press the *Measure* key.



2. Press *High-Low* from the bottom menu.



3. Select the type of High-Low settings from the side menu.

High-Low Settings: Histogram, Min-Max, Auto

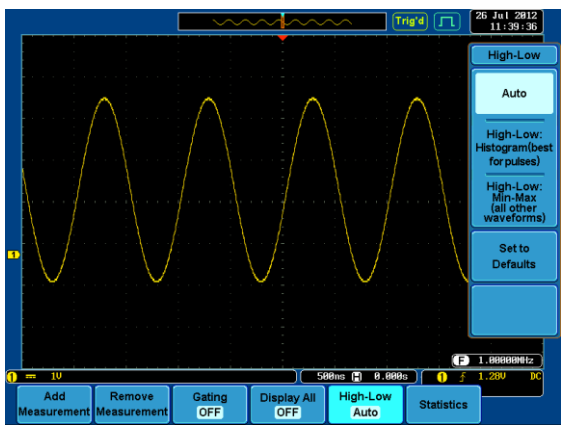

Restore Default High-Low Settings

To return to the default High-Low settings, press *Set to Defaults*.



Statistics

Background	The Statistics function can be used to view a number of statistics for the selected automatic measurements. The following information is displayed with the Statistics function:	
	Value	Currently measured value
	Mean	The mean value is calculated from a number of automatic measurement results. The number of samples used to determine the mean can be user-defined.
	Min	The minimum value observed from a series of measured results for the selected automatic measurement items.
	Max	The maximum value observed from a series of measured results for the selected automatic measurement items.
	Standard Deviation	The variance of the currently measured value from the mean. The standard deviation equals the squared root of the variance value. Measuring the standard deviation can, for example, determine the severity of jitter in a signal. The number of samples used to determine the standard deviation can be user-defined.

Set High-Low 1. Press the *Measure* key.



2. Select at least one automatic measurement.

Page 76

- Set the number of samples to be used in the mean and standard deviation calculations.



Samples: 2~1000

- Press *Statistics* from the bottom menu and turn the Statistics function on.



- The statistics will appear at the bottom of the display in a table.



- Reset Statistics To reset the statistics calculations, press *Reset Statistics*.



Cursor Measurement

Horizontal or vertical cursors are used to show the position and values of waveform measurements and math operation results. These results cover voltage, time, frequency and other math operations. When the cursors (horizontal, vertical or both) are activated, they will be shown on the main display unless turned off. (page 129).

Use Horizontal Cursors

Panel Operation/ Range 1. Press the *Cursor* key once.



2. Press *H Cursor* from the bottom menu if it is not already selected.

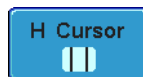

3. When the H Cursor is selected, repeatedly pressing the *H Cursor* key or the *Select* key will toggle which cursor is selected.

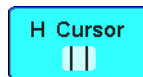

OR

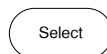

Range	Description
∷	Left cursor (1) movable, right cursor position fixed
∷	Right cursor (2) movable, left cursor position fixed
	Left and right cursor (1+2) movable together

4. The cursor position information appears on the top left hand side of the screen

①	-3.74ms	1.40V
②	7.84ms	1.40V
△	11.5ms	△0.00V
	dV/dt	0.00V/s

- Cursor ① Hor. position, Voltage/Current
- Cursor ② Hor. position, Voltage/Current
- △ Delta (difference between cursors)
- dV/dt or dI/dt

5. Use the *Variable* knob to move the movable cursor(s) left or right.

VARIABLE

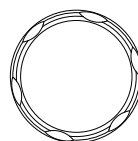

Select Units

6. To change the units of the horizontal position, press *H Unit*.

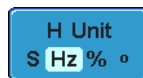

Units S, Hz, % (ratio), °(phase)

Phase or Ratio Reference

7. To set the 0% and 100% ratio or the 0° and 360° phase references for the current cursor positions, press *Set Cursor Positions As 100%*.

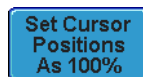

Example

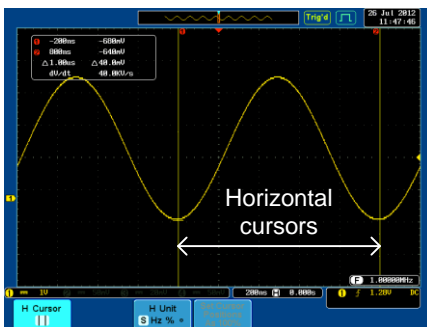

FFT

FFT cursors use different vertical units. For FFT details, see page 96.

□	1.0175GHz	21.2dB
○	2.2700GHz	-51.4dB
△	1.2525GHz	△72.6dB
	d/dt	-58.0ndB/Hz

- Cursor ❶ Hor. position, dB/Voltage
- Cursor ❷ Hor. Position, dB/Voltage
- △ Delta (difference between cursors)
- dV/dt or d/dt

Example

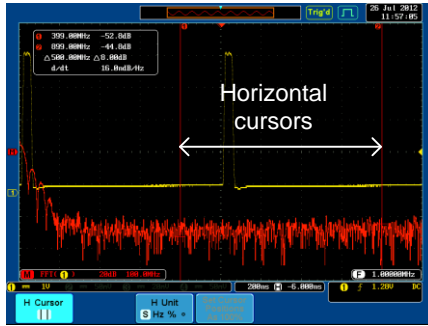

XY Mode

XY mode cursors measure a number of X by Y measurements.

❶ (X) Versus ❷ (Y)	❶	❷	△
t:	-625ns	625ns	1.25us
Rectangular 	x: -4.08U y: -752mU	-3.88U -752mU	200nU 0.00U
Polar 	r: 4.14U θ: -169°	3.95U -169°	200nU 0.00°
Product 	x×y: 3.06UU	2.91UU	0.00UU
Ratio	y÷x: 184mU/U	193mU/U	0.00U/U

- Cursor ❶ Time, rectangular, polar coordinates, product, ratio.
- Cursor ❷ Time, rectangular, polar coordinates, product, ratio.



Delta (difference between cursors)

Example

Horizontal
cursors

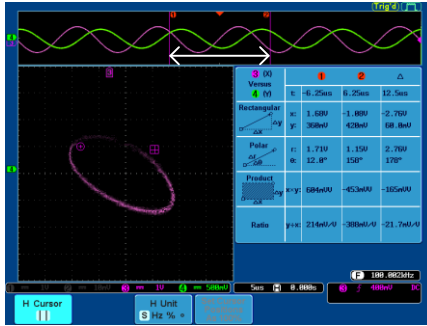

Use Vertical Cursors

Panel Operation/ Range 1. Press the *Cursor* key twice.

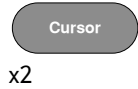

x2

2. Press *V Cursor* from the bottom menu if it is not already selected.

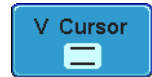

3. When the *V Cursor* is selected, repeatedly pressing the *V Cursor* key or the *Select* key will toggle which vertical cursor is selected.

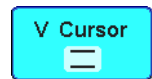

OR



Range



Upper cursor movable, lower cursor position fixed



Lower cursor movable, upper cursor position fixed



Upper and lower cursor movable together

4. The cursor position information appears on the top left hand side of the screen.

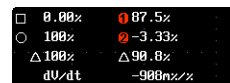

Time: cursor 1, cursor 2



Voltage/Current: cursor1, cursor2



Delta (difference between cursors)

dV/dt or dI/dt

5. Use the *Variable* knob to move the cursor(s) up or down.

VARIABLE

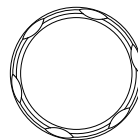

Select Units

6. To change the units of the vertical position, press *V Unit*.

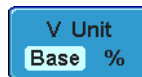

Units Base (source wave units), % (ratio)

Base or Ratio Reference

7. To set the 0% and 100% ratio references for the current cursor position, press *Set Cursor Positions As 100%*.

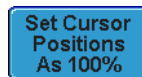

Example

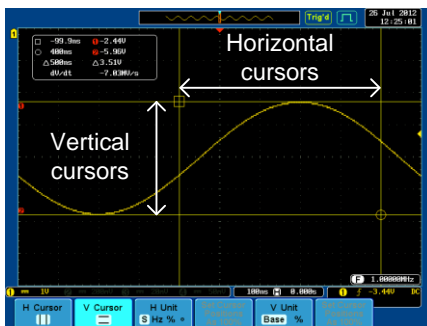

FFT

FFT has different content. For FFT details, see page 96.

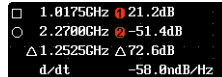

- , ○ Frequency/Time: cursor1, cursor2
- ①, ② dB/V: cursor1, cursor2
- △ Delta (difference between cursors)
- d/dt

Example

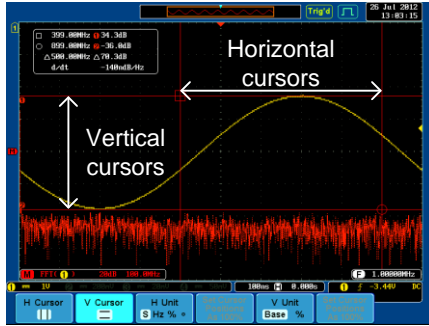

XY Mode

XY mode cursors measure a number of X by Y measurements.

1 (X) Versus 2 (Y)	1 2 Δ		
	t:		
Rectangular 	x: -1.88V y: 2.00V	120nV 0.00V	2.00V -2.00V
Polar 	r: 2.74V θ: 133°	120nV 0.00°	2.82V -45.0°
Product 	x×y: -3.76V	0.00V	-4.00V
Ratio y÷x:	-1.06V/V	0.00V/V	-1.00V/V

Cursor **1** Rectangular, polar co-ordinates, product, ratio.

Cursor **2** Rectangular, polar co-ordinates, product, ratio.

Δ Delta (difference between cursors)

Example

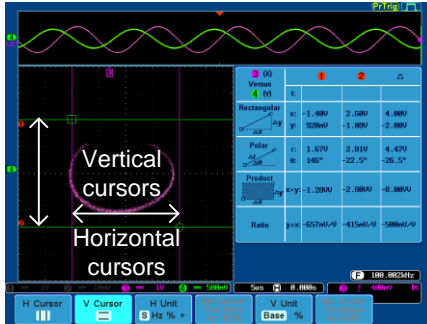

Math Operation

Overview

Background	Math operation runs addition, subtraction, multiplication, division, FFT, or certain advanced math functions for waveform manipulations using the input signals or reference waveforms (Ref1~4) and shows the result on the display. The resulted waveform characteristics can be measured using the cursors.
Addition (+)	Adds the amplitude of two signals. Source CH1~4, Ref1~4
Subtraction (-)	Extracts the amplitude difference between two signals. Source CH1~4, Ref1~4
Multiplication (×)	Multiplies the amplitude of two signals. Source CH1~4, Ref1~4
Division (÷)	Divides the amplitude of two signals. Source CH1~4, Ref1~4
FFT	Runs FFT calculations on a signal. Four types of FFT windows are available: Hanning, Hamming, Rectangular, and Blackman. Source CH1~4, Ref1~4, f(x)
d/dt	Differentiate the source waveform. Source CH1~4, Ref1~4, f(x)
∫dt	Integrate the source waveform with respect to time. Source CH1~4, Ref1~4, f(x)

√	Performs a square root calculation.	
	Source	CH1~4, Ref1~4, f(x)
Hanning FFT Window	Frequency resolution	Good
	Amplitude resolution	Not good
	Suitable for....	Frequency measurement on periodic waveforms
Hamming FFT Window	Frequency resolution	Good
	Amplitude resolution	Not good
	Suitable for....	Frequency measurement on periodic waveforms
Rectangular FFT Window	Frequency resolution	Very good
	Amplitude resolution	Bad
	Suitable for....	Single-shot phenomenon (this mode is the same as having no window at all)
Blackman FFT Window	Frequency resolution	Bad
	Amplitude resolution	Very good
	Suitable for....	Amplitude measurement on periodic waveforms

Addition/Subtraction/Multiplication/Division

Panel Operation 1. Press the *Math* key.



2. Press the *Math* key on the lower bezel.

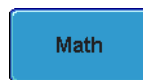

3. Select *Source 1* from the side menu

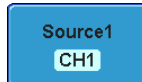

Range CH1~4, Ref~4

4. Press *Operator* to choose the math operation.

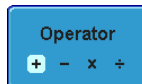

Range +, -, x, ÷

5. Select *Source 2* from the side menu.

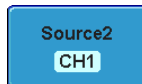

Range CH1~4, Ref~4

6. The math measurement result appears on the display. The vertical scale of the math waveform appears at the bottom of the screen.



From left: Math function, source1, operator, source2, Unit/div

Example

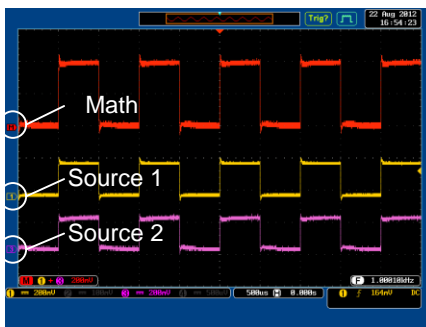

Position and Unit To move the math waveform vertically, press the *Position* key from the side menu and use the Variable knob to set the position.

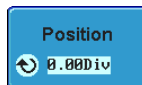

Range -12.00 Div ~ +12.00 Div

To change the unit/div settings, press *Unit/div*, then use the Variable knob to change the unit/div.

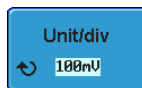

The units that are displayed depend on which operator has been selected, and whether the probe for the selected channel has been set to voltage or current.

Operator:	Unit/div:
Multiplication	VV, AA or W
Division	V/V, A/A
Addition/Subtraction	V or A

Turn Off Math To turn off the Math result from the display, press the *Math* key again.



FFT

Panel Operation 1. Press the *Math* key.



2. Press *FFT* from the bottom menu.



3. Select the *Source* from the side menu.



Range CH1~4, Ref~4, f(x)*

*the f(x) source is set in the advanced math function, page 100.

4. Press the *Vertical Units* key from the side menu to select the vertical units used.

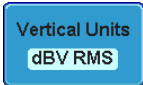

Range Linear RMS, dBV RMS

5. Press the *Window* key from the side menu and select the window type.



Range Hanning, Hamming, Rectangular, and Blackman.

6. The FFT result appears. For FFT, the horizontal scale changes from time to frequency, and the vertical scale from voltage/current to dB/RMS.

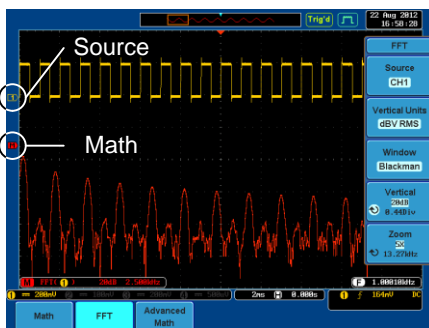

Position and Scale

To move the FFT waveform vertically, press *Vertical* until the *Div* parameter is highlighted and then use the Variable knob.



Range -12.00 Div ~ +12.00 Div

To select the vertical scale of the FFT waveform, press *Vertical* until the *dB* or *voltage* parameters are highlighted and then use the Variable knob.

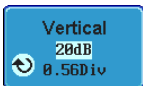

Range 2mV~1kV RMS, 1~20 dB

Zoom and Offset To zoom into the FFT waveform, press *Zoom* until the *x times* parameter is highlighted and then use the Variable knob.

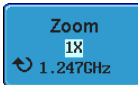

Range 1x ~ 20x

To horizontally offset the FFT waveform, press *Zoom* until the *frequency* parameter is highlighted and then use the Variable knob.

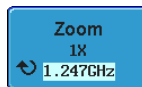

Clear FFT To clear the FFT result from the display, press the *Math* key again.



Advanced Math

Background The advanced math function is used to perform a number of advanced math functions such as differentiation or integration of a source waveform.

The $f(x)$ source function (as used in the FFT function) can also be set from the advanced menu.

Panel Operation 1. Press the *Math* key.



2. Press *Advanced Math* from the bottom menu.

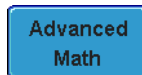

3. Select the *Operator* from the side menu.



Range $d/dt, \int dt, \sqrt{\quad}$

4. Select the *Source* from the side menu.



Range CH1~4, Ref~4, f(x)*

*the f(x) source is set with the *Edit F(x)* function, page 100.

5. The math result appears. For the differential/integral operations, the unit/div scale changes accordingly.

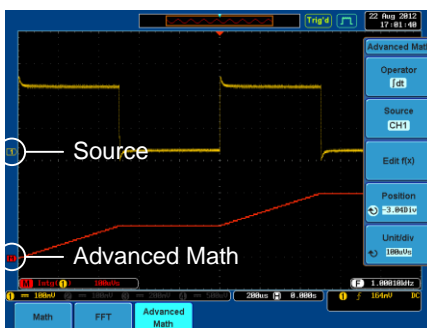

Position and Unit To move the math waveform vertically, press *Position* and use the Variable knob.

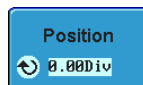

Range -12.00 Div ~ +12.00 Div

To select the vertical scale of the math waveform, press *Unit/div* and use the Variable knob.

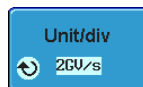





Clear Advanced Math To clear the advanced math result from the display, press the *Math* key again.

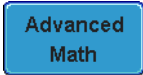

Edit F(x)

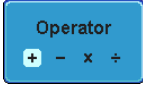
Background The $f(x)$ source is a user-defined math function that can be used as a source waveform for the FFT or advanced math functions. The $f(x)$ source waveform is created by the addition, subtraction, multiplication or division of two input waveforms.

- | | | |
|------------------------|--|---|
| Panel Operation | <ol style="list-style-type: none"> 1. Press the <i>Math</i> key. |  |
| | <ol style="list-style-type: none"> 2. Press <i>Advanced Math</i> from the bottom menu. |  |
| | <ol style="list-style-type: none"> 3. Press the <i>Edit f(x)</i> key to edit the $f(x)$ waveform. |  |
| | <ol style="list-style-type: none"> 4. Select <i>Source 1</i> from the side menu
Range CH1~4 |  |
| | <ol style="list-style-type: none"> 5. Press <i>Operator</i> to choose the math operation.
Range +, -, x, ÷ |  |
| | <ol style="list-style-type: none"> 6. Select <i>Source 2</i> from the side menu.
Range CH1~4 |  |
| | <ol style="list-style-type: none"> 7. The $f(x)$ source waveform is now set, press <i>Go Back</i> to return to the Advanced Math menu. |  |

C ONFIGURATION

Acquisition.....	103
Select Acquisition Mode.....	103
Digital Filter	105
Show Waveform in XY Mode.....	106
Set the Sampling Mode.....	108
Set the Record Length.....	109
Segmented Memory Acquisition Overview	111
Segments Display	113
Set the Number of Segments.....	114
Run Segmented Memory.....	114
Navigate Segmented Memory	116
Play Through Each Segment.....	117
Segment Measurement	118
Display All.....	118
Automatic Measurement.....	119
Segment Info	123
Display.....	124
Display Waveform as Dots or Vectors	124
Set the Level of Persistence	125
Set the Intensity Level	125
Set the Waveform Intensity Type	127
Select Display Graticule	128
Freeze the Waveform (Run/Stop).....	129
Turn Off Menu.....	129
Horizontal View	130
Move Waveform Position Horizontally.....	130
Select Horizontal Scale.....	131
Select Waveform Update Mode	132
Zoom Waveform Horizontally	133
Play / Pause	135

Vertical View (Channel)	137
Move Waveform Position Vertically	137
Select Vertical Scale	137
Select Coupling Mode	138
Input Impedance	139
Invert Waveform Vertically	139
Limit Bandwidth	140
Expand by Ground/Center	141
Select Probe Type	142
Select Probe Attenuation Level	142
Set the Deskew	143
Trigger	144
Trigger Type Overview	144
Trigger Parameter Overview	147
Setup Holdoff Level	151
Setup Trigger Mode	152
Using the Edge Trigger	152
Using Advanced Delay Trigger	154
Using Pulse Width (Glitch) Trigger	155
Using Video Trigger	157
Pulse Runt trigger	158
Using Rise and Fall (Slope) Trigger	160
Using the Timeout Trigger	161
Search	163
Configuring Search Events	163
Copying Search Event To/From Trigger Events	165
Search Event Navigation	165
Save Search Marks	166
Setting/Clearing Single Search Events	167
System Info / Language / Clock	168
Select Menu Language	168
View System Information	169
Erase Memory	169
Turn the Buzzer On/Off	170
Set Date and Time	170

Acquisition

The Acquisition process samples the analog input signals and converts them into digital format for internal processing.

Select Acquisition Mode

Background	The acquisition mode determines how the samples are used to reconstruct a waveform.
Sample	This is the default acquisition mode. Every sample from each acquisition is used.
Peak detect	Only the minimum and maximum value pairs for each acquisition interval (bucket) are used. This mode is useful for catching abnormal glitches in the signal.
Average	Multiple acquired data is averaged. This mode is useful for drawing a noise-free waveform. To select the average number, use the Variable knob. Average number: 2, 4, 8, 16, 32, 64, 128, 256

Panel Operation 1. Press the *Acquire* key.



2. To set the Acquisition mode, press *Mode* on the bottom menu.



- 3. Select an acquisition mode from the side menu.
- 4. If *Average* was chosen, set the number of samples to be used for the average function.

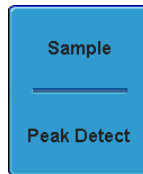

Mode Sample, Peak Detect,
 Average



Average 2, 4, 8, 16, 32, 64, 128,
sample 256

Example

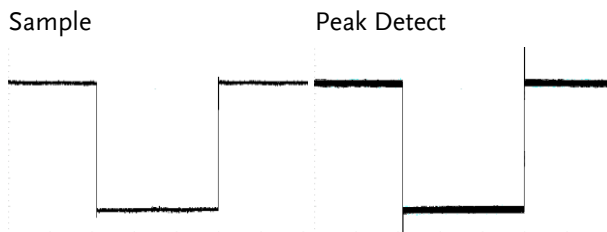

Average (256 times)

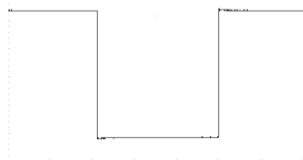

Digital Filter

Background The digital filter function can remove unwanted components, such as noise, from the desired signal.

The filtering only functions during continuous acquisition using either the Sample or Peak detect mode.

The cut-off frequency range and step resolution of the digital filter is expressed as a fraction of the underlying sample rate, as shown below.

Range	1% ~ 49% of sample rate, Off
Resolution	1% of sample rate

Panel Operation

1. Press the *Acquire* key.



2. Press *Mode* on the bottom menu.



3. Set the acquisition mode to Sample or Peak Detect.

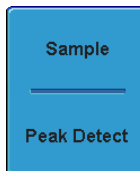

4. Press *Digital Filter* and set the digital frequency using the Variable knob.







Turn the Variable knob fully anticlockwise to turn the digital filter off.

Show Waveform in XY Mode

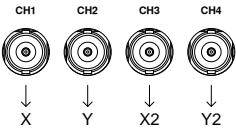
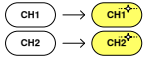
Background The XY mode maps the input of channel 1 to the input of channel 2. In 4 channel models, the input of channel 3 can be mapped to the input of channel 4. This mode is useful for observing the phase relationship between waveforms.

Reference waveforms can also be used in XY mode. Ref1 is mapped to Ref2 and Ref3 is mapped to Ref4. Using the reference waveforms is the same as using the channel input waveforms.

- Connection**
1. Connect the signals to Channel 1 (X-axis) and Channel 2 (Y-axis) or Channel 3 (X2-axis) and Channel 4 (Y2-axis).
 
 2. Make sure a channel pair is active (CH1&CH2 or CH3&CH4). Press the Channel key if necessary. A channel is active if the channel key is lit.
 

- Panel Operation**
1. Press the *Acquire* menu key.
 
 2. Press XY from the bottom menu.
 
 3. Choose *Triggered XY* from the side menu.
 

X-Y mode is split into two windows. The top window shows the signals over the full time range. The bottom window shows XY mode.

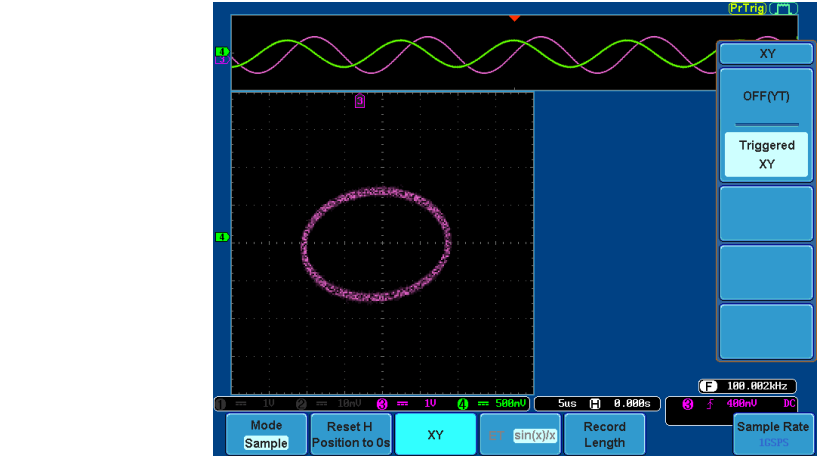

To move the X Y waveform position, use the vertical position knob: Channel 1 knob moves the X Y waveform horizontally, Channel 2 knob moves the X Y waveform vertically. Similarly, the X2 and Y2 axis can be positioned using the channel 3 and channel 4 vertical position knobs.

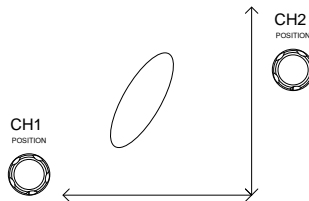

The horizontal position knob and Time/Div knob can still be used under the XY mode.

Turn Off XY Mode To turn off XY mode, choose *OFF (YT)* mode.

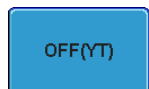

XY Mode Cursors can be used with XY mode. Page 85
 See the Cursor chapter for details.

Set the Sampling Mode

Background The GDS-2000A has two types of sampling modes: ET (Equivalent Time) and $\text{Sin}(x)/x$ interpolation. Equivalent time sampling is able to achieve a sample rate of 100GSa/s when sampling periodic waveforms. $\text{Sin}(x)/x$ interpolation uses a sinc interpolation formula to reconstruct a continuous signal between sampled points.

$\text{Sin}(x)/x$ One sample of data is used to reconstruct a single waveform. $\text{Sin}(x)/x$ sampling should be used when the time base is relatively slow or if single shot events need to be captured.

Equivalent-time sampling Sampled data is accumulated a number of times to reconstruct a single waveform. This increases the sampling rate, but can only be used for repetitive signals. This mode is usually used when the time base is too fast for real-time sampling.

Panel Operation 1. Press the *Acquire* key.



2. Press the *ET/sin(x)/x* key on the bottom menu to toggle between equivalent time sampling (ET) and $\text{sin}(x)/x$ interpolation.



The sampling rate will be shown on the bottom right-hand corner.

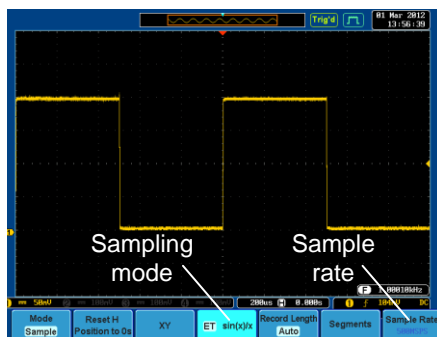

Set the Record Length

Background

The number of samples that can be stored is set by the record length. Record length is important in an oscilloscope as it allows longer waveforms to be recorded and/or allows higher sampling rates to be achieved when equivalent time sampling is used.

There are two record length settings, Auto and Short. The Auto setting will set the record length to maximum record length available, dependent on the scope settings. The Short setting will set the record length to 1k.

The maximum record length for the GDS-2000A depends on the number of active channels, which channels are active, and whether the normal or single shot triggering mode is used. The table below describes the record lengths that are available for each triggering mode.

Channel Setting	Trigger Mode		
	Single	Normal	Auto
CH1 on	2M	1M	1M
CH2 on	2M	1M	1M
CH3 on	2M	1M	1M
CH4 on	2M	1M	1M
CH1, CH3 on	2M	1M	1M
CH1, CH4 on	2M	1M	1M
CH2, CH3 on	2M	1M	1M
CH2, CH4 on	2M	1M	1M
CH1, CH2 on	1M	500k	500k
CH3, CH4 on	1M	500k	500k
CH1, CH2, CH3 on	1M	500k	500k
CH1, CH2, CH4 on	1M	500k	500k
CH2, CH3, CH4 on	1M	500k	500k
CH1, CH3, CH4 on	1M	500k	500k
CH1, CH2, CH3, CH4 on	1M	500k	500k

Panel Operation 1. Press the *Acquire* key.



2. Press the *Record Length* key on the bottom menu and choose *Auto* or *Short* mode.



The sampling rate may also be changed when the record length is changed.

Segmented Memory Acquisition Overview

The advanced segmented memory utility allows the scope memory to be divided into different segments. Each time the scope is triggered, it only acquires data for one segment of memory at a time. This allows you to optimize the scope memory to only perform signal acquisition during important signal events.

For example, for a signal with a number of pulses, normally the oscilloscope will acquire the signal until the acquisition memory of the scope is filled up and then it will re-arm the trigger and then capture again. This could result in a number of events not being captured or captured at a less-than-desired resolution (depending on the horizontal scale and sampling rate). However, the segmented memory function would effectively allow you to capture more of the signal than you would otherwise. The diagrams below illustrate this point.

Normal acquisition mode example:

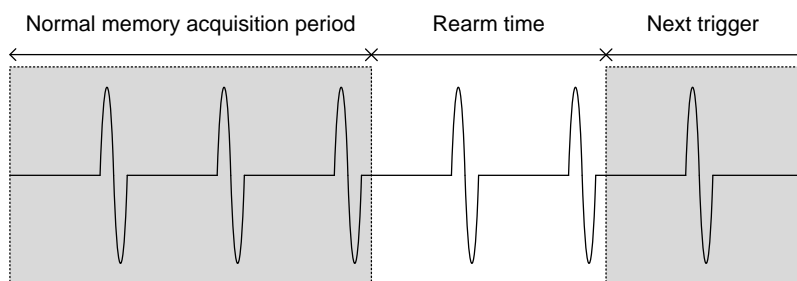

Segmented memory acquisition example:

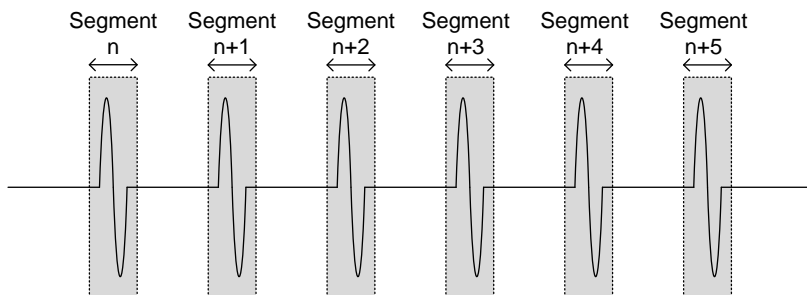

As shown below, the memory is divided into segments to increase the number of events that can be effectively captured with the same acquisition memory. Also notice that the scope doesn't need to rearm the trigger between each segment, this makes the segmented memory function especially useful for high speed signals. The time between each segment is also recorded so that accurate signal timing can also be measured.

The segmented memory function also supports automatic measurements for each segment or statistics for all the captured segments.

The Advanced Segment Memory Utility is applicable for both analog and digital channels.

Segments Display

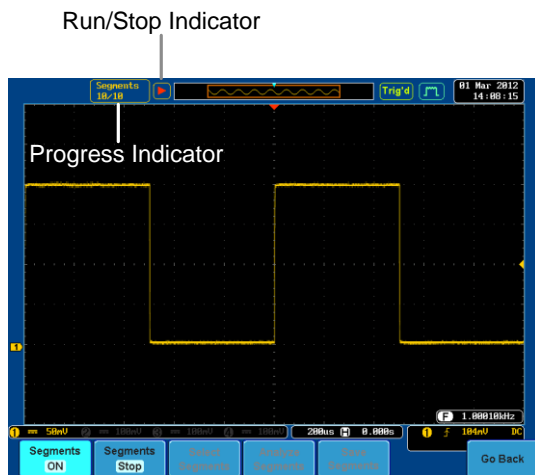

Progress Indicator



Indicates the number of segments that have to be captured relative to the set number of segments.

Run/Stop Indicator





Stop: The segments have finished acquiring or have been stopped.



Run: The scope is ready to acquire segments.

Set the Number of Segments

Note Before the Segment function can be used, set the trigger settings as appropriate for the signal you wish to use.

- Panel Operation**
1. Press the *Acquire* key. 
 2. Press *Segments* on the bottom menu. 
 3. Press *Select Segments* and set the number of segments from the side menu. 

Num of Seg	1~2048
Set to Maximum	Sets to 0 segments
Set to Minimum	Sets to 2048 segments

Note The Select Segments icon is only available when when Segments = OFF or when Segments is in the STOP mode (see the section below).

Run Segmented Memory

Background Before the Segmented Memory function can be used, set the trigger settings as appropriate for the signal you wish to use. See page 144 for configuring the trigger settings.

- Run Segments**
1. Toggle *Segments On* from the bottom menu.



Note The first time Segmented memory is turned on the segments will automatically be run. Each segment will be automatically captured. The progress of capturing the segments is shown at the top of the display.

- The scope will automatically start acquiring segments. The progress of the segmented memory capture is shown in the Progress Indicator.



The Run Indicator will be shown when in the Run mode and the Segments icon will also indicate that the function is in run mode.



- When the scope has finished acquiring segments, press *Segments Run* to toggle the mode to the *Segments Stop* mode.

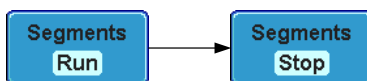

Alternatively, the *Run/Stop* can be pressed.



- The Stop Indicator will be shown when in the Stop mode.



The scope is now ready to navigate or analyze the acquired segments.

Rerun Segmented Acquisition 1. To rerun the segments, press the *Segments Stop* key to toggle the mode back to the *Segments Run* mode.



Alternatively, press the *Run/Stop* key again.

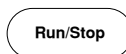

2. Repeat steps 3 and 4 in the section above when the segmented acquisition has completed.

The scope is now ready to navigate or analyze the acquired segments.

Navigate Segmented Memory

Background After the segmented memory acquisitions have been captured you can navigate through each segment one at a time.

Operation

1. Press *Select Segments* from the bottom menu. This key will be available in the Stop mode.
2. To navigate to the segment of interest, press *Current Seg* from the side menu and use the Variable knob to scroll to the segment of interest.

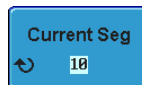

Alternatively, the Set to Minimum and Set to Maximum keys can be used to jump to the first and last segment respectively.

3. The position in time of the selected segment relative to the time of the first segment is shown in the *Segments Time* key.



Play Through Each Segment

Background When the all the segments have been acquired, the play/pause key can be used to play back through each segment.

Operation 1. Make sure the scope is *Segments Stop* mode. See page 114 for details.

2. Press the Play/Pause key to run through the acquired segments in numerical order.



- Press the Play/Pause key again to pause the playback.
- When the scope has played through to the last segment, pressing the Play/Pause key again will play through each segment again in reverse order.

Segment Measurement

Background The Segmented memory function can be used in conjunction with the automatic measurements in the Measurement menu. Please note that digital channels are not supported for measurement using segments.

Display All The Display All function will show all the acquired segments simultaneously.

Segments Measure This function will either perform statistics calculations on the segments or tabulate a list of the measurement results.

Segments Info Provides configuration information common for all the acquired memory segments.

Display All

Operation 1. Press *Analyze Segments* from the bottom menu.



Note: This key will only be available in the Stop mode.

2. Press Display All

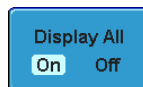

- The display will show all the acquired segments on the display simultaneously. The currently selected segment will be superimposed over the top for reference purposes.

Example

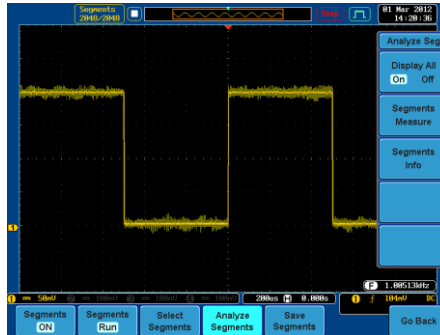

Automatic Measurement

Background

The Segments Measure function allows you to view automatic measurements for the segments in statistical bins or as a list displaying the result of each automatic measurement.

Statistics

This function will bin the measurement results of a single automatic measurement into a user-defined number of bins. This allows you to easily view statistics for a large number of segments. For example, the statistics function will display the number of results for each bin and the measurement range of each bin for the selected automatic measurement.

Measurement List Puts all the measurement results for a segment in a list. All the currently selected automatic measurement results are listed. A maximum of 8 automatic measurements can be used with this function.

Note To use automatic measurements with the segmented memory, automatic measurements must first be selected from the Measure menu before the segmented memory function is run.

Digital channels cannot be used with this function.

Setup Press the *Measure* key and select any *single* source measurement from the *Add Measurement* menu.



See page 76 for details on how to add automatic measurements.

Operation 1. Press *Analyze Segments* from the Segments menu.

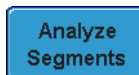

Note: This key will only be available in the Stop mode.

2. Press *Segments Measure*.

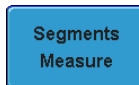

3. Select either the statistics or the measurement list from the side menu.



Statistics



List

- The statics table or measurement list appears on the display.

Note that the more segments that you have, the longer it will take to calculate the statics or list the measurement results.

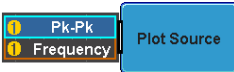
- For statistic measurements, press *Plot Source* to choose which automatic measurement to use for the statistics calculations. The statistics for only one automatic measurement can be viewed at a time.
 

- For the measurement list, press *Source* and select the source channel for measurement.
 
- Range CH1 ~ CH4

Statistics Results This function will bin the measurement results of the selected automatic measurement into a user-defined number of bins.

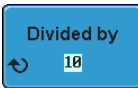
- Setup**
- To select the number of bins for the statistics, press *Divided by* and select the number of bins with the Variable knob.
 
- Range 1~20 bins

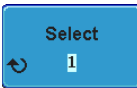
- Press *Select* and use the Variable knob to view the measurement results for each bin.
 

Example:
Statistics

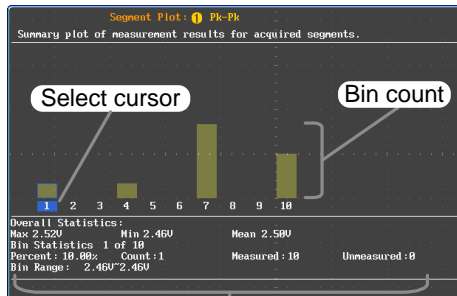

Statistics of currently selected bin

Measurement List

Puts all the measurement results for a segment in a list.

Setup

1. Press *Select* and use the variable knob to scroll through each segment.

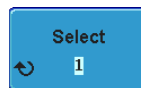

Example:
Measurement List

Select cursor

Seg.	Pk-Pk	Freq
1	2.50	1.001k
2	2.50	1.000k
3	2.48	1.000k
4	2.50	1.000k
5	2.50	995.0
6	2.52	1.000k
7	2.46	1.000k
8	2.52	1.000k
9	2.50	1.000k
10	2.52	1.001k

Segment Info

Operation

1. Press *Analyze Segments* from the bottom menu.



Note: This key will only be available in the Stop mode.

2. Press *Segments Info*.



3. A table showing all general setting information for the segmented memory acquisitions is shown on the display.

Info: Sample rate, Record length,
 Horizontal, Vertical

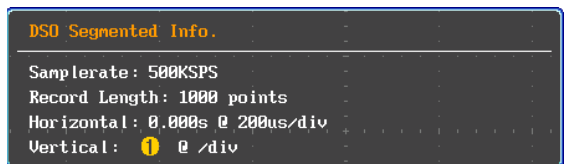

Display

The Display menu defines how the waveforms and parameters appear on the main LCD display.

Display Waveform as Dots or Vectors

Background When the waveform is displayed on screen, it can be displayed as dots or vectors.

Panel Operation 1. Press the *Display* menu key.



2. Press *Dot Vector* to toggle between Dot and Vector mode.

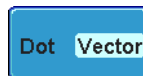

Range	Dots	Only the sampled dots are displayed.
	Vectors	Both the sampled dots and the connecting line are displayed.

Example:

Vectors (square wave)

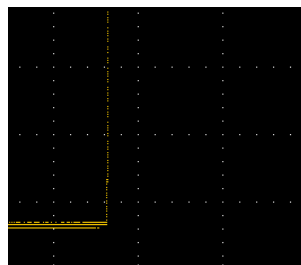
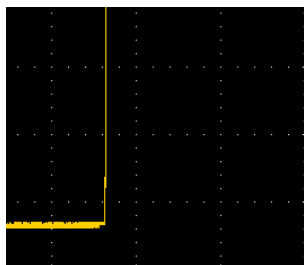

Dots (square wave)



Set the Level of Persistence

Background The persistence function allows the GDS-2000A to mimic the trace of a traditional analog oscilloscope. A waveform trace can be configured to “persist” for designated amount of time.

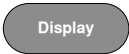
Panel Operation

1. Press the *Display* menu key. 
2. To set the persistence time, press the *Persistence* menu button on the bottom bezel. 
3. Use the Variable knob to select a persistence time. 



Time 16ms~10s, Infinite, Off

Clear To clear persistence, press *Clear Persistence*. 

Set the Intensity Level

Background The intensity level of a signal can also be set to mimic the intensity of an analog oscilloscope by setting the digital intensity level.

Panel Operation

1. Press the *Display* menu key. 
2. Press *Intensity* from the bottom menu. 

Waveform Intensity 3. To set the waveform intensity, press *Waveform Intensity* and edit the intensity.

Range 0~100%

Graticule Intensity

- To set the graticule intensity, press *Graticule Intensity* from the side menu and edit the intensity value.

Range 10~100%

Example

Waveform Intensity 0%

Waveform Intensity 100%

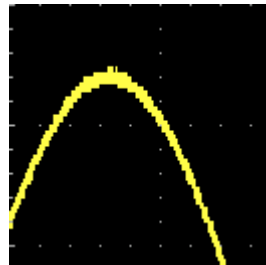
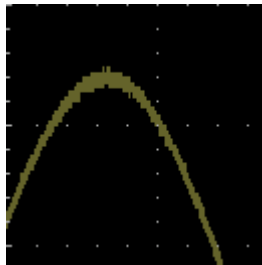

Graticule Intensity 10%

Graticule Intensity 100%

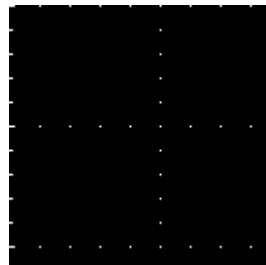

Set the Waveform Intensity Type

Background The intensity gradient of a signal can be set to grayscale or color. If intensity is set to color, the intensity gradient is analogous to a thermal color gradient where high intensity areas are colored red and low intensity areas are colored blue.

Panel Operation 1. Press the *Display* menu key.

Display

2. Press *Waveform* from the bottom menu to toggle the intensity type.

Waveform
Gray Color

Range Gray, Color

Example

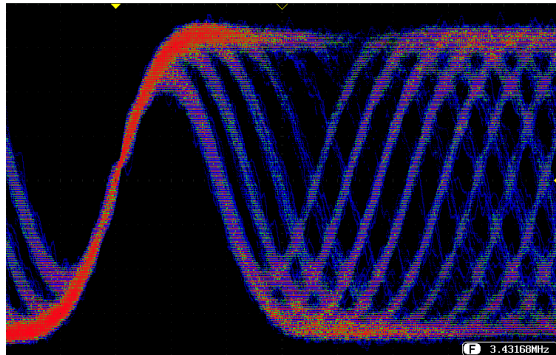

Select Display Graticule

Panel Operation 1. Press the *Display* menu key.

A grey, rounded rectangular button with the word "Display" in black text.

2. Press *Graticule* from the bottom menu.

A blue rectangular button with rounded corners and a thin black border, containing the word "Graticule" in white text.

3. From the side menu choose the graticule display type.



Full: Shows the full grid; X and Y axis for each division.



Grid: Show the full grid without the X and Y axis.



Cross Hair: Shows only the center X and Y frame.



Frame: Shows only the outer frame.

Freeze the Waveform (Run/Stop)

For more details about Run/Stop mode, see page 68.

- Panel Operation
1. Press the *Run/Stop* key. The *Run/Stop* key turns red and waveform acquisition is paused.

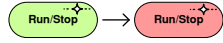

2. The waveform and the trigger freezes. The trigger indicator on the top right of the display shows Stop.



3. To unfreeze the waveform, press the *Run/Stop* key again. The *Run/Stop* key turns green again and acquisition resumes.

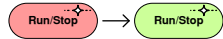

Turn Off Menu

- Panel Operation
1. Press the *Menu Off* key below the side menu keys to reduce a menu. The menu key needs to be pressed each time to reduce one menu.

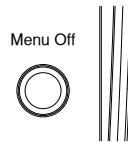

See page 35 for more information.

Horizontal View

This section describes how to set the horizontal scale, position, and waveform display mode.

Move Waveform Position Horizontally

Panel Operation The horizontal position knob moves the waveform left/right.



As the waveform moves, a position indicator on the top of the display indicates the horizontal position of the waveform in memory.

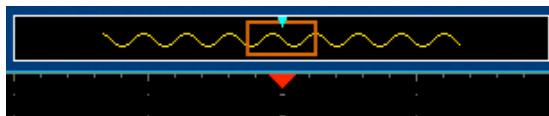

Reset Horizontal Position 1. To reset the horizontal position, press the Acquire key and then press *Reset H Position to 0s* from the bottom menu.

Acquire

Reset H
Position to 0s

Run Mode In Run mode, the memory bar keeps its relative position in the memory since the entire memory is continuously captured and updated.

Select Horizontal Scale

Select Horizontal Scale To select the timebase (scale), turn the TIME/DIV knob; left (slow) or right (fast).



Range 1ns/div ~ 100s/div, 1-2-5 increment

The timebase indicator updates as the TIME/DIV is adjusted.

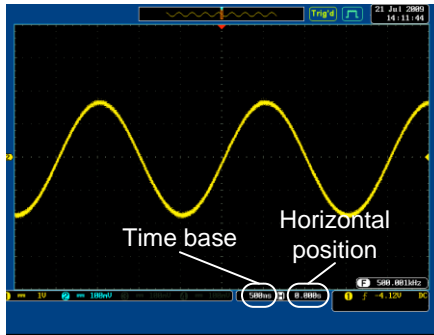

Run Mode In Run mode, the memory bar and waveform size keep their proportion. When the time base becomes slower, roll mode is activated (if trigger is set to Auto).

Stop Mode In Stop mode, the waveform size changes according to the scale.

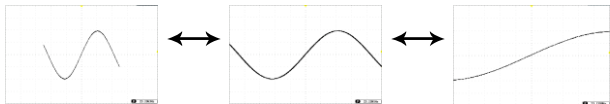

Select Waveform Update Mode

Background	The display update mode is switched automatically or manually according to the timebase and trigger.
Normal	<p>Updates the whole displayed waveform at once. Automatically selected when the timebase (sampling rate) is fast.</p> <p>Timebase $\leq 50\text{ms/div}$</p> <p>Trigger all modes</p>
Roll Mode	<p>Roll Updates and moves the waveform gradually from the right side of the display to the left. Automatically selected when the timebase (sampling rate) is slow.</p> <p>Timebase $\geq 100\text{ms/div}$</p> <p>Trigger all modes</p>

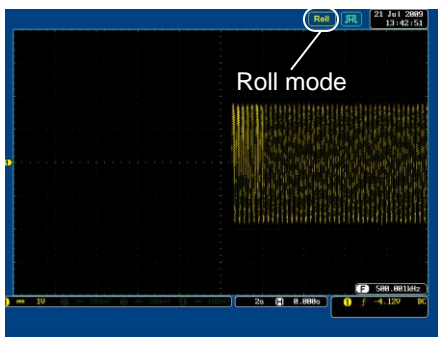

Select Roll Mode Manually 1. Press the *Trigger Menu* key.



2. Press *Mode* from the bottom menu and select *Auto (Untriggered Roll)* from the side menu.



Zoom Waveform Horizontally

Background When in Zoom mode, the screen is split into 2 sections. The top of the display shows the full record length, with the bottom of the screen showing the normal view.

Panel Operation 1. Press the *Zoom* key.

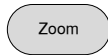

2. The Zoom mode screen appears.

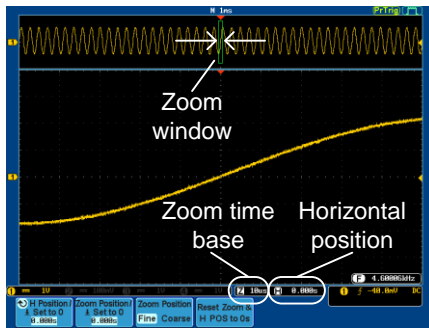

Horizontal Navigation

To scroll the waveform left or right, use the *Variable Position* knob.

VARIABLE

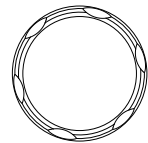

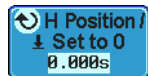

To reset the horizontal position, press *H Position/Set to 0*.

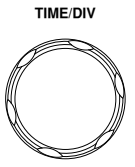

Zoom To increase the zoom range, use the *TIME/DIV* knob.

The zoom time base (Z) at the bottom of the screen will change accordingly.

Move the Zoom Window Use the *Horizontal Position* knob to pan the zoom window horizontally.

The position of the zoom window, relative to the horizontal position is shown on the *Zoom Position/Set to 0* key.

To reset the zoom position, press *Zoom Position/Set to 0*.



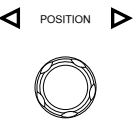
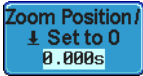

Scroll Sensitivity To alter the scrolling sensitivity of the zoom window, press the *Zoom Position* key to toggle the scrolling sensitivity.

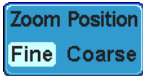
Sensitivity Fine, Coarse

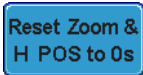

Reset the Zoom & Horizontal Position To reset both the zoom and horizontal position, press *Reset Zoom & H POS to 0s*.



Exit To go back to the original view, press the *Zoom* key again.



Play / Pause

Background The Play/Pause key can be used to play through signals in Zoom mode.

Note If the Segmented memory function is turned on, pressing the play pause key will play through memory segments. See page 117 for information.

- Panel Operation**
1. Press the *Play/Pause* menu key. 
 2. The scope will go into the Zoom Play mode and begin to scroll through the acquisition (from left to right).

The full-record length waveform will be shown in the top and the zoomed section will be shown in the bottom.

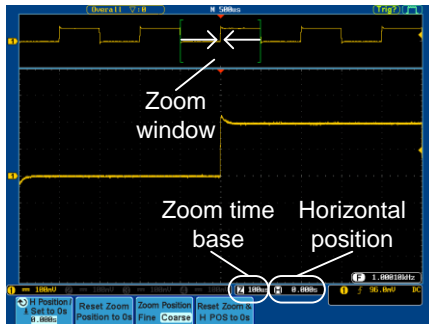

Zoom To increase the zoom range, use the *TIME/DIV* knob.

The zoom time base (Z) at the bottom of the screen will change accordingly.

TIME/DIV



Z 500us H 0.000s

Scroll Speed To alter the scrolling speed of the zoom window, press the *Zoom Position* key to toggle the scrolling speed.

Zoom Position
Fine Coarse

Sensitivity Fine, Coarse

Alternatively, use the Horizontal position knob to control the scroll speed.

- Turning the Horizontal knob determines the speed and direction of the scrolling.

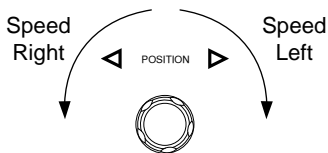

Reset the Zoom Position To reset both the zoom position, press *Reset Position to 0s*.

Reset Zoom & H POS to 0s

Pause Press the *Play/Pause* key to pause or resume playing the waveform.

▶/||

Reverse Direction Press the *Play/Pause* key when at the end of the record length to play back through the waveform in reverse.

▶/||

Exit To exit, press the *Zoom* key.

Zoom

Vertical View (Channel)

This section describes how to set the vertical scale, position, and coupling mode.





Move Waveform Position Vertically

- Panel Operation
- To move the waveform up or down, turn the *vertical position* knob for each channel.
 - As the waveform moves, the vertical position of the cursor appears at the bottom half of the display.

POSITION



Position = 0.000

- View or Reset Vertical Position
- Press a channel key. The vertical position is shown in the  *Position /*  *Set to 0* soft key.
 - To change the position, press  *Position /*  *Set to 0* to reset the vertical position or turn the *vertical position* knob to the desired level.



Run/Stop Mode The waveform can be moved vertically in both Run and Stop mode.

Select Vertical Scale

- Panel Operation
- To change the vertical scale, turn the VOLTS/DIV knob; left (down) or right (up).

VOLTS/DIV



The vertical scale indicator on the bottom left of the display changes accordingly for the specific channel.

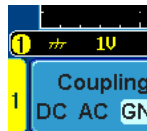

Range 1mV/div ~ 10V/div (1MΩ). 1-2-5 increments

Stop Mode In Stop mode, the vertical scale setting can be changed.

Select Coupling Mode

Panel Operation 1. Press a *channel* key.

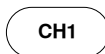

2. Press *Coupling* repeatedly to toggle the coupling mode for the chosen channel.

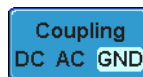

Range

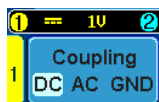

DC coupling mode. The whole portion (AC and DC) of the signal appears on the display.

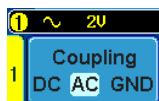

AC coupling mode. Only the AC portion of the signal appears on the display. This mode is useful for observing AC waveforms mixed with DC signals.

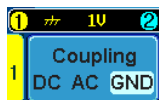

Ground coupling mode. The display shows only the zero voltage level as a horizontal line.

Example Observing the AC portion of the waveform using AC coupling

DC coupling

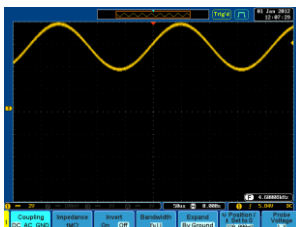

AC coupling

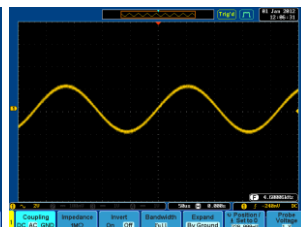

Input Impedance

Background The input impedance of the GDS-2000A is fixed at 1MΩ. The impedance is displayed in the channel menu.

View Impedance 1. Press the *Channel* key.

2. The impedance is displayed in the bottom menu.

Invert Waveform Vertically

Panel Operation 1. Press the *Channel* key.

2. Repeatedly press *Invert* to toggle Invert On or Off.

Limit Bandwidth

Background Bandwidth limitation puts the input signal into a selected bandwidth filter.

This function is useful for cutting out high frequency noise to see a clear waveform shape.

The bandwidth filters available are dependent on the bandwidth of the oscilloscope model.

Panel Operation 1. Press the *Channel* key.

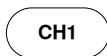

2. Press *Bandwidth* from the bottom menu.



3. Choose a bandwidth* from the side menu.

*Depending on the bandwidth of the oscilloscope.

- | | |
|-------|--|
| Range | 70MHz models: Full, 20MHz |
| | 100MHz models: Full, 20MHz |
| | 200MHz models: Full, 20MHz, 100MHz |
| | 300MHz models: Full, 20MHz, 100MHz, 200MHz |

Example

BW Full

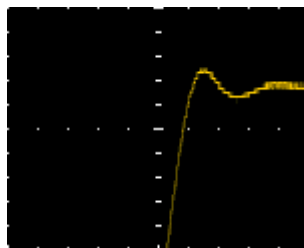

BW Limit 20MHz

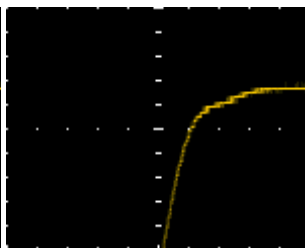

Expand by Ground/Center

Background When the voltage scale is changed, the Expand function designates whether the signal expands from the center of the signal or from the signal ground level. Expand by center can be used to easily see if a signal has a voltage bias. Expand by ground is the default setting.

Panel Operation 1. Press a *channel* key.



2. Press *Expand* repeatedly to toggle between expand *By Ground* and *Center*.



Range By Ground, By Center

Example If the vertical scale is changed when the Expand function is set to ground, the signal will expand from the ground level*. The ground level does not change when the vertical scale is changed.

If the vertical scale is changed when the Expand function is set to center, the signal will expand from the center of the signal. The ground level will suit to match the signal position.

*Or from the upper or lower edge of the screen if the ground level is off screen.

Expand by Ground

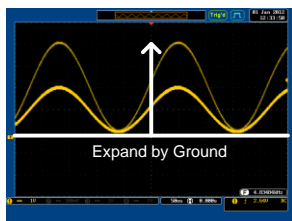

Expand by Center

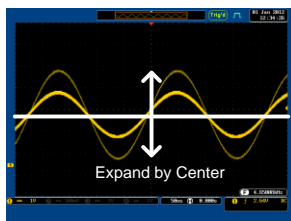

Select Probe Type

Background A signal probe can be set to voltage or current.

Panel Operation 1. Press the *Channel* key.

CH1

2. Press *Probe* from the bottom menu.

Probe
Voltage
1 X

3. Press the *Voltage/Current* soft-key to toggle between voltage and current.

Voltage
Current

Select Probe Attenuation Level

Background A signal probe has an attenuation switch to lower the original DUT signal level to the oscilloscope input range, if necessary. The probe attenuation selection adjusts the vertical scale so that the voltage level on the display reflects the real value on a DUT.

Panel Operation 1. Press the *Channel* key.

CH1

2. Press *Probe* from the bottom menu.

Probe
Voltage
1 X

3. Press *Attenuation* on the side menu and use the Variable knob to set the attenuation.



Alternatively, press *Set to 10X*.

Range 1mX ~1kX (1-2-5 step)



The attenuation factor adds no influence on the real signal. It just changes the voltage/current scale on the display.

Set the Deskew

Background The deskew function is used to compensate for the propagation delay between the oscilloscope and the probe.

- Panel Operation** 1. Press one of the *Channel* keys.

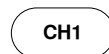

2. Press *Probe* from the bottom menu.

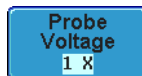

3. Press *Deskew* on the side menu and use the Variable knob to set the deskew time.



Alternatively, press *Set to 0s* to reset the deskew time.

Range -50ns~50ns, 10ps increments

4. Repeat the procedure for another channel if necessary.

Trigger

The trigger configures the conditions for when the GDS-2000A captures a waveform.

The following trigger overview only applies to the analog channels, for triggering details using the optional logic analyzer module, please see the GDS-2000A Options User Manual for details.

Trigger Type Overview

Edge The edge trigger is the simplest trigger type. An edge trigger triggers when the signal crosses an amplitude threshold with either a positive or negative slope.

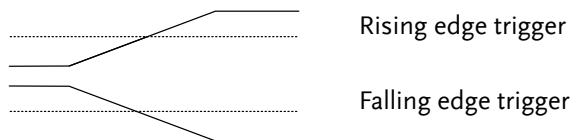

Delay The Delay trigger works in tandem with the edge trigger, by waiting for a specified time (duration) or number of events before the edge trigger starts. This method allows pinpointing a location in a long series of trigger events.

Note: when using the delay trigger, the edge trigger source can be any one of the channel inputs, the EXT input or the AC line.

Delay trigger example (by event)

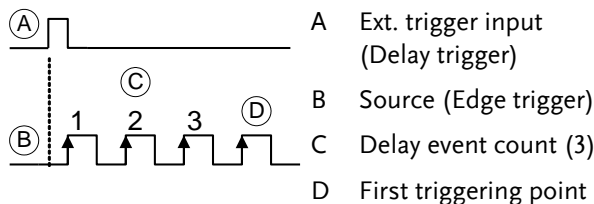

Delay trigger example (by time)

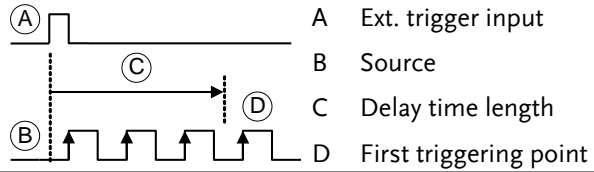

Pulse Width (Glitch)

Triggers when the pulse width (Glitch) of the signal is less than, equal, not equal or greater than a specified pulse width (Glitch).

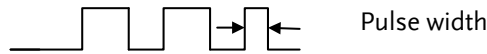

Video

Extracts a sync pulse from a video format signal, and triggers on a specific line or field.

Pulse and Runt

Triggers on a "runt". A runt is a pulse that passes a specified threshold but fails to pass a second threshold. Both positive and negative runts can be detected.

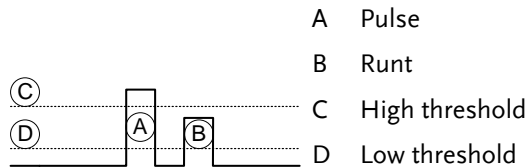

Rise and Fall (Slope)

Trigger on rising and or falling edges, below or over a specified rate. The threshold can also be specified.

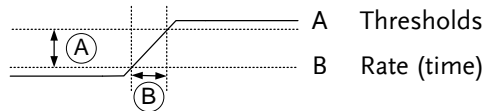

Timeout

Triggers when the signal stays high, low or either for a designated amount of time. The trigger level determines when a signal is high or low.

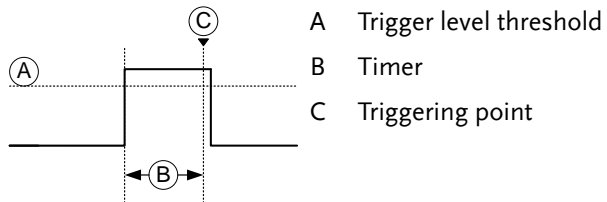

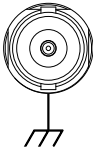

Trigger Parameter Overview

All the following parameters are common for all the trigger types unless stated otherwise.

Trigger Source	CH1 ~ 4	Channel 1 ~ 4 input signals	
	EXT	External trigger input signal	<p>EXT TRIG</p> 
	AC Line	AC mains signal	
	Alternate	Alternate between channel sources for the trigger source.	
	EXT Probe	Probe trigger source. Set the probe as either current or voltage.	

Trigger Mode	Auto (un-triggered roll)	The GDS-2000A generates an internal trigger if there is no trigger event, to make sure waveforms are constantly updated regardless of trigger events. Select this mode especially when viewing rolling waveforms at slower timebases.	
	Normal	The GDS-2000A acquires a waveform only when a trigger event occurs.	
	Single	The GDS-2000A acquires a waveform once when a trigger event occurs, then stops acquiring. Press the Single key to acquire a waveform again.	



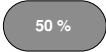

Coupling (Edge, Delay)	DC	DC coupling.
	AC	AC coupling. Blocks DC components from the trigger circuits.
	HF reject	High frequency filter above 100kHz
	LF reject	Low frequency filter below 5kHz
	Reject noise	DC coupling with low sensitivity to reject noise.

Slope (Edge, Delay, Rise & Fall)		Trigger on a rising edge.
		Trigger on a falling edge.
		Either. (either rising or falling edge) (Edge, Delay, Rise & Fall trigger type only)



Trigger Level (Edge, Delay)	Level	Adjusts the trigger manually using the Trigger LEVEL knob.	
	Set to TTL 1.4V	Sets the trigger level to 1.4V, suitable for triggering on TTL signals.	
	Set to ECL - 1.3V	Sets the trigger to -1.3V. This is suitable for ECL circuits.	
	Set to 50%	Sets the trigger level to 50% of the waveform amplitude.	

Holdoff	Holdoff	Sets the holdoff time.
	Set to Minimum	Set the holdoff time to the minimum.

Delay (Delay)	Time	Sets the delay time (10ns ~ 10s) between the trigger event and the real trigger timing.
------------------	------	---

	Event	Sets the number of events (1 ~ 65535) passed after the trigger event, until the real trigger timing.		
	Set to Minimum	Sets the source trigger to the minimum time.		
When (Pulse Width)	Sets the pulse width (10ns ~ 10s) and the triggering condition.			
	>	Longer than	=	Equal to
	<	Shorter than	≠	Not equal to
Threshold (Pulse Width)	Sets the amplitude threshold level for the pulse widths.			
	Threshold	-XXV ~ +XXV, user-set level		
	Set to TTL	1.4V		
	Set to ECL	-1.3V		
	Set to 50%	Sets the threshold to 50%		
Standard (Video)	NTSC	National Television System Committee		
	PAL	Phase Alternate by Line		
	SECAM	SEquential Couleur A Memoire		
Polarity (Pulse Width, Video)		Positive polarity (triggered on the high to low transition)		
		Negative polarity (triggered on the low to high transition)		
Polarity (Pulse Runt)		Positive polarity (positive runt)		
		Negative polarity (negative runt)		
		Either (either negative or positive runt)		
Trigger On	Selects the trigger point in the video signal.			

(Video)	Field	1 or 2 or all.
	Line	1~263 for NTSC 1~313 for PAL/SECAM

Threshold (Pulse Runt)		Sets the upper threshold limit.
		Sets the lower threshold limit.
	Set to TTL	1.4V
	Set to ECL	-1.3V

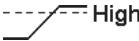
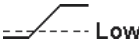
Threshold (Rise & Fall)		High Sets the High threshold.
		Low Sets the Low threshold.
	Set to TTL	1.4V
	Set to ECL	-1.3V

Trigger When (Timeout)	Stays High	Triggers when the input signal stays high for a designated amount of time.
	Stays Low	Triggers when the input signal stays low for a designated amount of time.
	Either	Triggers when the input signal stays high or low for a designated amount of time.

Timer (Timeout)	10nS~10.0S	Sets the amount of time that a signal must stay high or low for the timeout trigger.
--------------------	------------	--

Setup Holdoff Level

Background The holdoff function defines the waiting period before the GDS-2000A starts triggering again after a trigger point. The holdoff function ensures a stable display if there are a number of points in a periodic waveform that can be triggered. Holdoff applies to all the triggering types.

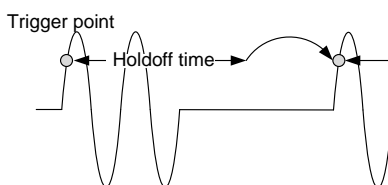

Panel Operation 1. Press the trigger *Menu* key.



2. To set the Holdoff time, press the *Holdoff* (or *Mode/Holdoff*) menu button on the bottom bezel.



3. Use the side menu to set the Holdoff time.



Range 10ns~10s

Pressing *Set to Minimum* sets the Holdoff time to the minimum, 10ns.





Note





Note: The holdoff function is automatically disabled when the waveform update mode is in roll mode (page132).

Setup Trigger Mode

Background The trigger mode can be set to Normal or Auto (untriggered roll). The triggering mode applies to all the trigger types. See page 132.

- Panel Operation**
1. Press the Trigger menu key. 
 2. Press *Mode* from the bottom menu to change the triggering mode. 
 3. Use the side panel to select *Auto* or *Normal* triggering modes.
Range Auto, Normal

Using the Edge Trigger

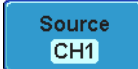
- Panel Operation**
1. Press the Trigger menu key. 
 2. Press *Type* from the lower bezel menu. 
 3. Select *Edge* from the side menu. The edge trigger indicator appears at the bottom of the display. 

From left: trigger source, slope, trigger level, coupling
 4. Press *Source* to change the trigger source. 

5. Use the side menu to select the trigger source type.

Range Channel 1 ~ 4 (Alternate On/Off),
EXT (Ext Probe: Volt/Current,
Attenuation: 1mX~1kX), AC Line

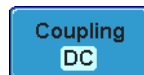
6. Press *Coupling* from the bottom bezel menu to select the trigger coupling or frequency filter settings.



7. Choose the coupling from the side menu.

Range DC, AC

8. Press *Reject* to toggle the rejection filter from the side menu.

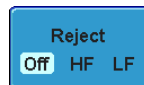

Range HF Reject, LF Reject, Off

9. Toggle *Noise Rejection* On or Off from the side menu.

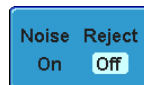

Range On, Off

10. From the bottom menu press *Slope* to toggle the slope type.



Range Rising edge, falling edge, either

11. To set the external trigger level, select *Level* from the bottom bezel menu.



12. Set the external trigger level using the side menu.

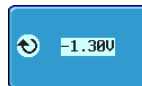

- Range 00.0V~ 5 screen divisions
- Set to TTL 1.4V
- Set to ECL -1.3V
- Set to 50%

Using Advanced Delay Trigger

Background The EXT trigger source is always used as the delay triggering source.

Panel Operation 1. Press the trigger *Menu* key.

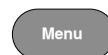

2. Press *Type* from the lower bezel menu.



3. Select *Delay* from the side menu. The delay + edge trigger indicator appears at the bottom of the display.



From left: delay trigger, delay source (external), delay coupling + edge source, edge slope, edge trigger level

4. To set the delay press *Delay* from the bottom bezel.

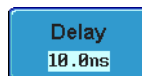

5. To Delay by Time (Duration), press *Time* from the side menu and set the delay time.



Range 10ns ~ 10s (by time)
Set to minimum

6. To Delay by Event, press *Event* from the side menu and set the number of events.

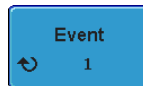

Range 1 ~ 65535 events
Set to Minimum

Using Pulse Width (Glitch) Trigger

- Panel Operation 1. Press the trigger *Menu* key.

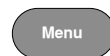

2. Press the *Type* key from the lower bezel menu.



3. Select *Pulse Width* from the side menu. The pulse width (glitch) trigger indicator appears at the bottom of the display.



From left: source, polarity, when, coupling

4. Press *Source* from the lower bezel.

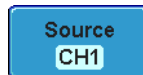

5. Use the side menu to select the pulse width (glitch) trigger source.
- Range Channel 1 ~ 4 (Alternate On/Off),
EXT (Ext Probe: Volt/Current,
Attenuation: 1mX~1kX), AC Line

6. Press *Polarity* to toggle the polarity type.



- Range Positive (high to low transition)
Negative (low to high transition)

7. Press *When* from the lower bezel.

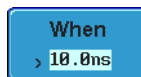

Then use the side menu to select the pulse width condition and width.

Condition > , < , = , ≠

Width 10ns ~ 10s

8. Press *Threshold* from the lower bezel to edit the pulse width threshold.



Use the side menu to set the threshold.

- Range -XXV~XXV
Set to TTL 1.4V
Set to ECL -1.3V
Set to 50%

Using Video Trigger

Panel Operation 1. Press the trigger *Menu* key.



2. Press the *Type* key from the lower bezel menu.



3. Select *Video* from the side menu.
The video trigger indicator appears at the bottom of the display.



From left: source, video standard, field, line, coupling

4. Press *Source* from the lower bezel.

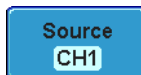

5. Use the side menu to select the video trigger source.

Range Channel 1 ~ 4

6. Press *Standard* on the bottom bezel.



Use the side menu to select the video standard.

Range NTSC, PAL, SECAM

7. Press *Trigger On* to edit the video field and line.



Use the side menu to select the field and line.

Field 1, 2, All

Video line NTSC: 1 ~ 262 (Even), 1 ~ 263 (Odd)
 PAL/SECAM: 1 ~ 312 (Even),
 1 ~ 313 (Odd)

8. Press *Polarity* to toggle the polarity type.



Range positive, negative

Pulse Runt trigger

- Panel Operation 1. Press the trigger *Menu* key.



2. Press the *Type* key from the lower bezel menu.



3. Select *Others* → *Pulse Runt* from the side menu. The Pulse and Runt indicator appears at the bottom of the display.

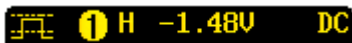
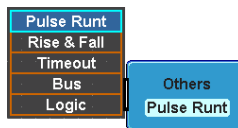

From left: Polarity, source, high/low threshold, threshold level, coupling

4. Press *Source* from the lower menu.

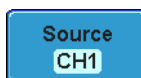

Use the side menu to select a source.

Range Channel 1 ~ 4

5. Press *Polarity* to toggle the polarity.



Range Rising edge, falling edge, either.

6. Press *When* from the lower menu.

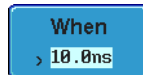

Then use the side menu to select the condition and width.

Condition > , < , = , ≠

Width 10ns ~ 10s

7. Press *Threshold* from the lower bezel to edit the threshold for the upper and lower threshold.

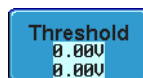

8. Use the side menu to set the upper threshold.

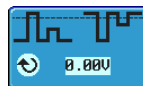

Range -XXV~XXV

Set to TTL 1.4V

Set to ECL -1.3V

9. Use the side menu to set the lower threshold.

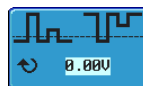

Range -XXV~XXV

Set to TTL 1.4V

Set to ECL -1.3V

Using Rise and Fall (Slope) Trigger

Panel Operation 1. Press the trigger *Menu* key.



2. Press the *Type* key from the lower bezel menu.



3. Select *Others* → *Rise and Fall* from the side menu. The Rise and Fall indicator appears at the bottom of the display.

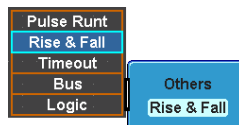

From left: Slope, source, high/low threshold, threshold level, coupling

4. Press *Source* from the lower menu.

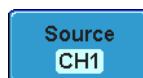

Use the side menu to select a source.

Range Channel 1 ~ 4

5. Press *Slope* from the bottom menu to toggle the slope.



Range Rising edge, falling edge, either

6. Press *When* from the lower menu.

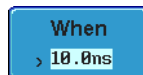

Then use the side menu to select the logic conditions and true or false status.

Condition > , < , = , ≠

Width 10ns ~ 10s

7. Press *Threshold* from the lower bezel to edit the High and Low threshold.

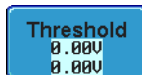

Range High: -XXV~XV
 Low: -XXV~XXV
 Set to TTL 1.4V
 Set to ECL -1.3V

Using the Timeout Trigger

- Panel Operation 1. Press the trigger *Menu* key.



2. Press the *Type* key from the lower bezel menu.



3. Select *Others* → *Timeout* from the side menu. The Timeout indicator appears at the bottom of the display.

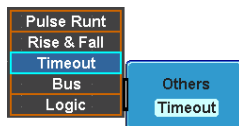

Timeout 1.40V DC

From left: Source, Trigger type, threshold level, coupling

4. Press *Source* from the lower menu.



Use the side menu to select a source.

Range Channel 1 ~ 4, D0~D15, EXT (Ext
 Probe: Volt/Current, Attenuation:
 1mX~1kX), AC Line

5. Press *Trigger When* from the lower menu.



Trigger
When
Stays High

Then use the side menu to select trigger conditions.

Condition Stays High, Stays Low, Either

6. Press *Level* from the lower bezel to set the trigger level.



Level
1.40V

Range -XXV~XXV

Set to TTL 1.4V

Set to ECL -1.3V

Set to 50%

7. Press *Timer* from the lower bezel to set the timer time.



Timer
398us

Range -10ns~10.0S

Search

The search feature can be used to search for events on both the analog and digital input channels. The events that can be searched for are similar to the events that are used for the trigger system. The only difference is that the search feature uses the measurement threshold levels rather than the trigger level to determine events.

Configuring Search Events

Background Similar to configuring the trigger system, the Search events must first be configured before they can be found.



Luckily the trigger system configuration settings can also be used for the search events. The types of searches are listed below. Please note that a full description of the events can be found in the Trigger section on page 144.

Display

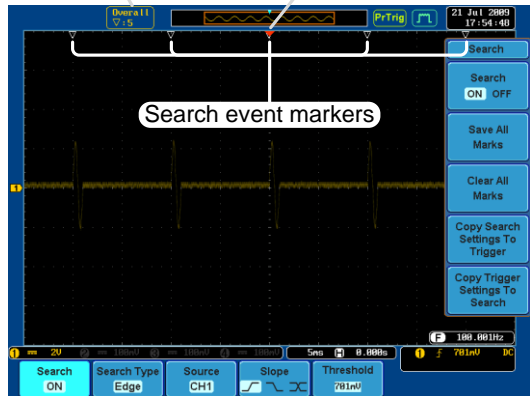
Number of search events Trigger point

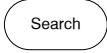

Search Event Types Edge, Pulse Width, Pulse Runt, Rise and Fall Times, Logic*, Bus*
 *Requires the Logic Analyzer option.

- Panel Operation
1. Press the *Search* menu key. 
 2. Press *Search* from the bottom menu and turn the Search function on. 
 3. Press *Search Type* from the bottom menu and select the type of search. The search events are configured in the same fashion as the trigger events. 

Please see the trigger configuration settings for details:

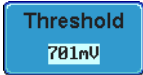
Event Types: Edge, Pulse Width, Pulse Runt, Rise/Fall Time, Logic*, Bus*
 *Requires the Logic Analyzer option.
 4. To set the threshold levels for the search events (instead of the trigger level that is used for trigger events), use the threshold soft-key from the bottom menu. 



Note

The search function can support up to 10,000 events, however only 1,000 events can be displayed on screen at once.

Copying Search Event To/From Trigger Events

Background As the trigger system and search feature have similar settings, their settings can be used interchangeably by using the Copy functions.

Interchangeable Settings Edge, Pulse Width, Pulse Runt, Rise and Fall Times, Logic, Bus

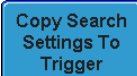
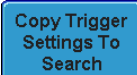
- Panel Operation**
1. Press *Search* from the lower bezel menu. 
 2. To copy settings of the selected search type to the trigger settings, select *Copy Search Settings to Trigger*. 
 3. To copy over the current trigger settings to the search settings, press *Copy Trigger Settings to Search*. 
-



Note

If the settings cannot be copied or if there are no trigger settings configured (so that you cannot copy from the trigger settings), then those particular options will not be available.

Search Event Navigation

Background When using the search feature, each event can be searched for according to the event settings.

- Operation**
1. Turn Search on and set the appropriate search type. 163

2. Search events are marked by hollow white triangles at the top of the graticule.
3. Use the search arrow keys to move between each search event.

Search events can be navigated in both stop and run mode.

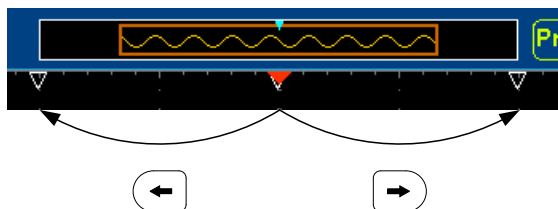

When using the arrow keys to navigate to each event, the “current event” will always be centered on the display.

Save Search Marks

Background The search events can be saved to the graticule display, allowing you to superimpose new search events. Search event are saved over the entire record length, with a maximum of 200 marks.

Save Marks

1. Press *Search* from the lower bezel menu.

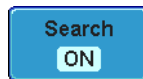

2. Press the *Save All Marks* soft-key.



3. The search event markers will become solid white triangles to indicate that they have been saved.



Clear All Marks	To clear all the saved marks, press Clear All Marks from the side menu.	
-----------------	---	---





Note

Each time the Save All Marks function is used, the previously saved marks will also be retained, unless cleared.

Setting/Clearing Single Search Events

Background	In addition to searching for search events based on Search Type settings, custom search marks can be created with the Set/Clear key.
------------	--

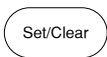
Set Search Event	<ol style="list-style-type: none"> <li data-bbox="381 675 995 782">1. Navigate to a point of interest using  POSITION  the horizontal position knob or some other method.  <li data-bbox="381 829 995 893">2. Press the <i>Set/Clear</i> key.  <li data-bbox="381 925 995 1160">3. A marker will be saved at the center of the display. <ul style="list-style-type: none"> <li data-bbox="420 1029 995 1160">• This marker can be navigated to/from in the same way that a normally saved search marker can.
------------------	---

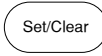
Clear Search Event	To clear a set search event, use the search arrows to navigate to the event of interest and press the Set/Clear key. 
--------------------	--

The marker will be deleted from the display.

System Info / Language / Clock

This section describes how to set the interface, beeper, language, time/date, and probe compensation signal.

Select Menu Language

Parameter	<p>The following is a list of the languages available by default. Language selection may differ according to the region.</p> <ul style="list-style-type: none"> • English • Chinese (simplified) • Japanese • French • Russian • Chinese (traditional) • Korean • Polish • Spanish • German
-----------	---

Panel Operation 1. Press the *Utility* key.



2. Select the language from the side menu.

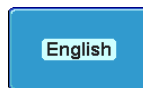

Range* English, Trad. Chinese, Simp. Chinese, Korean, Japanese, Polish, French, Spanish, Russian, German.

*Language selection may differ based on region.

View System Information

Panel Operation 1. Press the *Utility* key.



2. Press *System* from the lower menu.

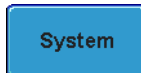

3. Press *System Info* from the side menu. A display panel will appear showing:

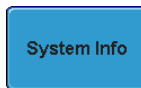





- Manufacturer name
- Model name
- Serial number
- Firmware version
- Manufacturer URL



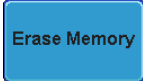

Erase Memory

Background The Erase Memory function will erase all internal waveforms, setup files and labels from internal memory.



Erased Items Waveform 1~20, Setting memory 1~20, Reference 1~4, Labels

- Panel Operation
1. Press the *Utility* key. 
 2. Press *System* from the lower menu. 
 3. Press *Erase Memory* from the side menu. 
- A message will prompt you to press Erase Memory again to confirm the process.
4. Press *Erase Memory* again. 

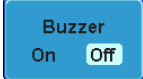
Turn the Buzzer On/Off

- Panel Operation
1. Press the *Utility* key. 
 2. Press *System* from the lower menu. 
 3. Press *Buzzer* to toggle the buzzer sound on or off. 

Set Date and Time

- Panel Operation/
Parameter
1. Press the *Utility* key. 
 2. Press *Date & Time* on the lower menu. 

- Set the *Year, Month, Day, Hour* and *Minute* from the side menu.

Year 2000 ~ 2037

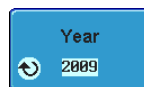

Month 1 ~ 12

Day 1 ~ 31

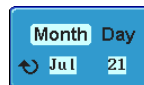

Hour 1~23

Minute 0~59

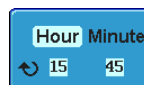

- Press *Save Now* from the side menu to save the date and time.



- Make sure the date/time setting is correctly reflected at the top of the display.

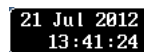

Demo Outputs

Background

The Demo outputs on the front panel are multi-function outputs that can be configured as a probe compensation output, a trigger output signal or to output a number of waveforms for demonstration purposes.

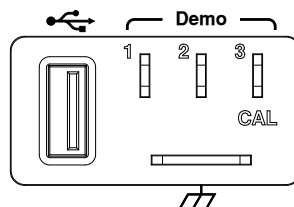

Waveforms Outputs	Mode	Demo Outputs
	Analog	Demo 1 Trigger Output OR Pulse Signal: Burst frequency: 100kHz, Burst duration: 500uS (50 pulses) Burst Period: 1mS
		Demo 2 FM: 100kHz~1MHz
		Demo 3 Probe Compensation output, 1kHz~200kHz, Duty Cycle 5%~95%
	UART	Demo 1 Tx: 115200 baud, 8 data bits, no stop bit
		Demo 2 Rx, 115200 baud, 8 data bits, no stop bit
		Demo 3 Probe Compensation output, 1kHz~200kHz, Duty Cycle 5%~95%
	¹² C	Demo 1 SCLK, 20kHz
		Demo 2 SDA, ID=0x52
		Demo 3 Probe Compensation output, 1kHz~200kHz, Duty Cycle 5%~95%
SPI	Demo 1 SCLK, 50kHz	
	Demo 2 SS	
	Demo 3 MOSI	

Panel Operation/ Parameter 1. Press the *Utility* key.



2. Press *Demo Output* on the lower menu.

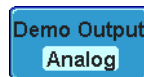

3. Press *Demo Mode* from the side menu and select the mode for the Demo outputs. The actual output waveform for each demo output is listed in the side menu.

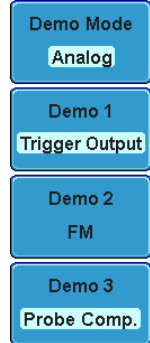

Trigger Output Usage:

To use the DEMO 1 Trigger Output signal, an input signal should first be connected to one of the input channels (CH1, 2, 3 or 4), otherwise no Trigger Output signal will be shown.

PTIONAL SOFTWARE

and APPS.

Applications	175
Overview	175
Running Applications	175
Uninstalling Applications	176
Using Go-NoGo	177
Optional Software	182
Activating Optional Software	182
Running Optional Software	182
Uninstalling Optional Software	183

Applications

Overview

Background The APP. function allows different applications to be run. Applications can be downloaded from the GW Instek website.

Included Applications **Go/No-Go** The Go/No-Go application can be used to set threshold boundaries for input signals. Go/No-Go checks if a waveform fits inside a user-specified maximum and minimum amplitude boundary (template).

Running Applications

Background The APP. function can host a number of different applications that can be downloaded from the GW Instek website.

Panel Operation 1. Press the *Test* key.

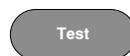

2. Press *APP.* from the bottom menu.



3. Scroll through each application using the *Variable* knob.



4. Select an application by pressing the *Select* key *twice*.



Uninstalling Applications

Background Any app can be easily uninstalled using the *Uninstall* function.

- Panel Operation** 1. Press the *Test* key.



2. Press *APP.* from the bottom menu.



3. Scroll through each application using the Variable knob.



4. When the desired application is highlighted, press *Uninstall* to begin the uninstallation. Press again to confirm.

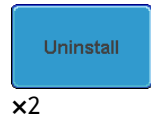

Using Go-NoGo

Background

The Go-NoGo test checks if a waveform fits inside a user-specified maximum and minimum boundary. Boundary templates are automatically created from a source channel. Boundary tolerances and violation conditions can be set.

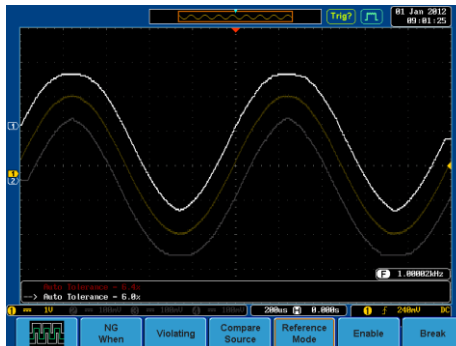

Choose the Go_NoGo application from the APP. menu. See page 175.

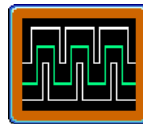

Set Go-NoGo Conditions

Select the Go-NoGo conditions (NG When) and actions when a Go-NoGo condition has been met (Violating).

1. Press *NG When* from the bottom menu and select the NoGo conditions:

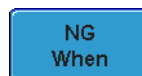

Enters: Sets the NoGo condition to when the input signal stays within the limit boundary.

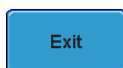

Exits: Sets the NoGo condition to when the input signal exceeds the limit boundary.

2. Press *Go Back* to return to the previous menu.



Set Go-NoGo Actions

1. Press *Violating* to set what action to perform when a signal is violating the Go-NoGo conditions.



The waveform stops when the conditions are violated.





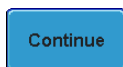







The waveform stops and a beep will be output when the conditions are violated.



Ignore violations and continue to monitor the signal.

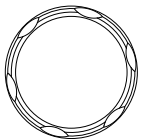

Output a beep when a violation occurs, but continue to monitor the signal.

	2. Press <i>Go Back</i> to return to the previous menu.	
Set Go-NoGo Source	1. Press <i>Compare Source</i> from the bottom menu to set the Go-NoGo boundary source.	
	 Sets CH1 as the source.	
	 Sets CH2 as the source.	
	 Sets CH3 as the source.	
	 Sets CH4 as the source.	
	2. Press <i>Go Back</i> to return to the previous menu.	
Set Boundary Tolerance	1. To set the Go-NoGo boundary tolerance, press <i>Reference Mode</i> .	
Auto Tolerance	2. To set the boundary tolerance as a percentage offset from the source waveform, press <i>Auto Tolerance</i> and use the Variable knob.	 VARIABLE
		
	Offset 0.4% ~ 40% (.4% steps)	
Maximum and Minimum Position	3. To manually set the template tolerance, press <i>Minimum Position</i> or <i>Maximum Position</i> and use the Variable knob to set the absolute minimum or maximum position.	
		or 

Range Voltage division range

Save Boundary Template

4. Press *Save Operation* to save the tolerance boundaries.



5. The Maximum Position tolerance will be saved to reference waveform R1, and the Minimum Position tolerance to R2.

6. Press *Go Back* to return to the previous menu.



Note

It may be necessary to save a reference waveform to R1 and R2 before the tolerance for Maximum and Minimum Position can be created. This can be done by first creating and saving the Auto Tolerance boundary.

Start Go-NoGo

Press *Enable* to start the Go-NoGo test. The Enable button will change to Disable. Pressing *Disable* will stop the Go-NoGo test and toggle the button back to Enable.

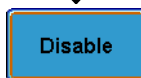

If the Violating setting was set to Stop or Stop Beep, press *Enable* to restart the test after it has stopped.

Results

When Go-NoGo is running, the pass/fail ratio is displayed in the bottom left-hand corner. The first digit represents the number of failed tests, and the right hand digit represents the number of tests.

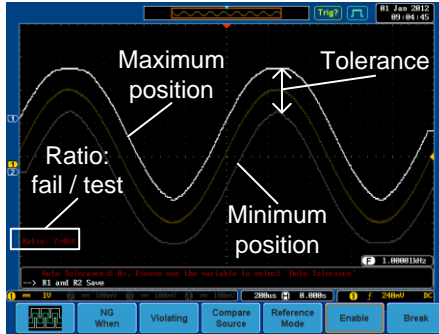

Exit the Application

To exit the application, press *Break*.

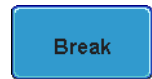

Using the Go-NoGo Output

To output the Go-NoGo results to an external device, the Go-NoGo rear panel terminal (open collector) can be used. The Go-NoGo terminal will output a positive pulse each time a NoGo violation has occurred for a minimum of 500us. The voltage of the pulse depends on the external pull-up voltage.



Timing Diagram

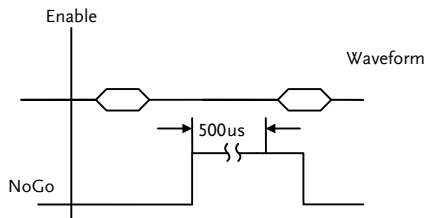

Circuit Diagram

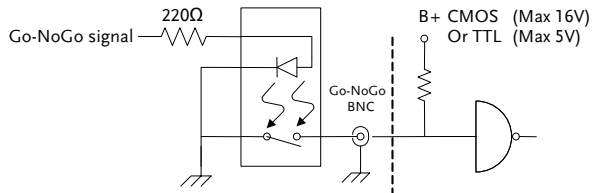

Optional Software

Activating Optional Software

Background The GDS-2000A has optional software packages to expand the functionality of the standard GDS-2000A. An activation key is required to activate any optional software. A different activation key is required for each optional software package.

For the latest files and information regarding the optional software packages, see the GW Instek website: www.gwinstek.com or contact your nearest distributor.

Install Optional Hardware Modules Please see page 30 for details on how to install optional hardware modules if the option software also requires option hardware modules.

Install Optional Software Modules Please see page 31 for details on how to install the optional software packages.

Running Optional Software

Background Most of the optional software functions can be accessed via the Option key, located beside the bottom menu keys.

Panel Operation 1. Press the *Option* key.

Option



2. Select the relevant option from the bottom menu.

If an option is not installed, it will be grayed-out.

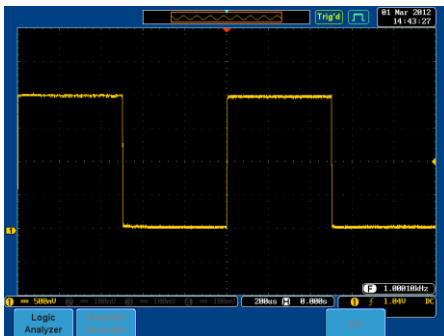

3. Please see the GDS-2000A Options User Manual for how to use the optional software functions.

Uninstalling Optional Software

Background Optional software packages such can be uninstalled from the system menu.

- Panel Operation**
1. Press the *Utility* key.
 2. Press *System* from the bottom menu.
 3. Press more *1 of 2* from the side menu.

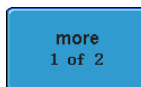
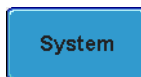

4. Press *Option Uninstall* on the side menu.

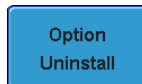

5. Select the optional software packages that you wish to uninstall from the side menu.

6. Use the *Up* and *Down* arrows on the side menu to select an option to uninstall.



7. Press *Uninstall* to uninstall the option.



SAVE/RECALL

File Format/Utility	186
Image File Format.....	186
Waveform File Format.....	186
Spreadsheet File Format.....	187
Setup File Format.....	189
Create/Edit Labels	191
Save	195
File Type/Source/Destination.....	195
Save Image	196
Save Waveform	198
Save Setup	200
Recall	202
File Type/Source/Destination.....	202
Recall Default Panel Setting.....	202
Recall Waveform.....	205
Recall Setup.....	206
Reference Waveforms	209
Recall and Display Reference Waveforms	209

File Format/Utility

Image File Format

Format	DSxxxx.bmp or DSxxxx.png
Contents	The display image is 800 by 600 pixels. The background color can be inverted (Ink saver function). Each image file is saved to the current file path as a bitmap or PNG file.

Waveform File Format

Format	DSxxxx.lsf, CH1~CH4.lsf	
	The LSF file format efficiently stores waveforms. This is the file format used for storing and recalling all waveforms that are be used with the GDS-2000A series.	
Waveform Type	CH1 ~ 4	Input channel signal
	REF	Reference waveform
	Math	Math operation result (page 93)
	D0~D15	Digital channels* *For the logic analyzer options only.
Storage Location	Wave1 ~ Wave20	Waveform files stored to the internal memory. Stored waveforms can be copied to Ref. 1 ~ 4 to be viewed on the display. (W1 ~ W20 waveforms cannot be directly recalled on the display).

Ref 1~4 Reference waveforms stored in the internal memory, separate from W1 ~ W20. Reference waveforms (Ref 1 ~ 4) can be displayed directly onto the display with amplitude and frequency information. Ref 1~4 are useful for reference purposes. Other waveforms (LSF and W1~20) must be recalled to R1~4 before being displayed.

Contents: The waveform data can be used for detailed
Waveform Data analysis. It consists of the horizontal and vertical data used by the waveform.

Spreadsheet File Format

Format DSxxxx.csv (Comma-separated values format, can be opened in spreadsheet applications such as Microsoft Excel).

CSV-formatted files can be stored in either a short-memory format or a long-memory format: Detail CSV, Fast CSV, LM Detail CSV and LM Fast CSV.

Detail CSV will record both the horizontal and vertical sample points of the waveform. All the points are recorded in scientific notation for analog data. CSV data will only record 5000 points of data.

Fast CSV will only record the vertical amplitude of the sample points. Fast CSV also contains data that enables the horizontal data points to be reconstructed, such as trigger position, etc. Fast CSV will only record 5000 points of data. Data is recorded as integers.

LM Detail CSV is similar to CSV but covers the entire long-memory (See page 109 for information on the record length). All points are recorded in scientific notation for analog data.

LM Fast CSV is similar to Fast CSV but covers the

entire long memory length (See page 109 for information on the record length). All points are recorded as integers.

Note, however, that only fast CSV can be recalled to the internal memory. Detailed CSV, LM Fast CSV and LM Detailed CSV cannot be recalled.

Waveform Type	CH1 ~ 4	Input channel signal
	Ref1~4	Reference waveform
	Math	Math operation result (page 93)
	D0~D15	Digital channels
	All Displayed	All the waveforms on the display.

Contents: Detail CSV & LM Detail CSV	<p>Detail CSV waveform data contains channel information such as vertical and horizontal position of a signal for 5000 points.</p> <p>The following information is included in Detail CSV, where applicable:</p> <ul style="list-style-type: none"> • Format (scope type) • Trigger Level • Label • Vertical units • Vertical position • Horizontal scale • Horizontal mode • Firmware • Mode • Horizontal data • Memory length • Source • Probe ratio • Vertical scale • Horizontal units • Horizontal position • Sampling period • Time • Vertical data
---	--

Contents: Fast CSV	<p>The following information is included in the Fast CSV waveform files, where applicable:</p>
-----------------------	--

- | | | |
|------------------|--|--|
| &
LM Fast CSV | <ul style="list-style-type: none"> • Format (scope type) • IntpDistance (input trigger distance) • Trigger level • Vertical units • Vertical units extend div • Probe type • Vertical scale • Horizontal units • Horizontal position • SincET mode (sampling mode) • Horizontal old scale • Firmware • Mode | <ul style="list-style-type: none"> • Memory length • Trigger address • Source • Vertical units div • Label • Probe ratio • Vertical position • Horizontal scale • Horizontal mode • Sampling period • Horizontal old position • Time • Raw vertical waveform data |
|------------------|--|--|

Setup File Format

Format	DSxxxx.set (proprietary format) The setup file saves or recalls the following settings.
--------	--

- | | | |
|----------|---|--|
| Contents | Acquire <ul style="list-style-type: none"> • Mode • Sample rate • Digital Filter | <ul style="list-style-type: none"> • XY • Sample mode • Record Length |
|----------|---|--|

Display	<ul style="list-style-type: none"> • Mode • Persistence • Waveform intensity 	<ul style="list-style-type: none"> • Graticule intensity • Waveform visuals • Graticule
Channel	<ul style="list-style-type: none"> • Scale • Channel • Coupling • Impedance • Invert • Bandwidth 	<ul style="list-style-type: none"> • Expand • Position • Probe • Probe attenuation • Deskew
Cursor	<ul style="list-style-type: none"> • Horizontal cursor • H Unit 	<ul style="list-style-type: none"> • Vertical cursor • V Unit
Measure	<ul style="list-style-type: none"> • Source • Gating • Statistics 	<ul style="list-style-type: none"> • Display • High-Low
Horizontal	<ul style="list-style-type: none"> • Scale 	
Math	<ul style="list-style-type: none"> • Source1 • Operator • Source2 	<ul style="list-style-type: none"> • Position • Unit/Div • Math Off
Trigger	<ul style="list-style-type: none"> • Type • Source • Coupling • Alternate • Rejection 	<ul style="list-style-type: none"> • Noise Rejection • Slope • Level • Mode • Holdoff
Utility	<ul style="list-style-type: none"> • Language • Hardcopy key • File Format 	<ul style="list-style-type: none"> • Ink Saver • Buzzer • Assign Save

- Save/recall
- Image file format
- Data file format

Create/Edit Labels

Overview Reference files, Setup files and the analog input channels can have individual file labels set.

For the analog channels and reference waveforms, the file label can be displayed next to the channel/reference indicator.

The file labels are also obviously used to identify reference files, setup files or channels when saving or recalling waveforms and setups.

Example

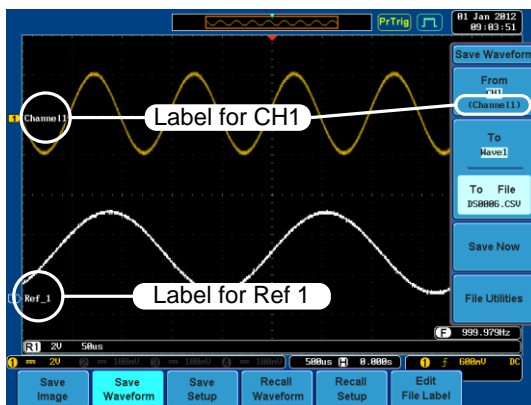

In the example above, the file label for channel 1 is displayed next to the channel indicator and is also displayed in the *Save Waveform* menu. The Ref_1 file label is shown next to the reference indicator.



Note

When using the optional Logic Analyzer, labels can also be set for the digital channels. Please see the GDS-2000A Options User Manual for details. The labels for digital channels cannot be edited from the Save/Recall menu.

Panel Operation

1. Press the *Save/Recall* key from the front panel.



2. Press *Edit File Label* from the bottom menu.



3. Press *Label For* and select the item that you want to create the label for.



Label For CH1~CH4, Ref1~4, Set1~20

4. To choose a preset label, Press *User Preset* from the side menu and choose a label.



Labels ACK, AD0, ANALOG, BIT, CAS, CLK, CLOCK, CLR, COUNT, DATA, DTACK, ENABLE, HALT, INT, IN, IRQ, LATCH, LOAD, NMI

Edit Label

1. Press *Edit Character* to edit the current label.

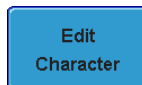

- The Edit Label window appears.



- Use the Variable knob to highlight a character.

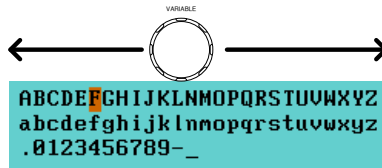

Press *Enter Character* to select a number or letter.



Press *Back Space* to delete a character.



Press *Editing Completed* to save the label and return to the previous menu.

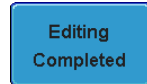

To cancel the editing the label and return to the previous menu, press *Cancel*.



Display Label

To display the currently selected file label on the screen next to its respective indicator, toggle *Label Display* to On.



Conversely, if you want to remove the currently selected file label from the display, toggle *Label Display* to Off.

Save

File Type/Source/Destination

Item	Source	Destination
Panel Setup (DSxxxx.set)	<ul style="list-style-type: none"> • Front panel settings 	<ul style="list-style-type: none"> • Internal memory: Set1 ~ Set20 • File system: Disk, USB
Waveform Data (DSxxxx.csv) (DSxxxx.lsf) (CH1~CH4.lsf, Ref1~Ref4.lsf, Math.lsf)* ALLxxxx.csv	<ul style="list-style-type: none"> • Channel 1 ~ 4 • Math operation result • Reference waveform Ref1~4 • D0~D15¹ • All displayed waveforms 	<ul style="list-style-type: none"> • Internal memory: Reference waveform Ref1~4, Wave1 ~ Wave20 • File system: Disk, USB
Display Image (DSxxxx.bmp/png) (Axxx1.bmp/png)**	<ul style="list-style-type: none"> • Display image 	<ul style="list-style-type: none"> • File system: Disk, USB

*Stored in ALLXXX directories when All Displayed waveforms are saved.

**Stored in ALLXXX directories when the Hardcopy key is assigned to save Waveform, Setup or All.

¹Digital channels. Only applicable with the Logic Analyzer option.

Save Image

Images can be saved either using the Save/Recall key or by using the Hardcopy key. To save images using the Hardcopy key, see the hardcopy section on page 218.

- Panel Operation
1. To save to USB, connect a USB drive to the front or rear panel USB port. If a USB drive is not connected, images will be saved to the internal memory.

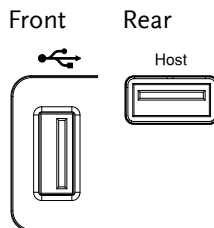

Note

Only one host connection, front or rear, is allowed at a time.
 The USB Device port on the rear panel cannot be used concurrently with the USB Host port on the rear panel.

Operation

2. Press the *Save/Recall* key from the front panel.



3. Press *Save Image* from the bottom menu.



4. Press *File Format* to choose PNG or BMP file types.



Range DSxxxx.bmp, DSxxxx.png

5. Press *Ink Saver* to toggle Ink Saver On or Off.

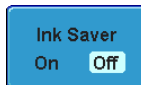

Ink Saver On

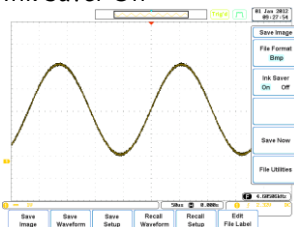

Ink Saver Off

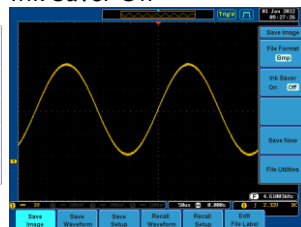

6. Press *Save Now* from the side menu to save the display as an image file.

Save NowImage saved to USB :/DS0197.BMP.

Note

The file will not be saved if the power is turned off or the USB drive is taken out before the message ends.

USB File Utility

To edit the USB flash drive contents (create/ delete/ rename files and folders) or to edit the default file path, press *File Utilities* from the side menu. See page 211 for details.

File Utilities

Save Waveform

- Panel Operation
- To save to an external USB flash drive, connect the drive to the front or rear panel USB port. If a USB drive is not connected, files will be saved to the internal memory.

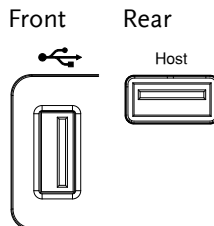

Note

Only one host connection, front or rear, is allowed at a time.
 The USB Device port on the rear panel cannot be used concurrently with the USB Host port on the rear panel.

- Press the *Save/Recall* key from the front panel.



- Press *Save Waveform* from the bottom menu.



- Choose the *From* waveform on the side menu.



Source CH1~4, Math, Ref1~4,
 D0~D15*, All Displayed

* digital channels only

- Press *To* (internal memory) or *To File* and choose a destination to save.



To Ref1~4, Wave1~20

To File Format: LSF, Detail CSV, Fast CSV, LM Detail CSV, LM Fast CSV

6. Press *Save Now* to confirm saving. When completed, a message appears at the bottom of the display.

A blue rectangular button with rounded corners and a thin black border, containing the text "Save Now" in white.An orange rectangular message box with a black border, containing the text "Waveform saved to USB :/DS0001.CSV." in black.

Note

The file will not be saved if the power is turned off or the USB drive is taken out before the message ends.

USB File Utility

To edit USB flash drive contents (create/ delete/ rename files and folders), press *File Utilities*. For details, see page 211.

A blue rectangular button with rounded corners and a thin black border, containing the text "File Utilities" in white.

Save Setup

- Panel Operation
- (For saving to an external USB flash drive) Connect the drive to the front or rear panel USB port. If a USB drive is not connected, files will be saved to the internal memory.

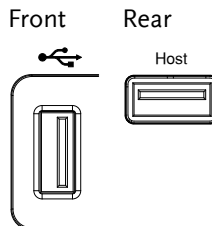

Note

Only one host connection, front or rear, is allowed at a time.
 The USB Device port on the rear panel cannot be used concurrently with the USB Host port on the rear panel.

- Press the *Save/Recall* key from the front panel.
- Press *Save Setup* from the bottom menu.
- Press *To* (internal memory) or *To File* and choose a destination to save.



To Set1~Set20
 To File DSxxxx.set

5. Press *Save Now* to confirm saving. When completed, a message appears at the bottom of the display.

A blue rectangular button with rounded corners containing the text "Save Now" in white.An orange rectangular message box with a black border and rounded corners, containing the text "Setup saved to USB :/DS0001.SET." in black.

Note

The file will not be saved if the power is turned off or the USB drive is taken out before the message ends.

USB File Utility To edit USB flash drive contents (create/ delete/ rename files and folders) or to set the file path, press *File Utilities*. For details, see 211.

A blue rectangular button with rounded corners containing the text "File Utilities" in white.

Edit Label To edit labels for Setup files, press *Edit Label*. For more details on editing labels, see page 191.

A blue rectangular button with rounded corners containing the text "Edit Label" in white.

Recall

File Type/Source/Destination

Item	Source	Destination
Default Panel Setup	<ul style="list-style-type: none"> Factory installed setting 	<ul style="list-style-type: none"> Current front panel
Reference Waveform	<ul style="list-style-type: none"> Internal memory: Ref1~4 	<ul style="list-style-type: none"> Current front panel
Panel Setup (DSxxxx.set)	<ul style="list-style-type: none"> Internal memory: S1 ~ S20 File system: Disk, USB 	<ul style="list-style-type: none"> Current front panel
Waveform Data (DSxxxx.lsf, DSxxxx.csv**, (CH1~CH4.lsf, Ref1~Ref4.lsf, Math.lsf)*	<ul style="list-style-type: none"> Internal memory: Wave 1 ~ Wave20 File system: Disk, USB 	<ul style="list-style-type: none"> Reference waveform 1 ~ 4

*Recalled from ALLXXX directories. Note that Allxxxx.csv cannot be recalled to the oscilloscope.

**Detail CSV, LM Detail CSV and LM Fast CSV files cannot be recalled to the oscilloscope.

Recall Default Panel Setting

Panel Operation 1. Press the *Default* key.



2. The screen will update with the default panel settings.

Setting Contents	The following is the default (factory) setting contents.	
Acquire	Mode: Sample Sample mode: Sinc Digital filter: Off	XY: OFF Sample rate: 2GSPS Record Length: Auto
Display	Mode: Vector Waveform intensity: 50% Waveform visuals: Gray	Persistence: 16ms Graticule intensity: 50% Graticule: full 
Channel	Scale: 100mV/Div Coupling: DC Invert: Off Expand: By ground Probe: voltage Deskew: 0s	CH1: On Impedance: 1MΩ Bandwidth: full Position: 0.00V Probe attenuation: 1x
Cursor	Horizontal cursor: Off H Unit: S	Vertical Cursor: Off V Unit: Base
Measure	Source 1: CH1 Gating: Off High-Low: Auto Mean & Std: 2	Source 2: CH2 Display: Off Statistics: Off
Horizontal	Scale: 10us/Div	
Math	Source1: CH1 Source2: CH2 Unit/Div: 200mV	Operator: + Position: 0.00 Div Math Off
Test	App: Go-NoGo	
Trigger	Type: Edge Coupling: DC	Source: CH1 Alternate: Off

	Rejection: Off	Noise Rejection: Off
	Slope: rising	Level: 0.00V
	Mode: Auto	Holdoff: 10.0ns
Utility	Language: English	Hardcopy key: Save
	Ink Saver: Off	File Format: BMP
	Assign Save To: Image	Buzzer: Off
Save / Recall	Image file format: Bmp	Data file format: LSF
Search	Search: Off	
Segments	Segments: Off	

Recall Waveform

- Panel Operation
1. For recalling from an external USB flash drive, connect the drive to the front or rear panel USB port.

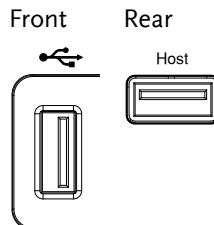

Only one host connection, front or rear, is allowed at a time.

The USB Device port on the rear panel cannot be used concurrently with the USB Host port on the rear panel.

2. The waveform must be stored in advance. See page 198 for waveform store details.

3. Press the *Save/Recall* key.



4. Press *Recall Waveform* from the bottom menu. The Recall menu appears.

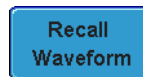

5. Press *From* (internal memory) or *From File* and choose a source to recall from.

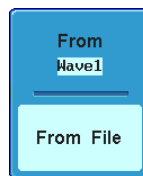

From Wave1~20

From File* File format: Lsf, Fast Csv

*Only files in the current file path will be available, this includes files saved in the ALLXXX directories.

Allxxxx.csv files cannot be recalled to the oscilloscope.

Only the “fast CSV” files can be recalled to the oscilloscope.

6. Press *To* and select the reference waveform to recall to.



To Ref1~4

7. Press *Recall Now* to recall the waveform.

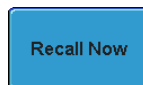

USB File Utility

To edit USB flash drive contents (create/ delete/ rename files and folders) or to set the file path, press *File Utilities*. For details, see page 211.

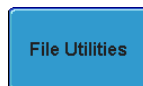

Recall Setup

Panel Operation

1. (For recalling from an external USB flash drive) Connect the drive to the front or rear panel USB port.

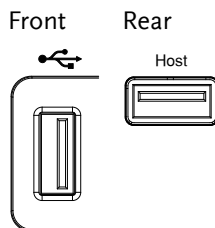



Note

Only one host connection, front or rear, is allowed at a time.

The USB Device port on the rear panel cannot be used concurrently with the USB Host port on the rear panel.

2. Press the *Save/Recall* key.

3. Press *Recall Setup* from the bottom menu.

4. Press *From* (internal memory) or *From File* and choose a source to recall from.

From Set1~20

From File DSxxxx.set (USB, Disk)*

* Only files in the current file path will be available.

5. Press *Recall Now* to confirm recalling. When completed, a message appears at the bottom of the display.



Note

The file will not be recalled if the power is turned off or the USB drive is taken out before the message appears.

USB File Utility

To edit USB flash drive contents (create/ delete/ rename files and folders) or to set the file path, press *File Utilities*. For details, see page 211.

Edit Label

To edit labels for Setup files, press *Edit label*. For more details on editing labels, see page 191.



Reference Waveforms

Recall and Display Reference Waveforms

Panel Operation A reference waveform must be stored in advance. See page 198 to store waveforms as reference waveforms.

1. Press the *REF* key on the front panel.



2. Pressing *R1~R4* repeatedly will toggle the corresponding reference waveform OFF/ON.

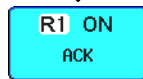

Turning *R1~R4* ON will open the corresponding reference menu.

3. If a reference waveform is ON but not active, its reference menu can be opened by pressing the corresponding *R1~R4* key from the bottom menu.

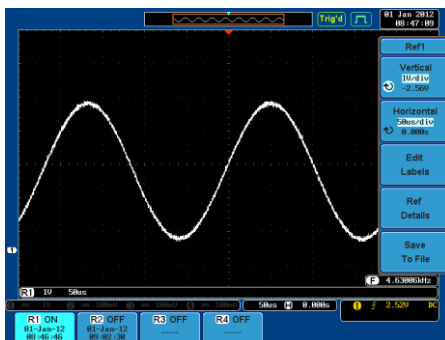
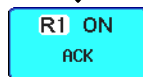
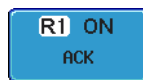

Vertical Navigation Press *Vertical* repeatedly from the side menu to choose to edit the vertical position or Unit/Div. Use the Variable knob to edit the values.



Horizontal Navigation Press *Horizontal* repeatedly from the side menu to choose to edit the Time/Div or the horizontal position. Use the Variable knob to edit the value.

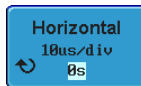

View Reference Waveform Details Pressing *RefDetails* will display the reference waveform details.



Details: Sample Rate, Record Length, Date

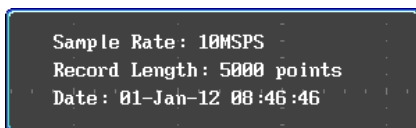

Edit Labels To edit labels for Setup files, press *Edit Labels*. For more details on editing labels, see page 191.



Save Reference Waveforms To save reference waveforms, press *Save to File*. For more details on saving waveforms, see page 198.



FILE UTILITIES

The file utilities are used each time files need to be saved to internal or external memory. The file utilities can create directories, delete directories, rename files as well as copy files from internal memory to USB. The File Utilities menu also sets the file path for saving and recalling files from the Save/Recall menu.

File Navigation	212
Create Folder	214
Rename File	215
Delete File	216
Copy File to USB	217

File Navigation

The File Utilities menu can be used to choose files or to set the file path for saving/recalling files.

File System

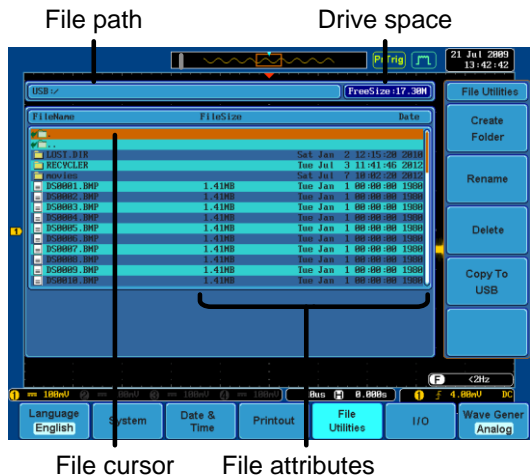

Panel Operation

1. Press the *Utility* key.
2. Press *File Utilities* from the bottom menu.



- The file system appears.



- Use the *Variable* knob to move the file cursor up and down.

Use the *Select* key to choose a file or directory or to set the file path.



- When a USB flash drive is used, the file path is remembered each time the USB flash drive is used. This saves you the hassle of setting the USB file path each time the USB flash drive is inserted into the scope.

Create Folder

Panel Operation 1. Press the *Utility* key.



2. Press *File Utilities* from the bottom menu.



3. Use the Variable knob and select key to navigate the file system.

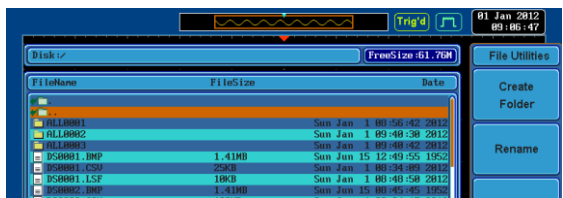

Create Folder 4. Press *Create Folder* to make a new directory at the selected location.

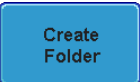

5. Use the *Variable* knob to highlight a character.



Press *Enter Character* to select a number or letter.



Press *Back Space* to delete a character.



6. Press *Editing completed* to create the folder name.



Cancel

- Press *Cancel* to cancel the operation.

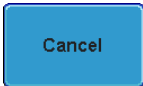

Rename File

Panel Operation

1. Press the Utility key.



2. Press *File Utilities* from the bottom menu.



3. Use the Variable knob and select key to choose a file to rename.

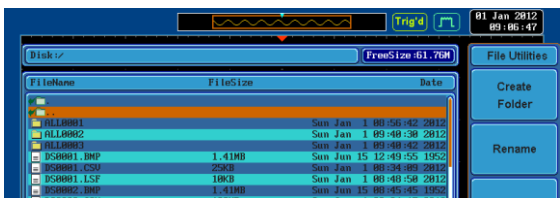

4. Press *Rename* when a file is chosen.



5. Use the *Variable* knob to highlight a character.



Press *Enter Character* select a number or letter.

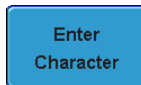

Press *Back Space* to delete a character.



6. Press *Editing completed* to rename the folder or file.

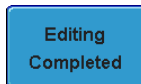

Delete File

- Panel Operation 1. Press the *Utility* key.

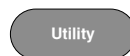

2. Press *File Utilities* from the bottom menu.



3. Use the Variable knob and select key to navigate the file system to choose a file.



4. Press *Delete* to delete the selected file.



5. Press *Delete* again to confirm the deletion.

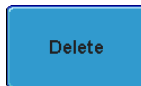

Copy File to USB

- Panel Operation 1. Connect a USB drive to the front or rear panel USB port. .

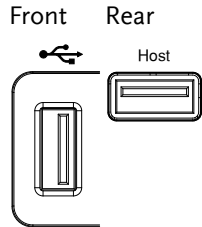

Note

Only one host connection, front or rear, is allowed at a time.
The USB Device port on the rear panel cannot be used concurrently with the USB Host port on the rear panel.

- Panel Operation 2. Press the *Utility* key.



3. Press *File Utilities* from the bottom menu.



4. Use the Variable knob and select key to navigate the file system to choose a file from internal memory.

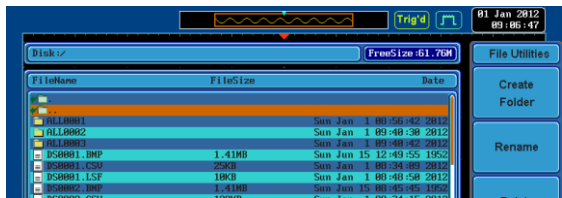

5. Press *Copy to USB* to copy the selected file to the USB drive.



Note

If the same file name already exists on the USB drive, it will be copied over.

HARDCOPY KEY

The Hardcopy key is used as quick-save or quick-print key. The Hardcopy key can be assigned either to printout screenshots or to save files.

When assigned to “Print” the screen image can be printed to a PictBridge compatible printer using the USB device port. To reduce the amount of printer ink used for each print, images can be printed using the Ink Saver function.

When assigned to “Save”, pressing the Hardcopy key can be used to save a screen shot, a waveform, or the current setup, depending on the configuration.

Printer I/O Configuration

- Panel Operation
1. Connect a PictBridge printer to the USB device port on the rear panel.

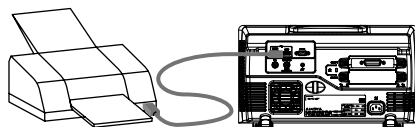

Note

The USB Device port on the rear panel cannot be used concurrently with the USB Host port on the rear panel.

2. Press the *Utility* key.

A grey, rounded rectangular button with the word "Utility" written in white text.

3. Press *I/O* from the bottom menu.

A blue rectangular button with the text "I/O" written in white text.

4. Press *USB Device Port* from the side menu and select *Printer*.



Print Output

Ensure the USB port has been configured to the printer before trying to print, see page 218.

- Panel Operation
1. Press the *Utility* key.



2. Press *Hardcopy* from the bottom menu.



3. On the side menu, press *Function* and select *Print*.

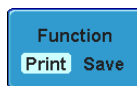

4. Press the *Hardcopy* key to print. The display image is printed out.



Ink Saver

To have a white background on the saved or printed display image, set *Ink Saver* to On.

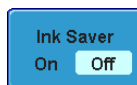

Ink Saver On

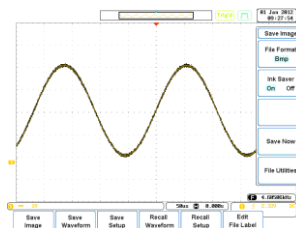

Ink Saver Off

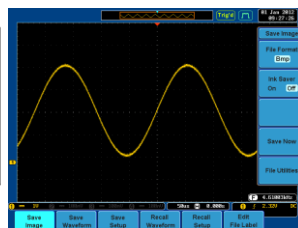

Save - Hardcopy Key

Background When the Hardcopy key is assigned to “Save”, pressing the Hardcopy key can be used to save a screen shot, a waveform, or the current setup, depending on the configuration.

Panel Operation 1. If you wish to save to USB, connect a USB drive to the front or rear panel USB port, otherwise the file will save to internal memory.

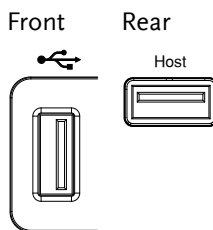

Note

Only one host connection, front or rear, is allowed at a time.

The USB Device port on the rear panel cannot be used concurrently with the USB Host port on the rear panel.

2. Press the *Utility* key.

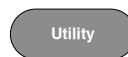

3. Press *Hardcopy* from the bottom menu.



4. On the side menu, press *Function* to select Save.



5. Press *Assign Save To* and select which type of file will be saved when the Hardcopy key is pressed.



File Type: Image, Waveform, Setup, All

6. Press the *Hardcopy* key to save the file*.



A message will appear when the save is successful.

Image saved to USB :/DS0197.BMP.

Image File Format

1. For image files the file format can be selected with the *File Format* key.



Format: BMP, PNG

Ink Saver

2. To have a white background, set *Ink Saver* to On.



Ink Saver On

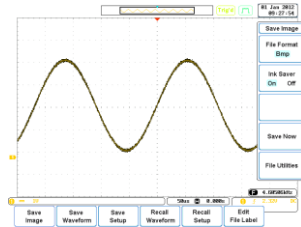

Ink Saver Off

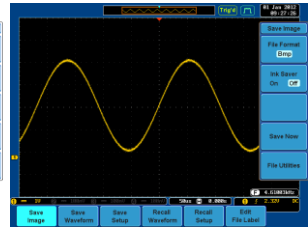

*Each time the Hardcopy key is used to save waveforms or setup files, the files are saved into a new directory each time. The save directory is labeled ALLXXX, where XXX is incremented with each save. This directory is created in either the internal memory or to a USB flash drive.

REMOTE CONTROL

CONFIG





This chapter describes basic configuration for remote control. For a command list, refer to the programming manual downloadable from GWInstek website, www.gwinstek.com

Interface Configuration	223
Configure USB Interface.....	223
Configure RS-232C Interface	224
Configure the Ethernet Interface.....	225
Configure Socket Server.....	228
Configure GPIB	229
USB/RS-232C Functionality Check.....	230
Socket Server Functionality Check	231
GPIB Functionality Check	235
Web Server	238
Web Server Overview.....	238

Interface Configuration

Configure USB Interface

USB Configuration	PC side connector	Type A, host
	GDS-2000A side connector	Type B, device
	Speed	1.1/2.0
	USB Class	CDC (communications device class)

- Panel Operation
1. Press the Utility key. 
 2. Press I/O from the bottom menu. 
 3. Press *USB Device Port* from the side menu and select *Computer*. 
 4. Connect the USB cable to the rear panel device port. 
 5. When the PC asks for the USB driver, select the USB driver included on the accompanying User Manual CD or download the driver from the GW Instek website, www.gwinstek.com, in the GDS-2000A product corner. The driver automatically sets the GDS-2000A as a serial COM port.

Configure RS-232C Interface

RS-232C Configuration	Connector	DB-9, Male
	Baud rate	2400, 4800, 9600, 19200, 38400, 57600, 115200
	Parity	None, Odd, Even
	Data bit	8 (fixed)
	Stop bit	1, 2

Panel Operation 1. Press the *Utility* key.



2. Press *I/O* from the bottom menu.

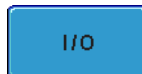

3. Press *RS-232C* from the side menu.



4. Use the side menu to set the *Baud Rate*.



Baud Rate 2400, 4800, 9600, 19200, 38400, 57600, 115200

5. Press *Stop Bit* to toggle the number of stop bits.



Stop Bits 1, 2

6. Press *Parity* to toggle the parity.



Parity Odd, Even, None

7. Press *Save Now* to save the settings.



8. Connect the RS-232C cable to the rear panel port: DB-9 male connector. For a functionality check, see page 230.

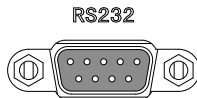

Pin Assignment

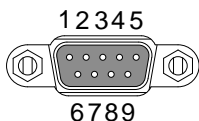

- 2: RxD (Receive data)
- 3: TxD (Transmit data)
- 5: GND
- 4, 6 ~ 9: No connection

PC Connection

Use a Null Modem connection as shown in the diagram below.

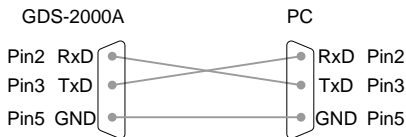

Configure the Ethernet Interface





Ethernet Configuration

MAC Address	Domain Name
Instrument Name	DNS IP Address
User Password	Gateway IP Address
Instrument IP Address	Subnet Mask
	HTTP Port 80 (fixed)



The Ethernet option, DS2-LAN, must first be installed before proceeding. Please see page 30 for further details.

Background The Ethernet interface is used for remote configuration of the oscilloscope over a network using the integrated web server or for remote control using a socket server connection. For details, please see the Web Server Configuration section on page 238 or the Socket Server section on page 228.

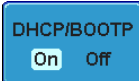
- Panel Operation**
1. Connect the Ethernet cable to the LAN port on the DS2-LAN module. 
 2. Press the *Utility* key. 
 3. Press *I/O* from the bottom menu. 
 4. Press *Ethernet* from the side menu. 
 5. Set *DHCP/BOOTP* to *On* or *Off* from the side menu. 



Note

IP addresses will automatically be assigned with DHCP/BOOTP set to on. For Static IP Addresses, DHCP/BOOTP should be set to off.

MAC Address :	02:51:aa:77:11:16
Instrument Name :	GDS-2074A
User Password :	admin
Instrument IP Address :	172.16.22.149
Domain Name :	
DNS IP Address :	172.16.1.248
Gateway IP Address :	172.16.0.254
Subnet Mask :	255.255.128.0
HTTP Port :	80

ABCDEFGHIJKLMNOPQRSTUVWXYZ abcdefghijklmnopqrstuvwxyz .0123456789-
--

1. Use the variable knob to select a character.
2. Press Select to enter the character.

6. Use the *Up* and *Down* arrows on the side menu to navigate to each Ethernet configuration item.



Items MAC Address, Instrument Name, User Password, Instrument IP Address, Domain Name, DNS IP Address, Gateway IP Address, Subnet Mask

Note: HTTP Port is fixed at 80.

7. Use the *Variable* knob to highlight a character and use the *Select* key to choose a character.

VARIABLE

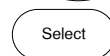
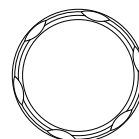

Press *Backspace* to delete a character.



Configure Socket Server

The GDS-2000A supports socket server functionality for direct two-way communication with a client PC or device over LAN. By default, the Sockets Server is off.

Configure Socket Server 1. Configure the IP address for the GDS-2000A. Page 225

2. Press the *Utility* key.



3. Press *I/O* from the bottom menu.



4. Press *Socket Server* from the side menu.



5. Press *Select Port* and choose the port number with the Variable knob.



Range 1024~65535

6. Press *Set Port* to confirm the port number.



7. The Current Port icon will update to the new port number.



8. Press *Server* and turn the socket server On.

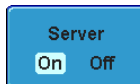

Configure GPIB



Note

To use GPIB, the optional module, DS2-GPIB, must be installed. Please see page 30 for installation details.

Connection

1. Connect a GPIB cable from a PC to the installed GPIB module.

Configure GPIB

2. Press the *Utility* key.



3. Press *I/O* from the bottom menu.



4. Use the Variable knob to set the GPIB Address from the side menu. This option will only be available when the GPIB module is installed.

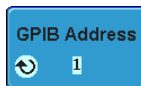

Range 1 ~ 30

- GPIB Constraints
- Maximum 15 devices altogether, 20m cable length, 2m between each device
 - Unique address assigned to each device
 - At least 2/3 of the devices turned On
 - No loop or parallel connection

USB/RS-232C Functionality Check

Terminal Application (USB/RS-232C) Invoke a terminal application such as RealTerm.
 For RS-232C and USB, set the COM port, baud rate, stop bit, data bit, and parity accordingly.

To check the COM port number and associated port settings, see the Device Manager in the PC.
 For WinXP:

Control panel → System → Hardware tab

Example: Configuring RealTerm for RS232C communication.

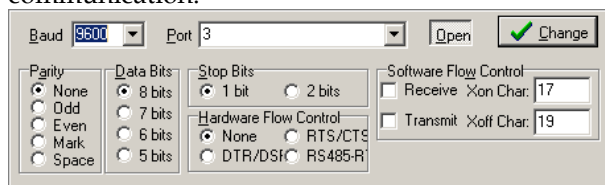

Functionality Check Key in this query command via the terminal application.
 *idn?
 This should return the Manufacturer, Model number, Serial number, and Firmware version in the following format.

GW, GDS-2074A, PXXXXXXX, V1.00



For further details about remote control and remote commands, please see the GDS-2000A programming manual, available on the GW Instek website.

Socket Server Functionality Check

NI Measurement and Automation Explorer To test the socket server functionality, National Instruments Measurement and Automation Explorer can be used. This program is available on the NI website, www.ni.com.

Operation

1. Start the NI Measurement and Automation Explorer (MAX) program. Using Windows, press:



Start>All Programs>National Instruments>Measurement & Automation

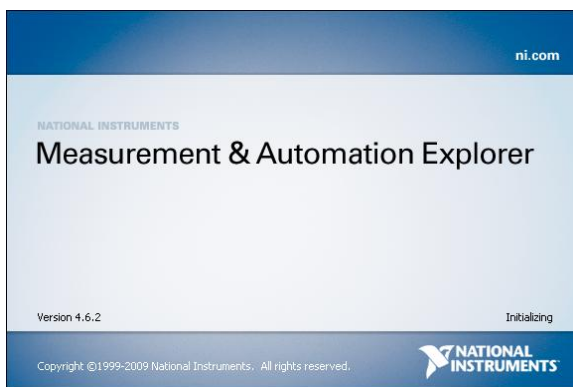

2. From the Configuration panel access;

My System>Devices and Interfaces>Network Devices

3. Press *Add New Network Device>Visa TCP/IP Resource...*

4. Select Auto-detect of LAN Instrument from the popup window. The GDS-2000A should be automatically detected. If the GDS-2000A is not detected, choose the manual option.

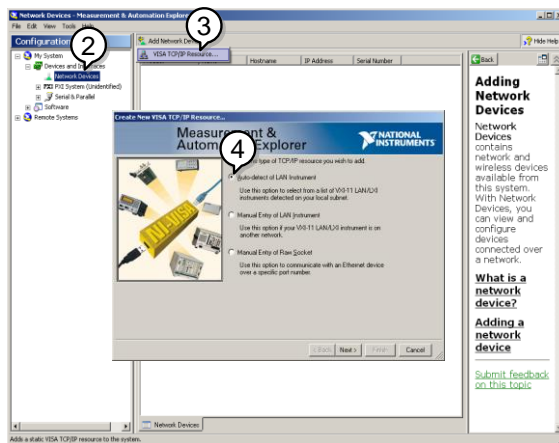

5. Select the IP address that corresponds to the GDS-2000A and click *Next*.

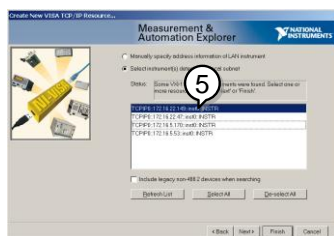

6. The GDS-2000A will now appear under Network Devices in the Configuration Panel.

Functionality Check

7. Click the *Open Visa Test Panel* to send a remote command to the GDS-2000A.

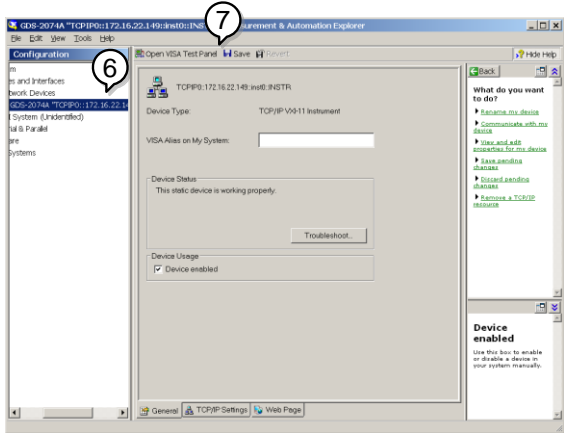

8. Click on the *viWrite* tab. The *IDN? query should already be in the buffer area.
9. Click *Execute* to execute the query.

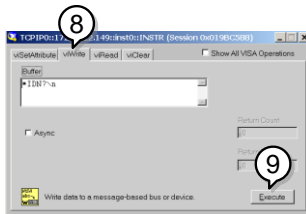

10. Click the *viRead* tab.
11. Click *Execute* to read the return parameter from the *IDN? query.
12. The manufacturer, model number, serial number and firmware version will be displayed in the buffer. For example:
GW, GDS-2074A, P930116, V1.00

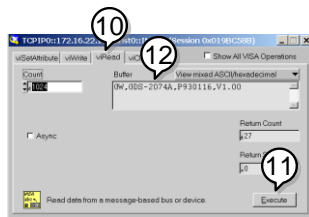

Note

For further details about remote control and remote commands, please see the GDS-2000A programming manual.

GPIB Functionality Check

To check that the GPIB connection is working, National Instruments Measurement & Automation Explorer (MAX) can be used. The following function check is based on version 4.6.2.

For further information about National Instruments, please see the NI website at www.ni.com.

Operation

1. Start the NI Measurement and Automation Explorer (MAX) program. Using Windows, press:



Start>All Programs>National Instruments>Measurement & Automation

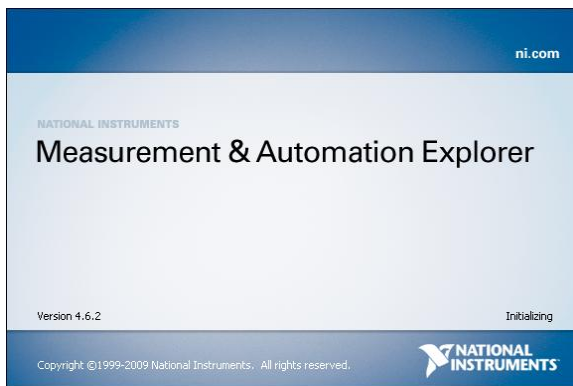

2. From the Configuration panel access;
My System>Devices and Interfaces>GPIB0

3. Press the *Scan for Instruments* button.
4. In the *Connected Instruments* panel the GDS-2000A should be detected as *Instrument 0* with the address the same as that configured on the GDS-2000A.
5. Double click the *Instrument 0* icon.

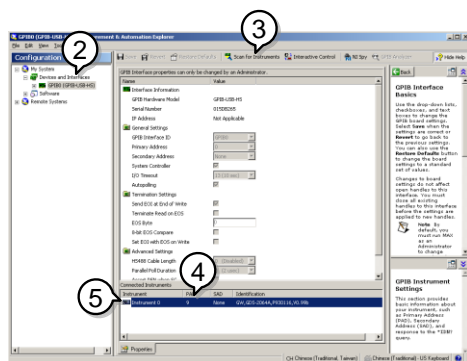

6. Click on *Communicate with Instrument*.
7. In the *NI-488.2 Communicator* window, ensure **IND?* is written in the *Send String:* text box.

Click on the *Query* button to send the **IDN?* query to the instrument.

8. The *String Received* text box will display the query return:

GW, GDS-2XXXX, PXXXXXX, V1.XX
 (manufacturer, model, serial number, version)

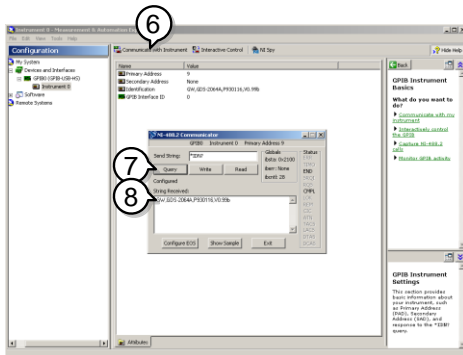

9. The function check is complete.

Web Server

Web Server Overview

Background The GDS-2000A has an inbuilt web server that can be used to:

- view the system information (Welcome Page)
- set/view the network configuration settings (Network Configuration)
- remotely view the current display image on the unit (Get Display Image)

- System Information:**
- Manufacturer
 - Serial Number
 - Firmware version
 - Hostname
 - Domain name
 - IP Address
 - Subset Mask
 - DNS
 - MAC Address
 - DHCP State



[Visit Our Site](#)

[Support](#) | [Contact Us](#)

Welcome Page

Network Configuration

Get Display Image

GDS-2000A Series Web Control Pages

Thanks For Your Using.
Use the left menu to select the features you need.

More How-to
Please refer to user manual.



System Information

Manufacturer:	GW
Serial Number:	P930116
Description:	GW.GDS-2074A
Firmware Version:	V0.96b
Hostname:	G-30116
Domain Name:	
IP Address:	172.16.22.149
Subnet Mask:	255.255.128.0
Gateway:	172.16.0.254
DNS:	172.16.1.248
MAC Address:	02:51:aa:77:11:16
DHCP State:	ON

Copyright 2010 © Good Will Instrument Co., Ltd All Rights Reserved.

- Network Configuration**
- Hostname
 - Domain name
 - IP Address
 - Subnet mask
 - Gateway
 - DNS
 - DHCP State

<p>Welcome Page</p> <p>Network Configuration</p> <p>Get Display Image</p>	<p>Network Configuration</p> <p>Hostname: <input type="text" value="G-30116"/></p> <p>Domain Name: <input type="text"/></p> <p>IP Address: <input type="text" value="172.16.22.149"/></p> <p>Subnet Mask: <input type="text" value="255.255.128.0"/></p> <p>Gateway: <input type="text" value="172.16.0.254"/></p> <p>DNS: <input type="text" value="172.16.1.249"/></p> <p>DHCP State: <input checked="" type="radio"/> ON <input type="radio"/> OFF</p> <p>Password: <input type="password"/></p> <p style="text-align: right;"><input type="button" value="Submit"/></p>
---	---

Get Display Image

- Current display image

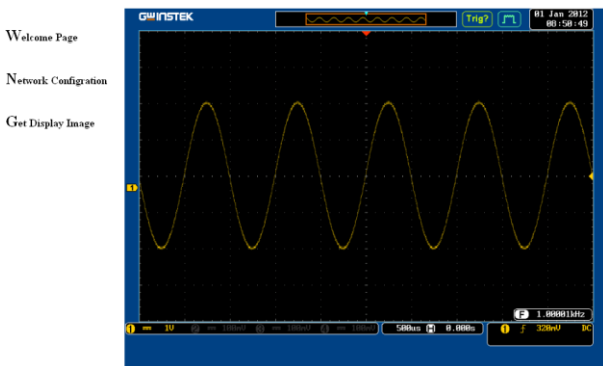

Panel Operation 1. Configure the Ethernet interface. Page 225

2. Enter the IP address of the GDS-2000A unit into the address bar of a web browser.

For example:

http://172.16.20.255

3. The GDS-2000A web browser welcome page appears.

Welcome Page

GDS-3000 Series Web Control Pages

Thanks For Your Using

Use the left menu
to select the features you need.

More How-to
Please refer to user manual.



System Information

Manufacturer:	GW
Serial Number:	P930116
Description:	GW,GDS-3354
Firmware Version:	V1.08
Hostname:	G-30116
Domain Name:	
IP Address:	172.16.20.66
Subnet Mask:	255.255.128.0
Gateway:	172.16.0.254
DNS:	172.16.1.248
MAC Address:	02:50:ad:25:21:21
DHCP State:	ON

Copyright 2010 © Good Will Instrument Co., Ltd All Rights Reserved.

M AINTENANCE

Two types of maintenance operations are available: calibrate vertical accuracy, and compensate the probe. Run these operations when using the GDS-2000A in a new environment.

How to use SPC function	242
Vertical Accuracy Calibration	243
Probe Compensation	244

How to use SPC function

Background Signal Path Compensation (SPC) is used to compensate the internal signal path due to ambient temperature. SPC is able to optimize the accuracy of the oscilloscope with respect to the ambient temperature.

Panel Operation 1. Press the *Utility* key.

A grey, rounded rectangular button with the word "Utility" in black text.

2. Press *System* from the bottom menu.

A blue rectangular button with the word "System" in white text.

3. Press *SPC* from the side menu. A message showing a brief introduction to SPC appears on the screen.

A blue rectangular button with the word "SPC" in white text.

Note

Disconnect all probes and cables from all channels before calibrating.





The DSO needs to be warmed up for at least 30 minutes before using the SPC function.

4. Press *Start* on the side menu to start SPC calibration.

A blue rectangular button with the word "Start" in white text.

5. The SPC Calibration will proceed one channel at a time, from channel 1 to channel 4.

Vertical Accuracy Calibration

- Panel Operation
1. Press the *Utility* key. 
 2. Press *System* from the bottom menu. 
 3. Press *more 1 of 2* from the side menu. 
 4. Press *Self Cal* on the side menu. 
 5. Press *Vertical* on the side menu. 
 6. A message appears to “Now performing vertical calibration...Set CAL to the channel, then press the Vertical key”.
 7. Connect the calibration signal from the rear panel to the Channel 1 input with a BNC cable.

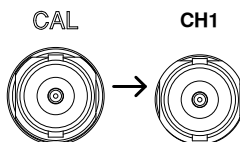

8. Press *Vertical* again after connecting CAL to the channel 1 input. 

The calibration for Channel 1 starts and ends automatically, in less than 5 minutes. A message is displayed when the calibration procedure has ended.

9. Repeat the above step for Channel 2, 3* and 4* when prompted.

*4 channel models only.

10. When the calibration for all channels has completed, the display goes back to the default state.

Probe Compensation

- Panel Operation
1. Connect the probe between the Channel 1 input and the probe compensation output (Demo 3 output, by default set as 2Vp-p, 1kHz square wave) on the front panel. Set the probe attenuation to x10.
 2. Alternatively, the probe compensation signal can be changed. See page 171 for details.

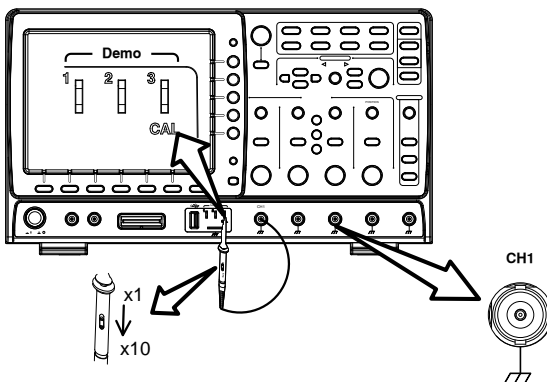

3. Press the *CH1* key to activate CH1.

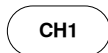

4. Set the *Coupling* to DC from the bottom menu.

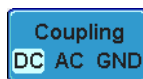

5. Set the Probe attenuation to *Voltage, 10X*.

Page 142

6. Press the *Autoset* key. The compensation signal appears on the display.

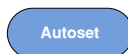

7. Press the *Display* key, then set the display type to *Vector*.

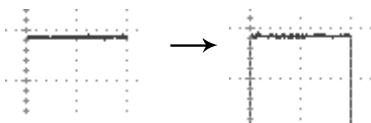
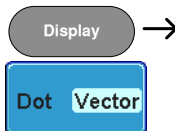

8. Turn the adjustment point on the probe to make the waveform as square as possible.

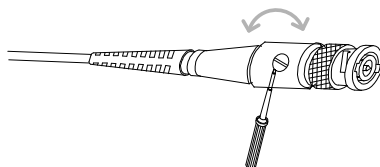
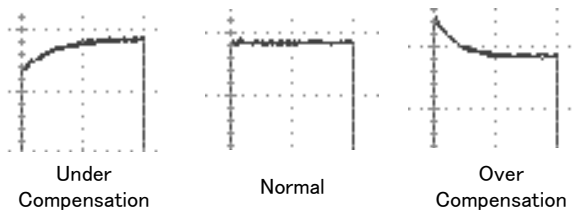

FAQ

- I connected the signal but it does not appear on the display.
- I want to remove the (Measurement result / FFT result / Help contents) from the display.
- The waveform does not update (frozen).
- The probe waveform is distorted.
- Autoset does not catch the signal well.
- I can't save files to the internal memory.
- The display image printout is too dark on the background.
- The date and time settings are not correct.
- The accuracy does not match the specification.

I connected the signal but it does not appear on the display.

Make sure you have activated the channel by pressing the Channel key (the channel key lights up).

I want to remove the (Measurement result / FFT result / Help contents) from the display.

To clear automatic measurement results, press the Measure key, select Remove Measurement and choose Remove All. See page 78.

To clear individual measurements from the screen, press the Measure key, select Display All and choose Off. See page 80.

To clear the FFT result, press the Math key twice. See page 93 for details.

To clear Help result, press the Help key again. See page 63 for

details.

The waveform does not update (frozen).

Press the Run/Stop key to unfreeze the waveform. See page 68 for details.

If this does not help, the trigger mode might be set to Single. Press the Single key to exit Single mode. See page 68 for Single trigger details.

The probe waveform is distorted.

You might need to compensate the probe. For details, see page 244.

Autoset does not catch the signal well.

The Autoset function cannot catch signals under 30mV or 20Hz. Please use the manual operation. See page 66 for Autoset details.

I can't save files to the internal memory.

If a USB stick is inserted into one of the USB slots and you wish to save to the scope internal memory, press the *Utilities* key and set the file path to internal memory.

The display image printout is too dark on the background.

Use the Ink Saver function which reverses the background color. For details, see page 219.

The date and time settings are not correct.

For date and time setting details, please see page 170. If it does not help, the internal battery controlling the clock might be worn out. Contact your dealer or GWInstek.

The accuracy does not match the specification.

Make sure the device is powered On for at least 30 minutes, within +20°C~+30°C. This is necessary to stabilize the unit to match the specification.

For more information, contact your local dealer or GWInstek at www.gwinstek.com / marketing@goodwill.com.tw.

A PPENDIX

GDS-2000A Specifications

The specifications apply when the GDS-2000A is powered on for at least 30 minutes under +20°C~+30°C.

Model-specific

GDS-2072A	Channels	2 + Ext
	Bandwidth	DC ~ 70MHz (-3dB)
GDS-2074A	Channels	4 + Ext
	Bandwidth	DC ~ 70MHz (-3dB)
GDS-2102A	Channels	2 + Ext
	Bandwidth	DC ~ 100MHz (-3dB)
GDS-2104A	Channels	4 + Ext
	Bandwidth	DC ~ 100MHz (-3dB)
GDS-2202A	Channels	2 + Ext
	Bandwidth	DC ~ 200MHz (-3dB)
GDS-2204A	Channels	4 + Ext
	Bandwidth	DC ~ 200MHz (-3dB)
GDS-2302A	Channels	2 + Ext
	Bandwidth	DC ~ 300MHz (-3dB)
GDS-2304A	Channels	4 + Ext
	Bandwidth	DC ~ 300MHz (-3dB)

Common

Vertical	Sensitivity	8 bit
	Resolution	@1MΩ: 1mV*~10V *: When the vertical scale is set to 1mV/div, the bandwidth limit will be set to 20MHz automatically.
	Input Coupling	AC, DC, GND
	Input Impedance	1MΩ// 16pF
	DC Gain Accuracy*	± (5% × Readout + 0.1div + 1mV) when 1mV/div is selected ±(3% × Readout + 0.1div + 1mV) when 2mV/div or greater is selected *: The measurement type is average of ≥ 16 waveforms with the vertical position at zero
	Polarity	Normal & Invert
	Maximum Input Voltage	300Vrms CAT I; 300Vrms CAT II with GTP-150A-2/250A-2/350A-2 10:1 probe
	Offset Position Range	1mV/div ~ 20mV/div : ±0.5V 50mV/div ~ 200mV/div : ±5V 500mV/div ~ 2V/div : ±25V 5V/div ~ 10V/div : ±250V
	Selectable Bandwidth Limit (-3dB)	GDS-207XA: 20MHz BW GDS-210XA: 20MHz BW GDS-220XA: 20MHz, 100MHz BW GDS-230XA: 20MHz, 100MHz, 200MHz BW
	Waveform Signal Process	+ , - , × , ÷ , FFT, FFTrms, d/dt(differentiation), ∫dt(integration), √(square root) FFT:Spectral magnitude. Set FFT Vertical Scale to Linear RMS or dBV RMS, and FFT Window to Rectangular, Hamming, Hanning, or Blackman-Harris.
Trigger	Source	CH1, CH2, CH3*, CH4*, Line, EXT, D0-D15 *four channel models only.
	Trigger Mode	Auto (supports Roll Mode for 100 ms/div and slower), Normal, Single Sequence
	Trigger Type	Edge, Pulse Width (Glitch), Video, Pulse Runt, Rise & Fall (Slope), Timeout, Alternate, Event-Delay(1~65535 events), Time-Delay(Duration, 10nS~10S), Logic*, Bus* *with Logic Analyzer Option

	Holdoff range	10nS to 10S
	Coupling	AC,DC,LF rej. ,Hf rej. ,Noise rej.
	Sensitivity	DC ~ 100MHz Approx. 1div or 1.0mV 100MHz ~ 200MHz Approx. 1.5div or 15mV 200MHz ~ 300MHz Approx. 2div or 20mV
External Trigger	Range	±15V
	Sensitivity	DC ~ 100MHz Approx. 100mV 100MHz ~ 200MHz Approx. 150mV 200MHz ~ 300MHz Approx. 150mV
	Input Impedance	1MΩ// 16pF
Horizontal	Time base	1ns/div ~ 100s/div (1-2-5 increments)
	Range	ROLL: 100ms/div ~ 100s/div
	Pre-trigger	10 div maximum
	Post-trigger	1000 div maximum.
	Timebase	±20 ppm over any ≥ 1 ms time interval
	Accuracy	
	Real Time	1CH: 2GSa/s; 2CH: 1GSa/s
	Sample Rate	
	ET Sample Rate	100GSa/s maximum for all models
	Record Length	1CH: 2Mpts; 2CH: 1Mpts
	Acquisition Mode	Normal, Average, Peak Detect, Single Sequence
	Peak (Glitch) Detection	2nS (typical)
	Average	selectable from 2 to 256
X-Y Mode	X-Axis Input	Channel 1; Channel 3* *four channel models only
	Y-Axis Input	Channel 2; Channel 4* *four channel models only
	Phase Shift	±3° at 100kHz
Cursors and Measurement	Cursors	Amplitude, Time, Gating available
	Automatic Measurement	36 sets: Pk-Pk, Max, Min, Amplitude, High, Low, Mean, Cycle Mean, RMS, Cycle RMS, Area, Cycle Area, ROVShoot, FOVShoot, RPRESshoot, FPRESshoot, Frequency, Period, RiseTime, FallTime, +Width, -Width, Duty Cycle, +Pulses, -Pulses, +Edges, -Edges, FRR, FRF, FFR, FFF, LRR, LRF, LFR, LFF, Phase
	Cursors measurement	Voltage difference between cursors (ΔV) Time difference between cursors (ΔT)
	Auto counter	6 digits, range from 2Hz minimum to the rated bandwidth

Control Panel Function	Autoset	Single-button, automatic setup of all channels for vertical, horizontal and trigger systems, with undo Autoset
	Save Setup	20set
	Save Waveform	24set
Display	TFT LCD Type	8" TFT LCD SVGA color display
	Display Resolution	800 horizontal x 600 vertical pixels (SVGA)
	Interpolation	Sin(x)/x & Equivalent Time Sampling
	Waveform Display	Dots, vectors, variable persistence (16ms~10s), infinite persistence
	Waveform Update Rate	80,000 waveforms per second, maximum
	Display Graticule	8 x 10 divisions
	Display Mode	YT, XY
	Interface	RS232C
USB Port		USB 2.0 host port X2, USB 2.0 device port X1: USB 2.0 full speed (CDC-ACM)
Ethernet Port (LAN)		RJ-45 connector, 10/100Mbps with HP Auto-MDIX, IEEE802.3 (option)
Go-NoGo BNC		5V Max/10mA TTL open collector output
SVGA Video Port		SVGA output (option)
GPIB		GPIB module, IEEE488.2 (option)
Kensington Style Lock		Rear-panel security slot connects to standard Kensington-style lock.
Logic Analyzer (Option)		Sample Rate
	Bandwidth	200MHz
	Record Length	2M max/ch
	Input Channels	16 Digital (D15 - D0) or 8 Digital (D7~D0)
	Trigger type	Edge, Pattern, Pulse Width, Serial bus (I2C, SPI, UART)
	Thresholds	Quad-D0~D3, D4~D7. . . Thresholds
	Threshold selections	TTL, CMOS, ECL, PECL, User Defined
	User-defined Threshold Range	±10V
	Maximum Input Voltage	±40V
	Minimum Voltage Swing	±500mV

	Vertical Resolution	1 bit
Miscellaneous	Multi-language menu	Available
	On-line help	Available
	Time clock	Time and Date ,Provide the Date/Time for saved data
	Dimensions	380mmX220mmX145mm
	Weight	4.2kg
Options	DS2-LAN	Ethernet & SVGA output
	DS2-GPIB	GPIB Interface
	DS2-FGN	DDS Function Generator
	DS2-8LA	8-Channel Logic Analyzer with 8-channel Logic Analyzer Testing Probe
	DS2-16LA	16-Channel Logic Analyzer with 16-channel Logic Analyzer Testing Probe

Probe Specifications

GTP-070A-4

Applicable to: GDS-2072A & GDS-2074A

Position X10	Attenuation Ratio	10:1
	Bandwidth	DC to 70MHz
	Input Resistance	10MΩ when used with oscilloscopes with 1MΩ input.
	Input Capacitance	28pF~32pF
	Compensation Range	25pF~ 45pF
	Max. Input Voltage	≤600Vpk, Derating with frequency
Position X1	Attenuation Ratio	1:1
	Bandwidth	DC to 6MHz
	Input Resistance	1MΩ when used with 1MΩ input
	Input Capacitance	120pF~220pF
	Max. Input Voltage	≤200Vpk, Derating with frequency
Safety	EN61010-031 CAT II	

GTP-150A-2

Applicable to: GDS-2102A & GDS-2104A

Position X10	Attenuation Ratio	10:1
	Bandwidth	DC to 150MHz
	Rise Time	2.3nS
	Input Resistance	10MΩ when used with oscilloscopes with 1MΩ input.
	Input Capacitance	Approximately 17pF
	Compensation Range	10 to 35pF
Max. Input Voltage	500V CAT I, 300Vrms CAT II derating with frequency.	
Position X1	Attenuation Ratio	1:1
	Bandwidth	DC to 6MHz
	Rise Time	58nS
	Input Resistance	1MΩ (Oscilloscope Input)
	Input Capacitance	47pF plus oscilloscope capacitance
	Max. Input Voltage	300V CAT I, 150V CAT II (DC + peak AC) derating with frequency.
Safety	EN61010-031 CAT II	

GTP-250A-2

Applicable to: GDS-2202A & GDS-2204A

Position X10	Attenuation Ratio	10:1
	Bandwidth	DC to 250MHz
	Rise Time	1.4nS
	Input Resistance	10MΩ when used with oscilloscopes with 1MΩ input.
	Input Capacitance	Approximately 17pF
	Compensation Range	10 to 35pF
Position X1	Max. Input Voltage	500V CAT I, 300Vrms CAT II derating with frequency.
	Attenuation Ratio	1:1
	Bandwidth	DC to 6MHz
	Rise Time	58nS
	Input Resistance	1MΩ (Oscilloscope Input)
	Input Capacitance	47pF plus oscilloscope capacitance
Safety	Max. Input Voltage	300V CAT I, 150V CAT II (DC + peak AC) derating with frequency.
		EN61010-031 CAT II

GTP-350A-2

Applicable to: GDS-2302A & GDS-2304A

Position X10	Attenuation Ratio	10:1
	Bandwidth	DC to 350MHz
	Rise Time	1.0nS
	Input Resistance	10MΩ when used with oscilloscopes with 1MΩ input.
	Input Capacitance	Approximately 13pF
	Compensation Range	10 to 25pF
Position X1	Max. Input Voltage	500V CAT I, 300Vrms CAT II derating with frequency.
	Attenuation Ratio	1:1
	Bandwidth	DC to 6MHz
	Rise Time	58nS
	Input Resistance	1MΩ (Oscilloscope Input)
	Input Capacitance	46pF plus oscilloscope capacitance
Safety	Max. Input Voltage	300V CAT I, 150V CAT II (DC + peak AC) derating with frequency.
		EN61010-031 CAT II

GDS-2000A Dimensions

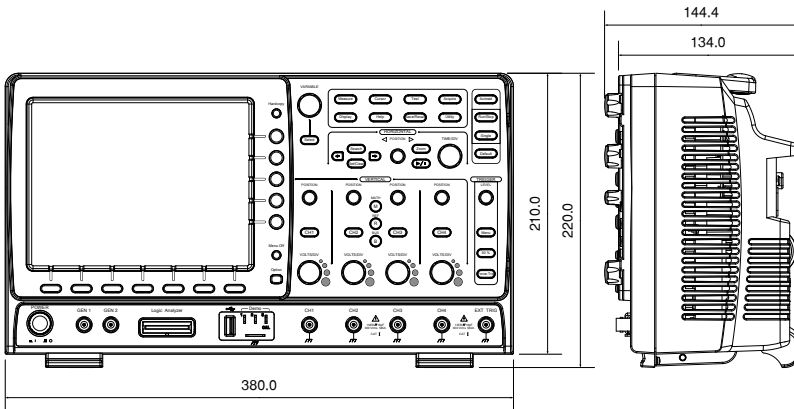
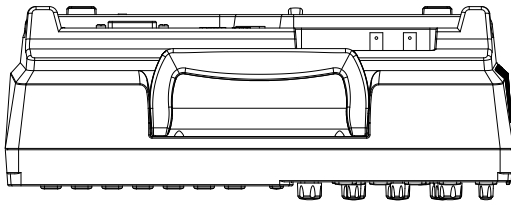

Declaration of Conformity

We

GOOD WILL INSTRUMENT CO., LTD.

No. 7-1, Jhongsing Rd, Tucheng Dist., New Taipei City 236. Taiwan.

GOOD WILL INSTRUMENT (SUZHOU) CO., LTD.

No. 69 Lushan Road, Suzhou New District Jiangu, China.

declare that the below mentioned product

Type of Product: **Digital Storage Oscilloscope**

Model Number: **GDS-2072A, GDS-2074A, GDS-2102A, GDS-2104A,
GDS-2202A, GDS-2204A, GDS-2302A, GDS-2304A**

are herewith confirmed to comply with the requirements set out in the Council Directive on the Approximation of the Law of Member States relating to Electromagnetic Compatibility (2004/108/EEC) and Low Voltage Directive (2006/95/EEC).

For the evaluation regarding the Electromagnetic Compatibility and Low Voltage Directive, the following standards were applied:

© EMC	
EN 61326-1: EN 61326-2-1:	Electrical equipment for measurement, control and laboratory use -- EMC requirements (2013)
Conducted & Radiated Emission EN 55011: 2009+A1: 2010	Electrostatic Discharge EN 61000-4-2: 2009
Current Harmonics EN 61000-3-2: 2006+A1: 2009+A2: 2009	Radiated Immunity EN 61000-4-3: 2006+A1: 2008 +A2: 2010
Voltage Fluctuations EN 61000-3-3: 2008	Electrical Fast Transients IEC 61000-4-4: 2004+A1: 2010
-----	Surge Immunity EN 61000-4-5: 2006
-----	Conducted Susceptibility EN 61000-4-6: 2009
-----	Power Frequency Magnetic Field EN 61000-4-8: 2010
-----	Voltage Dip/ Interruption EN 61000-4-11: 2004

Low Voltage Equipment Directive 2006/95/EEC	
Safety Requirements	EN 61010-1: 2010 (Third Edition) EN 61010-2-030: 2010 (First Edition)

INDEX

- 2-4 channel differences 11
- AC coupling 138
- AC Priority mode 67
- Acquisition 103
 - average 103
 - digital filter 105
 - indicator 27
 - peak detect(glitch) 103
 - record length 109
 - sample 103
 - sampling mode 108
 - XY mode 106
- Advanced math
 - Overview 93
- Amplitude measurements 73
- APP.
 - Go-NoGo 177
 - overview 175
 - run 175, 182
 - uninstall 176
- Area measurements 73
- Auto trigger 147
- Automatic measurement
 - Add measurement 76
 - display all 80
 - gated mode 79
 - High-Low 81
 - overview 72
 - remove measurement 78
 - Statistics 83
- Autoset 66
 - AC Priority mode 67
 - effect on channel 67
 - exception 67
 - Fit Screen mode 67
- Bandwidth filter 140
- Blackman window 94
- Built-in help 63
- Buzzer 170
- Caution symbol 5
- Channel 65
 - status indicator 28
- Cleaning the instrument 7
- Control panel function
 - specification 252
- Convention
 - menu tree 43
- Conventions 35
- Coupling mode 138
- Cursor
 - horizontal 85
 - specification 251
 - vertical 89
- Date setting 170
 - indicator 27
- DC coupling 138
- Declaration of conformity 257
- Default setup 202
 - contents 61, 203
 - effect on channel 66
- Delay measurements 75
- Delay trigger 154
- Demo outputs 171
- Deskew 143
- Dimensions
 - diagram 256
- Display
 - diagram 26
 - search 163
 - segmented memory 113
 - specification 252
- Disposal instructions 8
- Dots 124
- Download information 15
- Edge Trigger 152, 165
- EN61010
 - measurement category 6

pollution degree.....	7	Impedance.....	139
Environment		Initialization.....	33
safety instruction	7	Input frequency indicator	27
Erase memory	170	Intensity.....	125
Ethernet		color	127
interface.....	225	gray	127
Expand by ground/center.....	141	Interface.....	223
External trigger	147	specification.....	252
input terminal	22	Invert waveform	139
specification.....	251	Keys overview	17
FAQ	246	Labels.....	191
FFT	96, 98, 100	Language selection	168
horizontal cursor	87	List of features	12
Overview	93	Logic Analyzer	
vertical cursor	90	specification.....	252
File		Math.....	93
copy	217	basic	94
create folder.....	214	F(x).....	100
delete	216	FFT	96, 98
rename.....	215	Mean measurements.....	73
File navigation.....	212	Memory bar	
File path	213	indicator.....	27
Firmware version.....	169	Menu on/off	129
First time use	33	Miscellaneous	
Fit Screen mode.....	67	specification.....	253
Frequency measurements.....	74	Model difference	11
Front panel diagram.....	16	Module installation.....	30
Glitch trigger	155	Normal trigger.....	147
Go-NoGo.....	177	NTSC.....	149
circuit diagram.....	181	On-screen help	63
timing	181	Optional software	
GPIB		activation	182
function check.....	235	uninstall	183
interface.....	229	Options	
Ground		list.....	253
coupling	138	Overshoot measurements	74
symbol	5	Package contents	15
terminal.....	22	PAL	149
Hamming window	94	PC software download.....	15
Hanning window.....	94	Peak measurements	73
Holdoff.....	151	Peak to peak measurement.....	72
Horizontal		Persistence.....	125
basic operation.....	69	Play waveform	135
position.....	130	Power on/off	
scale	131	safety instruction.....	7
specification.....	251	Printing	
Image file format.....	186		

connection.....	218	configuration.....	114
Hardcopy key.....	219	infomation	123
ink saver	219	list.....	119
Probe		measurement.....	118
attenuation level	142	navigation.....	116
attenuation type.....	142	overview	111
deskew	143	play back.....	117
package list.....	15	run.....	114
Probe compensation.....	244	statistics	119
Program manual download.....	15	Serial number	169
Pulse runt trigger.....	158	Service operation	
Pulse measurements	74	about disassembly.....	6
Pulse width trigger.....	155	contact	248
Rear panel diagram.....	24	Setup	
Recall.....	202	default contents	61
default setup.....	202	file format	189
reference.....	209	Signal path compensation	242
setup	205, 206	Single trigger mode	147
waveform.....	205	Run/Stop	68
Rectangular window.....	94	Slope trigger	160
Reduce menu	38, 39	Socket server	
Remote control.....	222	function check.....	231
interface configuration	223	Socket server	
webserver.....	238	interface.....	228
Rise and fall trigger	160	Software activation.....	182
RMS measurements	73	Software installation.....	31
Roll mode	132	SPC	242
RS-232C		Specifications.....	249
function check	230	Spreadsheet file format	187
interface.....	224	Stop icon	68
Run/Stop.....	68, 129	System information	169
horizontal position	130	Tilt stand	29
Horizontal scale	131	Time setting	170
Save	195	indicator	27
Hardcopy key.....	220	Trigger.....	144
image	196	delay	154
setup	200	edge.....	152, 165
waveform.....	198	glitch width	155
Search		holdoff	151
configuration.....	163	indicator	27
copying search events.....	165	mode.....	152
copying trigger events.....	165	parameters.....	147
navigation.....	165	pulse runt.....	158
save marks	166	pulse width.....	155
set/clear events.....	167	Rise and fall.....	160
SECAM	149	Single	68
Segmented memory		Slope	160

specification.....	250	specification.....	250
status indicator	28	Video trigger.....	157
Timeout	161	Warning symbol.....	5
overview	150	Waveform	
video	157	CSV file contents.....	188
UK power cord.....	9	file contents	187
Uninstall applications	176	how to recall.....	205
Uninstall optional software....	183	how to save.....	198
USB		invert waveform	139
driver download.....	15	play/pause key.....	135
function check.....	230	roll mode.....	132
remote control interface	223	zoom mode.....	133
Vectors.....	124	Waveform color.....	26
Vertical	137	Waveform file format	186
accuracy calibration	243	XY	
basic operation	71	specification.....	251
position.....	137	Zoom waveform.....	133
scale	137		