

# 830

Laser Alignment Tool

## Users Manual

July 2014 (English)

© 2014 Fluke Corporation. All rights reserved. Specifications are subject to change without notice.  
All product names are trademarks of their respective companies.

## LIMITED WARRANTY AND LIMITATION OF LIABILITY

Each Fluke product is warranted to be free from defects in material and workmanship under normal use and service. The warranty period is two years and begins on the date of shipment. Parts, product repairs, and services are warranted for 90 days. This warranty extends only to the original buyer or end-user customer of a Fluke authorized reseller, and does not apply to fuses, disposable batteries, or to any product which, in Fluke's opinion, has been misused, altered, neglected, contaminated, or damaged by accident or abnormal conditions of operation or handling. Fluke warrants that software will operate substantially in accordance with its functional specifications for 90 days and that it has been properly recorded on non-defective media. Fluke does not warrant that software will be error free or operate without interruption.

Fluke authorized resellers shall extend this warranty on new and unused products to end-user customers only but have no authority to extend a greater or different warranty on behalf of Fluke. Warranty support is available only if product is purchased through a Fluke authorized sales outlet or Buyer has paid the applicable international price. Fluke reserves the right to invoice Buyer for importation costs of repair/replacement parts when product purchased in one country is submitted for repair in another country.

Fluke's warranty obligation is limited, at Fluke's option, to refund of the purchase price, free of charge repair, or replacement of a defective product which is returned to a Fluke authorized service center within the warranty period.

To obtain warranty service, contact your nearest Fluke authorized service center to obtain return authorization information, then send the product to that service center, with a description of the difficulty, postage and insurance prepaid (FOB Destination). Fluke assumes no risk for damage in transit. Following warranty repair, the product will be returned to Buyer, transportation prepaid (FOB Destination). If Fluke determines that failure was caused by neglect, misuse, contamination, alteration, accident, or abnormal condition of operation or handling, including overvoltage failures caused by use outside the product's specified rating, or normal wear and tear of mechanical components, Fluke will provide an estimate of repair costs and obtain authorization before commencing the work. Following repair, the product will be returned to the Buyer transportation prepaid and the Buyer will be billed for the repair and return transportation charges (FOB Shipping Point).

THIS WARRANTY IS BUYER'S SOLE AND EXCLUSIVE REMEDY AND IS IN LIEU OF ALL OTHER WARRANTIES, EXPRESS OR IMPLIED, INCLUDING BUT NOT LIMITED TO ANY IMPLIED WARRANTY OF MERCHANTABILITY OR FITNESS FOR A PARTICULAR PURPOSE. FLUKE SHALL NOT BE LIABLE FOR ANY SPECIAL, INDIRECT, INCIDENTAL OR CONSEQUENTIAL DAMAGES OR LOSSES, INCLUDING LOSS OF DATA, ARISING FROM ANY CAUSE OR THEORY.

Since some countries or states do not allow limitation of the term of an implied warranty, or exclusion or limitation of incidental or consequential damages, the limitations and exclusions of this warranty may not apply to every buyer. If any provision of this Warranty is held invalid or unenforceable by a court or other decision-maker of competent jurisdiction, such holding will not affect the validity or enforceability of any other provision.

Fluke Corporation  
P.O. Box 9090  
Everett, WA 98206-9090  
U.S.A.

Fluke Europe B.V.  
P.O. Box 1186  
5602 BD Eindhoven  
The Netherlands

11/99

To register your product online, visit [register.fluke.com](http://register.fluke.com).

# Table of contents

<b>1. Preface</b> .....	<b>.1</b>
Introduction.....	1
How to Contact Fluke .....	1
Safety information.....	2
<b>2. Package</b> .....	<b>.5</b>
<b>3. Safety and operating notes</b> .....	<b>.7</b>
Operating information.....	8
Handling precautions.....	10
<b>4. FLUKE 830 – an overview</b> .....	<b>.13</b>
Description.....	13
Power supply .....	15
Sensor .....	18
Prism .....	20
Mini compact chain-type bracket .....	21
Using the wireless module .....	22
<b>5. Configuration and data management</b> .....	<b>.25</b>
Configuration .....	25
<b>6. Getting started</b> .....	<b>.39</b>
Set up the product.....	39
Enter dimensions.....	39
Wireless measurement.....	41
Diagnose .....	45
<b>7. Horizontal machine alignment</b> .....	<b>.47</b>
Preparing for the alignment procedure .....	47
Check for soft foot .....	48
Mount the brackets.....	48
Mount wireless module, sensor and prism .....	50
Connect the sensor .....	52
Switch Product on and start application .....	53
Enter machine dimensions .....	54
Machine set-up.....	58
Laser beam adjustment.....	60
Take measurements .....	68
Diagnose .....	70
Align machine.....	73
Saving data and printing.....	81
Soft foot .....	91
Main types of soft foot .....	92

Checking and correcting soft foot conditions.....	92
Points to be observed during soft foot measurement.....	96
<b>8. Alignment options</b> .....	<b>101</b>
Measurement modes.....	101
<b>9. Vertical flanged machines</b> .....	<b>107</b>
Typical configuration.....	107
Set-up.....	108
<b>10. Appendix</b> .....	<b>121</b>
Using the sensor cable.....	121
Updating the 830 firmware to a newer version.....	124
Sensor firmware update .....	131
830 Laser Alignment Tool technical data.....	134
Suggested shaft alignment tolerances .....	136
Declaration of conformity.....	137
<b>Index</b> .....	<b>139</b>

## **List of figures**

Figure 2-1. Items included with the Product .....	6
Figure 3-1. Laser safety warning .....	7
Figure 4-1. The Product at a glance .....	13
Figure 4-2. Charging the non-removable rechargeable battery.....	16
Figure 4-3. Dismounting the charger plug .....	17
Figure 4-4. Parts of the sensor .....	19
Figure 4-5. Parts of the prism .....	20
Figure 4-6. Standard and optional brackets .....	21
Figure 4-7. Wireless module ON/OFF switch.....	23
Figure 6-1. Mounting components across the coupling.....	39
Figure 6-2. Laser dot centered on prism dust cap.....	41
Figure 6-3. Centering the reflected laser beam using the thumbwheel and the yellow beam adjustment knob.....	44
Figure 7-1. Mounting the bracket step-by-step.....	49
Figure 7-2. Mounting wireless module and sensor.....	51
Figure 7-3. Mounting and fastening prism.....	51
Figure 7-4. Centering prism knob for maximum adjustment.....	52
Figure 7-5. Inserting sensor cable into the alignment tool.....	53
Figure 7-6. Machine dimensions to be entered .....	55
Figure 7-7. Distance marking on the sensor and prism.....	55
Figure 7-8. Distance marking on the sensor.....	57
Figure 7-9. Horizontal and vertical adjustment of the laser beam .....	65
Figure 7-10. Tolerance bar .....	72
Figure 7-11. Saving measurement report as PDF on a memory stick.....	85
Figure 7-12. Printing measurement report from Product directly to desired printer .....	88
Figure 7-13. Parallel and angular soft foot .....	91
Figure 7-14. Diagnosis of parallel and angular soft foot.....	99
Figure 9-1. Typical vertical machine configuration .....	107
Figure 9-2. Numbering the shaft.....	108
Figure 9-3. Numbering the housing .....	109
Figure 10-1. Replacing the wireless module cable with the sensor cable.....	121
Figure 10-2. Fastening the sensor cable.....	122
Figure 10-3. Memory stick connected to the Product using the 'short' USB cable.....	127



## **List of tables**

Table 1-1. Symbols .....	3
Table 2-1. Package items .....	5
Table 4-1. The Product keyboard and display at a glance.....	14
Table 7-1. Measurement mode and relevant applications .....	68
Table 7-2. FLUKE 830 alignment condition LEDs .....	72





# 1. Preface

## Introduction

The Fluke 830 Laser Alignment Tool (Product) is a laser alignment device used in industrial environments for shaft alignment only. This user-friendly tool, which is used to determine the alignment condition of rotating machinery, features an alphanumeric keyboard with strategically placed navigation keys that handle all data entry functions. The Product possesses a high resolution color backlit TFT screen, file storage capacity of up to 200 measurement files, and an alignment condition LED that gives the instant alignment status of machines. The Product uses rechargeable batteries as well as wireless communication between the Product and its sensor.

## How to Contact Fluke

To contact Fluke, call one of the following telephone numbers:

- USA: 1-800-760-4523
- Canada: 1-800-36-FLUKE (1-800-363-5853)
- Europe: +31 402-675-200
- Japan: +81-3-6714-3114
- Singapore: +65-6799-5566
- Anywhere in the world: +1-425-446-5500

Or, visit Fluke's website at [www.fluke.com](http://www.fluke.com).

To register your Product, visit <http://register.fluke.com>.

To view, print, or download the latest manual supplement, visit <http://us.fluke.com/user/support/manuals>.

## Safety information

A **Warning** identifies conditions and procedures that are dangerous to the user.

A **Caution** identifies conditions and procedures that can cause damage to the Product or the equipment under test.



To prevent eye damage and personal injury:

- Do not look into the laser. Do not point laser directly at persons or animals or indirectly off reflective surfaces.
- Do not look directly into the laser with optical tools (for example, binoculars, telescopes, microscopes). Optical tools can focus the laser and be dangerous to the eye.
- Use the Product only as specified or hazardous laser radiation exposure can occur.
- Do not open the Product. The laser beam is dangerous to eyes. Have the Product repaired only through an approved technical site.



To prevent possible electrical shock, fire, or personal injury:

- Read all safety information before you use the Product.
- Carefully read all instructions.
- Use the Product only as specified, or the protection supplied by the Product can be compromised.
- Make sure machines are locked out, tagged out, and cannot be started accidentally or deliberately during maintenance.
- Do not use the Product around explosive gas or vapour.
- Use only the external mains power supply included with the Product.
- Do not use the Product if it operates incorrectly.
- Use only specified replacement parts.
- Have an approved technician repair the Product.

Table 1-1 is a list of symbols used on the Product and in this manual.

**Table 1-1. Symbols**

<b>Symbol</b>	<b>Description</b>
	Important information. See manual.
	Warning. Laser.
	Conforms to relevant Australian standards.
	Conforms to requirements of European Union and European Free Trade Association.
	Conforms to relevant South Korean EMC standards.
	Conforms to relevant North American Safety Standards.
	This product complies with the WEEE Directive (2002/96/EC) marking requirements. The affixed label indicates that you must not discard this electrical/electronic product in domestic household waste. Product Category: With reference to the equipment types in the WEEE Directive Annex I, this product is classed as category 9 “Monitoring and Control Instrumentation” product. Do not dispose of this product as unsorted municipal waste. Go to Fluke’s website for recycling information.

Page intentionally left blank

## 2. Package

Table 2-1 is a list of all the items included in the purchase of the Product. The items are shown in Figure 2-1.

**Table 2-1. Package items**

<b>Item</b>	<b>Description</b>	<b>Part Number</b>
1	Fluke 830 Laser Alignment Tool	4503893
2	Storage case	4462624
3	Sensor including dust cap and wireless module cable	4503893
4	Prism including dust cap	4476454
5	Chain-type bracket (2 no.) – each comprises two support posts and chain	4503916
6	Wireless module	4476367
7	Sensor cable	4503940
8	Adapter/charger	4503957
9	PC cable	4503925
10	USB cable	4503933
11	USB memory stick	4473175
12	Cleaning cloth	2687537
13	Quick reference guide	4473130
14	Safety sheets	4473148
15	Users manual	N/A



Figure 2-1. Items included with the Product

### 3. Safety and operating notes

The Product is to be used in industrial environments for shaft alignment only. Care must be taken to ensure that the Product is not subjected to mechanical knocks. It must be operated by properly trained personnel only. No liability will be assumed when components or operating procedures as described in this manual are not followed, or altered without permission of the manufacturer.

#### Operating tip

A **Note** denotes general information and tips regarding operation of the Product.

#### IP classification

The Product is dust-tight and protected against water jets (IP65). The sensor and prism comply with code IP67 (dust-tight and protected against immersion).

#### Laser safety

This product uses a Class 2 laser. The laser complies with the requirements of IEC/EN 60825-1 and FDA 21 CFR 1040.10 and 1040.11 with Laser Notice 50. The laser operates at a wavelength of 670 nm with a pulse duration of 128  $\mu$ s, a maximum radiated power of 0.8 mW and a maximum energy of 0.1  $\mu$ J. No maintenance is necessary to keep the product compliant as outlined above.



- Do not stare into beam. Do not point laser directly at persons or animals or indirectly off reflective surfaces.
- Do not look directly into the laser with optical tools (for example, binoculars, telescopes, microscopes). Optical tools can focus the laser and be dangerous to the eye.

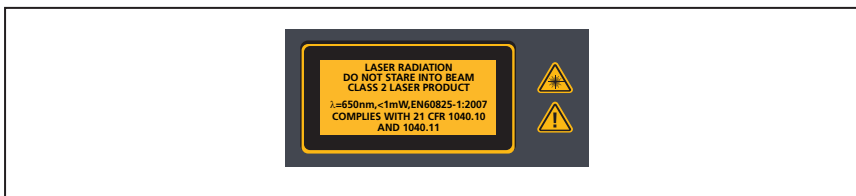

Figure 3-1. Laser safety warning

## Operating information

### Temperature range

The Product and its related system components must be used at temperatures between 0° and 50° C (32° to 122° F). Outside of this range, the specified accuracy may not be maintained.

Store the Product and its related components at temperatures between -20° C and 60° C (-4° F to 140° F).

### Temperature effects and fluctuations

Powerful heat sources or steam located near the laser beam could influence the accuracy of measurements as a result of beam deflection. In practice, however, this effect seldom occurs at distances up to 1 m. If in doubt, the effect can be eliminated by shielding the system from the heat/steam source during measurement and laser beam adjustment.

As with all precision optical measurement devices, sudden fluctuations in temperatures (e.g. resulting from sunlight), could result in erroneous measurements.

#### *Note*

*Allow adequate time for the Product and its related components to reach the ambient temperature.*

### Incident light

Avoid exposing the Product to strong, hot light such as direct sunlight.

### Dust and water seals

The Product is water and contamination resistant to specification IP65; the sensor and prism are resistant to specification IP67. This specification requires that each component be able to withstand a water jet spray from any direction (the components are NOT guaranteed to withstand a full submersion). Note, as with most water-resistant products, the resistance must be periodically checked and re-sealed if necessary. This can be carried out during service and re-calibration of the system which should be carried out every two years.

### Interface connection

The Product is fitted with two interfaces: 1) data exchange with a PC/printer and 2) mains supply for the rechargeable battery, and the sensor.



## Note regarding data storage

### Note

*With any data processing software, data may be lost or altered under certain circumstances. It is strongly recommended that you keep a backup or printed records of all important data.*

*FLUKE assumes no responsibility for data lost or altered as a result of improper use, repairs, defects, battery replacement/failures or any other cause.*

*FLUKE assumes no responsibility, directly or indirectly, for financial losses or claims resulting from the use of this Product and any of its functions, such as loss or alteration of stored data.*

### Note

*Any waste electrical and electronic parts of the Product and its related components, including memory sticks must be disposed off in accordance with the WEEE ( Waste Electrical and Electronic Equipment) Directive. Such parts must be taken to the nearest collection facility.*



## Handling precautions

The Product and its related components are precision instruments and should not be dropped or subjected to physical shock.

### Storage

Use the supplied case to transport the Product and its related components. If the Product is not used for an extended period, remove the related batteries from the components and store the components in a cool, dry and well-ventilated location.



**Observe the storage temperatures and humidity specified in the technical data.**

### Care

All optical surfaces (prism, sensor lens) must be kept clean. Use only the supplied lens cleaning cloth. Avoid vigorous polishing to preserve the anti-reflective coatings of the glass elements. The housings of the Product, sensor, and prism may be wiped clean using a soft cloth dampened with a mild, non-abrasive detergent (use soapy water with only 1% mild soap in water). The display should be cleaned using a soft dry cloth.

### Maintenance

Although the Product and its related components are essentially maintenance-free, the following points should be observed:

- The calibration accuracy of the sensor should be checked every two years.
- Please return the system components to your authorized service center for calibration checking.



- **Do not open the Product. The laser beam is dangerous to eyes. Have the Product repaired only through an approved technical site.**
- **Use only specified replacement parts.**
- **Have an approved technician repair the Product**



**When returning the Product and its battery operated components for calibration, service or repair, ensure that the batteries are not defective. If you suspect a defect in the battery, DO NOT ship the unit with the defective battery. You may contact your local representative for further information.**

*Note*

*Refer to the relevant safety data sheets for the batteries used. The packaging and dispatch regulations for any given battery are described under paragraph 14 in the safety data sheets.*

**Disposal**

Any waste electrical and electronics parts of the Product and its related components including memory sticks must be disposed of according to applicable safety and environmental regulations.

Customers in member states of the European Union must adhere to the EU directive 2002/96/EC on waste electrical and electronic equipment (WEEE). Items that fall under this directive are marked with the shown crossed-out wheeled bin symbol and must be disposed of according to this directive.

- The marked components must be disposed of with FLUKE or their authorized disposal partners.
- Such parts must be taken to the nearest collection facility.
- If you have any questions regarding the WEEE Directive, please contact your local sales representative.



Page intentionally left blank

## 4. FLUKE 830 – an overview











### Description



Figure 4-1. The Product at a glance

## The Product at a glance

Table 4-1. The Product keyboard and display at a glance

Item	Element	Function
1		The 'Setup' key opens the machine dimensions screen.
2		The 'Measure' key is used to start the measure process.
3		The 'Diagnose' key is used to display measured and corrective alignment results.
4	LED (battery status/ wireless communication indicator)	Shows the battery and wireless communication statuses.
5	USB PC/printer port (grey)	The port is used to charge the Product, print and save measurement files, carry out firmware updates as well as display screen on a PC.
6	Ambient light sensor	Use to regulate the Product's display brightness.
7	Sensor port (blue)	The port is used to connect to Product when the wireless module is not available.
8	LED (alignment condition and laser beam adjustment)	Used for laser beam adjustment and as a tolerance check for measured alignment condition.
9		The 'Menu' key is used to access the main menu which possesses the Product's useful functions.
10		The 'On' key is used to switch the Product on. The Product is switched off via the main menu item 'Turn off'.
11		The navigation keys are used to navigate through the program steps.
12		The 'Enter' key is used to confirm entered values and access any selected item.
13		The 'Back' key is used to return to previously selected screen.
14		The 'Clear' key is used to delete information entered inadvertently.
15		The data entry keys are used to enter machine dimensions and file name.

## Power supply

The Product is powered using a non-removable 7.4 V 2.6 Ah Lithium-ion polymer rechargeable battery, which is to be charged via the USB port only using the universal adapter/charger. The rechargeable battery allows operation of up to 17 hours (33% active measurement, 33% computation, 33% 'sleep' mode).

The rechargeable battery may also be used to power the sensor when measurement is carried using the sensor cable and not the wireless module.



**The rechargeable battery is housed in a compartment that is held closed using a special screw and must never be tampered with. When the battery can no longer hold charge, the Product must be sent back for service.**

## Charging the battery

### *Note*

*Charging the non-removable rechargeable battery is possible only via the Product.*

To charge the rechargeable battery, connect the adapter/charger to the Product USB port (grey) and to the mains supply (see Figure 4-2).

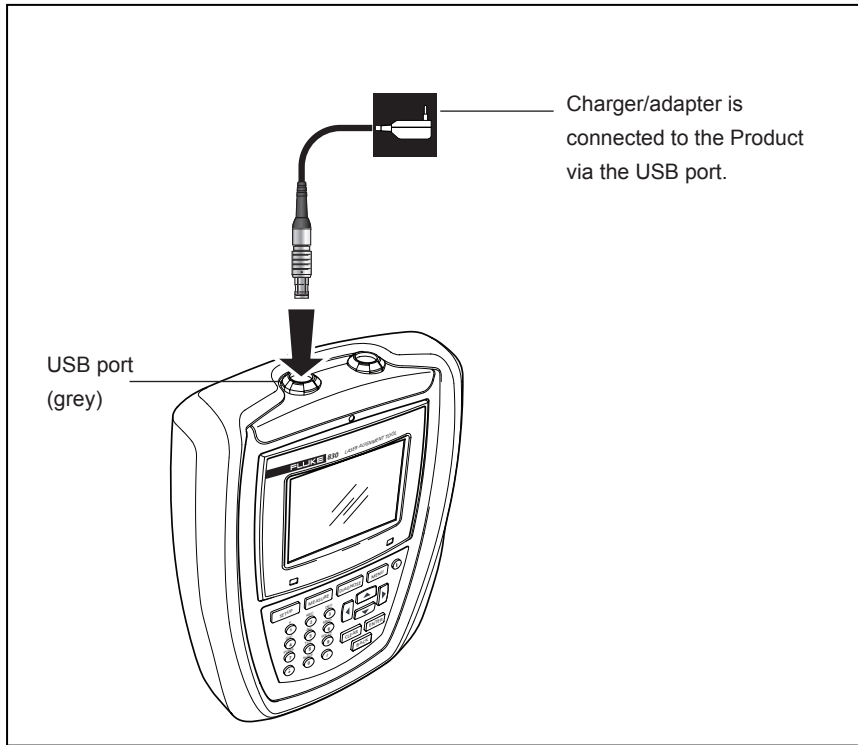

**Figure 4-2. Charging the non-removable rechargeable battery**

*Note*

*Before charging, the rechargeable battery should be discharged as much as possible. To charge the battery from 0% to 100% capacity takes approximately 4 hours.*

The battery LED indicates the charging status of the battery. The LED flashes green at initialization and during the charging process. A constantly lit green LED denotes that the battery is fully charged.

The charge level of the battery is displayed under the menu item 'Device settings'. With system switched on, pressing **MENU**, then using the navigation keys to highlight 'Config'. Confirm selection by pressing **ENTER** and from the configuration menu use the navigation keys to highlight 'Device setting'. Confirm selection by pressing **ENTER**. The device settings are displayed.





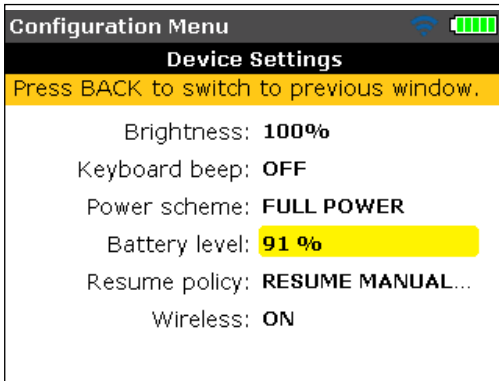

### Mounting and dismounting the universal adapter/charger plug

The universal adapter/charger comes with three different regional plugs. The available plugs are for the Euro zone, the US, and the UK. When mounting or dismounting a plug, pay attention to the direction of the arrow on the plug just above the pins, and the arrow on the latching nipple on the charger housing. To dismount a plug, push the latching nipple in the forward direction [1] as indicated by the arrow on it and hold, then push the plug to the right [2] as on the arrow on the plug.

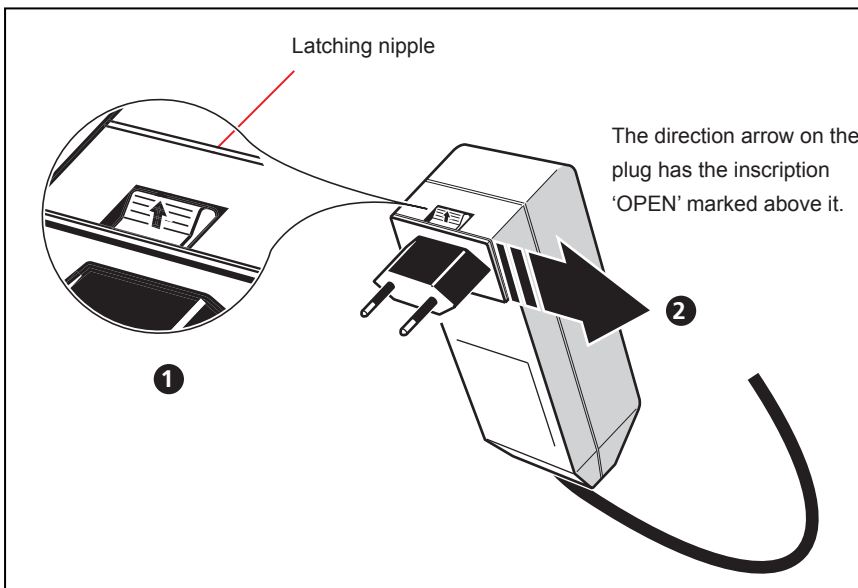

Figure 4-3. Dismounting the charger plug

To mount a plug, push the latching nipple in the forward direction [1] as indicated by the arrow on it then slip the plug into the protruding prongs and slide it to the left until it latches.

## Sensor

The sensor is mounted using the chain type bracket on the shaft or solid coupling of the stationary machine.

The sensor contains a laser diode which emits a beam of red light (wavelength 670 nm). The beam is visible at the point it strikes a surface. It is emitted with a diameter of approx 5 mm (3/16"). Also located in the same housing is a beam detector which measures the exact position of the laser beam as the shafts are rotated. This component is a biaxial, analog, photoelectric semiconductor position detector with a resolution of 1  $\mu$ m. The sensor also contains an electronic inclinometer with resolution better than 1° for measurement of the shaft rotation angle.

The sensor has two indicator LEDs on its front side, one green for indicating beam adjustment, and the other red when the laser is on. The sensor is powered by using the wireless module which also transfers measurement data from the sensor to the Product. The sensor may also be powered by the Product via a cable through which measurement data also passes.

The sensor is IP67 protected to resist water spray and dust. The internal optics and electronics are sealed to prevent any possible contamination. The sensor lens, however, must be kept clean. Use the lens cleaning cloth or a fine dusting brush such as that normally used to clean other optical devices. Keep the dust cap on when not in use.

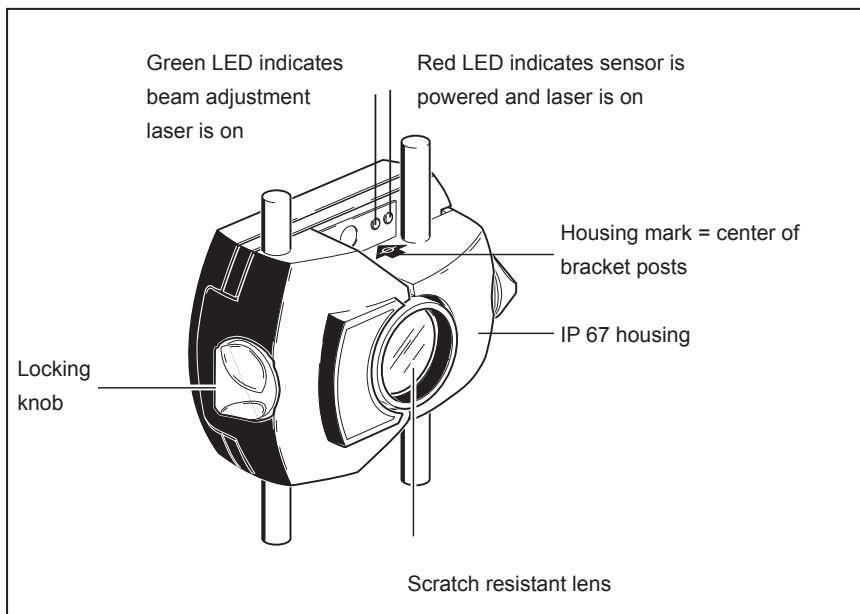

Figure 4-4. Parts of the sensor

 **Caution**

Avoid polishing the lens too vigorously to prevent irreparable damage to its anti-reflective coating.

 **Caution**

Under no circumstances may the six smaller housing screws be removed, as that would result in loss of calibration and would void all warranty coverage.

*Note*

*The calibration accuracy of the sensor should be checked every two years as indicated by the colored label located on the back of the sensor housing. Please return the sensor to your authorized service center for calibration checking.*

  **Warning**

Do not stare into the beam.

## Prism

The prism is mounted on the shaft or solid coupling of the machine to be moved. It reflects the laser beam back into the position detector as the shafts are rotated. The locking lever flips into the horizontal position, facing forward, to hold the prism in place on the bracket posts. The prism is adjusted by changing its vertical position and its horizontal angle (using the thumbscrews) so that the beam is reflected directly back into the sensor.

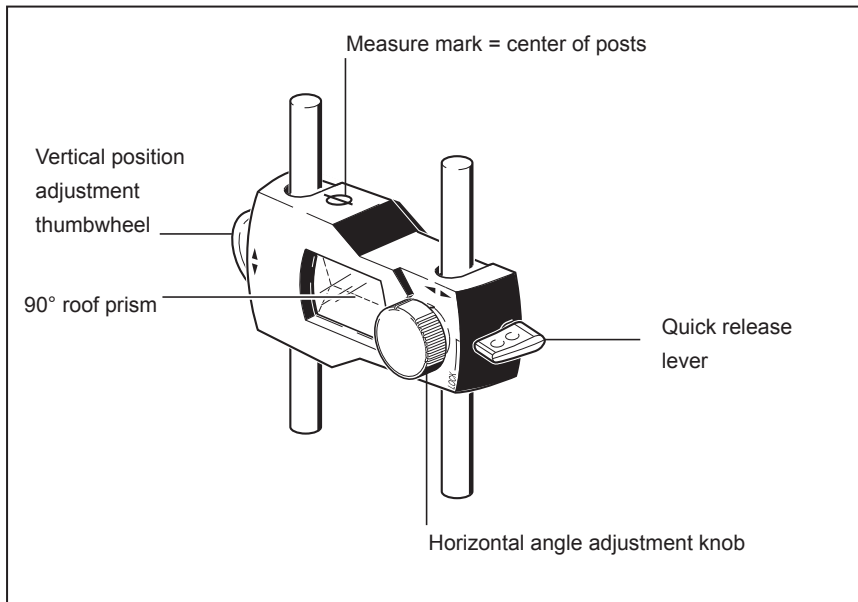

**Figure 4-5. Parts of the prism**

The prism must be kept clean. Use the lens cleaning cloth or a fine dusting brush such as that normally used to clean other optical devices.



**Avoid vigorous polishing to preserve the anti-reflective coating. Keep the dust cap on the prism when it is not in use.**

## Mini compact chain-type bracket

Compact and lightweight, this bracket is designed to provide extremely rigid support for the measurement components with a minimum of mounting time and effort. The chain-type bracket fits onto shafts and couplings ranging from 15 to 200 mm (1/2" to 8") in diameter. [Note that the brackets themselves cover the full range of diameters; it is only the chain lengths that limit.] Chains of varying lengths are also available. Mounting instructions are given in the section 'Mount the brackets' on page 48.

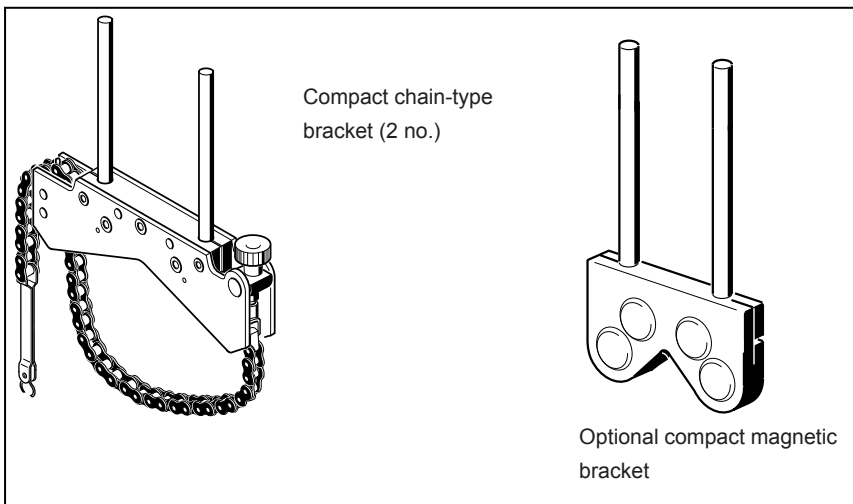

**Figure 4-6. Standard and optional brackets**

*Note*

*Package contents are shown in the "Package" section starting on page 5.*

## Using the wireless module

The wireless module powers the sensor laser and passes alignment readings from the sensor to the Product. The module covers direct line of sight distances of up to 10 m / 33' depending on the prevailing environmental conditions. Its electronic compartment complies with code IP65 (dust tight and protected against water jets). The module is powered by two 'AA' size batteries. The operating time for the alkaline batteries is 14 hours – based on an operating cycle of 50% measurement, 50% standby. Lithium-ion AA batteries (such as for cameras) may also be used, in place of alkaline batteries. For lithium-ion batteries, the operating time is significantly longer; however, the drop-off rate when they become depleted is much faster than with alkaline batteries, providing less advance warning.

### Mounting the wireless module

Mount the wireless module on the support posts of the bracket fixed on the shaft of the left machine (usually stationary machine) as shown in Figure 7-2. The module slides onto the support posts and is held in place by friction fit. It is recommended to mount the wireless module on to the bracket frame. Mount the sensor on the support posts, and then connect its cable to the wireless module by inserting the longer 90-degree connector of the cable into the four-pin socket on the side of the module with a groove (see Figure 7-2).

#### *Note*

*Match the red dot on the plug to the groove on the socket to ensure proper plug orientation.*

## Switch the wireless module on

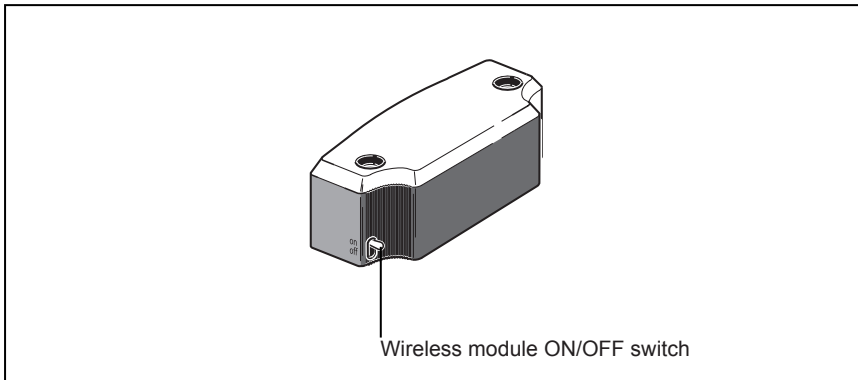

**Figure 4-7. Wireless module ON/OFF switch**

After connecting the sensor to the wireless module, switch the wireless module on (see Figure 4-7).

The battery status LEDs blink for 3 seconds. The module is now ready for operation. When the module is switched on, it supplies power to the sensor. If no measurement action is activated in the Product, the power supply to the sensor stops.

## Operating time of battery status LED indicators

State of LEDs	Indicates
3 LEDs lit continuously	Operating time is between 75%–100%
2 LEDs lit continuously	Operating time is between 50%–75%
1 LED lit continuously	Operating time is between 25%–50%
Only 1 LED blinking (slowly)	Operating time is under 25%
Only 1 LED blinking (very fast)	Operating time in critical phase. Measurement should not be taken

### Note

*The operating time may vary significantly depending on the type of batteries used.*

Page intentionally left blank



## 5. Configuration and data management

### Configuration

The configuration menu is used to configure the Product's settings, the regional settings, default settings, printer, licence available applications, and display specific system details.

The configuration menu may be accessed at any time and from any screen. With the Product switched on, access "Configuration menu" screen by pressing **MENU**. The "Main menu" screen appears. Use the navigation keys and highlight the 'Config' icon.

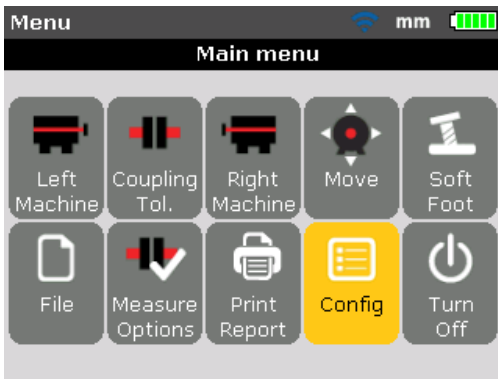

With 'Config' highlighted, press **ENTER** to open the "Configuration menu" screen. Any of the configuration menu items may be highlighted using the navigation keys

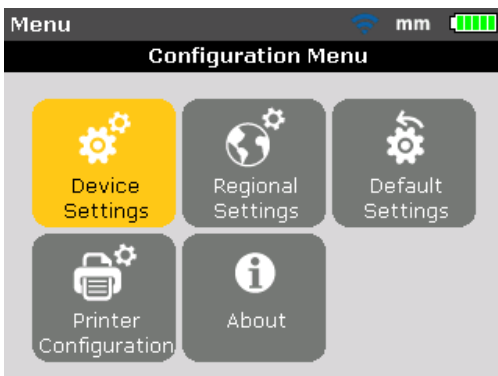

## Device settings

To open the “Device settings” screen, use the navigation keys to highlight the ‘Device settings’ icon then confirm selection by pressing **ENTER**. The available settings are displayed. These include brightness, keyboard beep, power scheme, battery level, resume policy and Wireless. Use **▲**/**▼** to select item to be set.

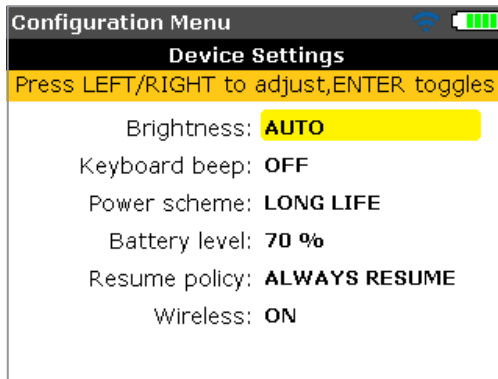

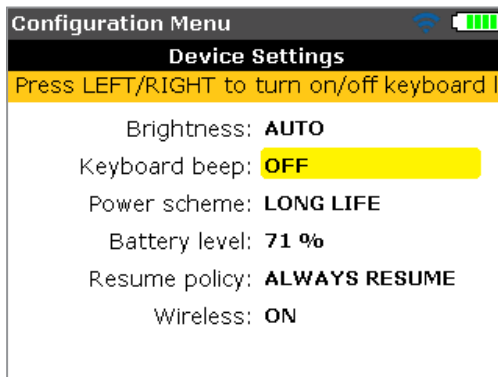

The Product possesses two modes to regulate display brightness – the auto mode and the manual mode. Auto mode enables adaptive brightness, and uses a light sensor to automatically adjust the display brightness to match the ambient lighting conditions. Use **ENTER** / **◀** / **▶** to revert to the manual mode where display brightness is manually controlled. Pressing **▶** increases the brightness and **◀** decreases display brightness.

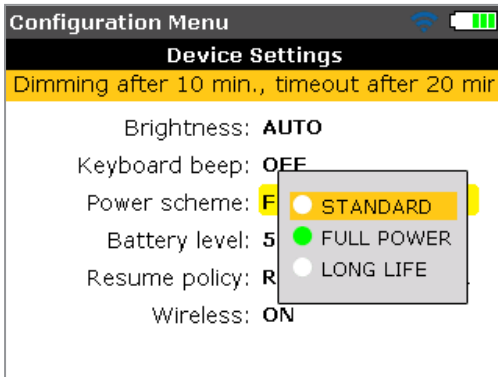

Press **ENTER** to toggle between keyboard beep on/off. When the keyboard beep is enabled (on), a beeping sound accompanies the pressing of any key.



The power scheme option is used to select setting that manages the power usage within the Product. The three available options are: 'Standard' (the display dims after 10 minutes and shuts down after 1 hour), 'Full power' (no dimming and no shutdown), and 'Long life' (the display dims after 3 minutes and shutdown takes place after 8 minutes). The required setting is selected using   and confirmed by pressing .

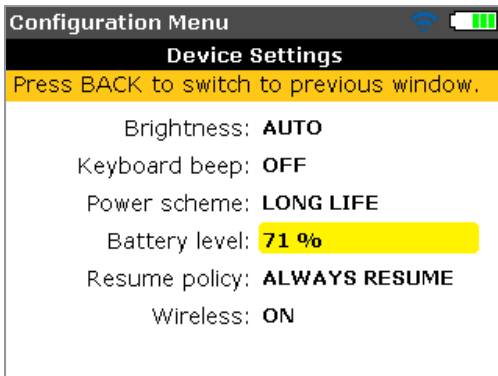

The capacity of the battery appears next to the battery level bar. This value corresponds to the charge level indicated on the battery icon that appears on the right top corner of the display, and appears in every screen.

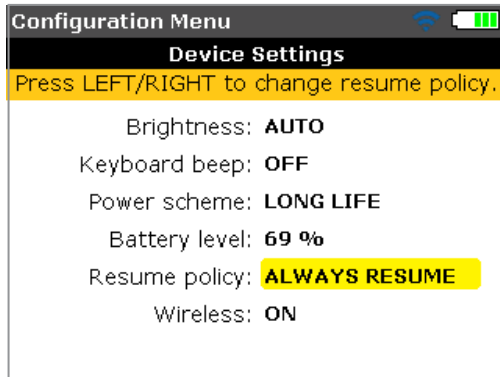

“Resume policy” allows the user to specify the measurement file that opens when the Product is turned on. The system may be set to open the last used measurement file (‘Always resume’) or open a new measurement file (‘Resume manually’). Press **ENTER** to toggle between the two resume options. As an alternative, use can be made of **▶**/**◀** to toggle between the two resume policies.

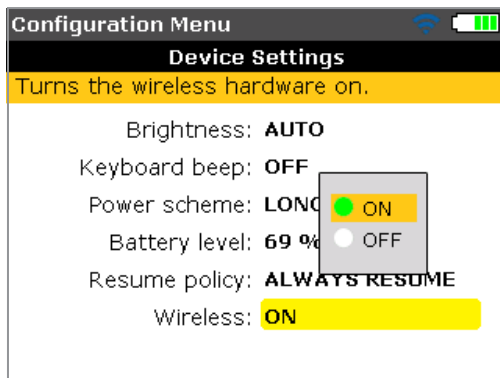

The item ‘Wireless’ is used to enable or disable the ‘wireless’ capability of the Product. To turn the ‘wireless’ capability on/off, press **ENTER** with the item highlighted. The on/off box appears. Use **▶**/**◀** to select either ‘on’ (to enable ‘wireless’ capability) or ‘off’ (to disable ‘wireless’ capability), then press **ENTER** to confirm selection.

## Regional settings

This option is used to set the units of measurement, the preferred country language, current date and time.

### Note

*The country language determines the format in which the date can be displayed.*

The screen is opened from the configuration menu. Use the navigation keys to highlight the “Regional settings” icon then confirm selection by pressing **ENTER**.

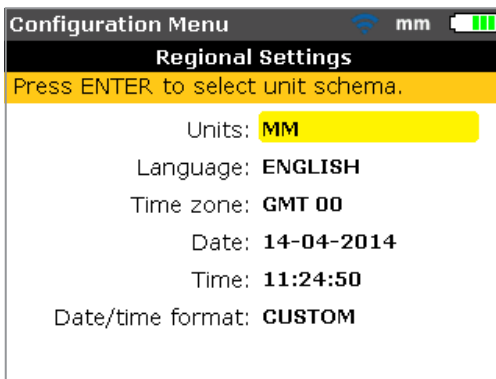







Highlighting ‘Units’ using **▲**/**▼** and confirming selection by pressing **ENTER** reveals the available units of measurement. These are US imperial customary units (inch/mils), imperial units (inch/thou) and the SI units (mm). Select the required system of units using **▲**/**▼**. Press **ENTER** to confirm selection.

Highlighting ‘Language’ using **▲**/**▼** and confirming selection by pressing **ENTER** displays a list of the available country languages. Select the preferred country language using **▲**/**▼**. Press **ENTER** to confirm selection.



### Note

*Before the country language is set, a hint appears requesting whether the units, date and time format should also be changed to match the default language values. Use **▲**/**▼** to select action required and confirm by pressing **ENTER**.*

Highlighting 'Time zone' using / and confirming selection by pressing  displays the different time zones. The required zone is selected using / and confirmed by pressing .

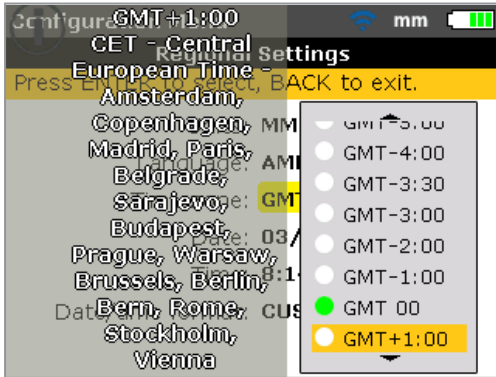
When a time zone is initially highlighted, a hint appears displaying major world cities within the selected time zone. Note that changing the time zone automatically alters the time set.





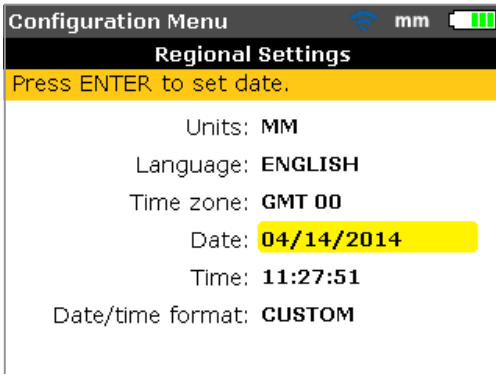



Current date and time are set by highlighting the respective option using / and confirming selection by pressing .



#### Note

*The date format displayed here is set via the option 'Date/Time format'.*

Use / to navigate through the date (day, month or year – dependent on format). Use / to set the highlighted date component. Use  to advance date and  to reverse date.

Alternatively, use the data entry keys to set the date. With the required date component highlighted, enter the new date component using the data entry keys. On pressing the first key, the editing box appears.

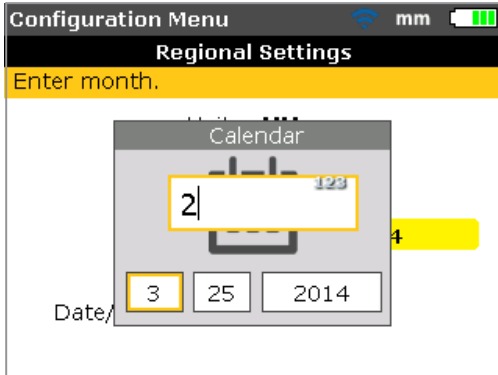

Enter value then confirm entry using either **BACK** or **ENTER**.

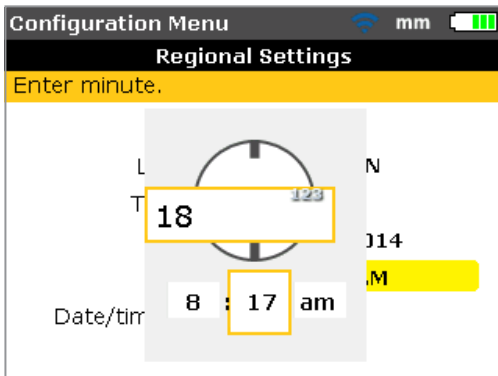

*Note*

*The time format displayed here is set via the option 'Date/Time format'.*

Use **←**/**→** to toggle between hours and minutes. Use **▲**/**▼** to set the highlighted time component. Use **▶** to advance time and **◀** to reverse time.

Alternatively, use the data entry keys to set the time. With the required time component highlighted, enter the new time component using the data entry keys. On pressing the first key, the editing box appears. Enter value then confirm entry using either **BACK** or **ENTER**.

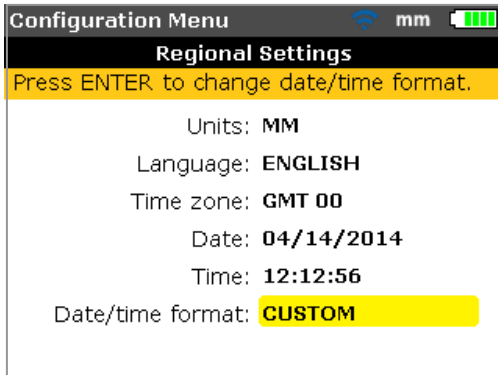

Pressing **ENTER** with 'Date/time format' highlighted reveals a menu box with the items 'Date format' and 'Time format'. Use **▲**/**▼** to select either item, confirming selection by pressing **ENTER**.

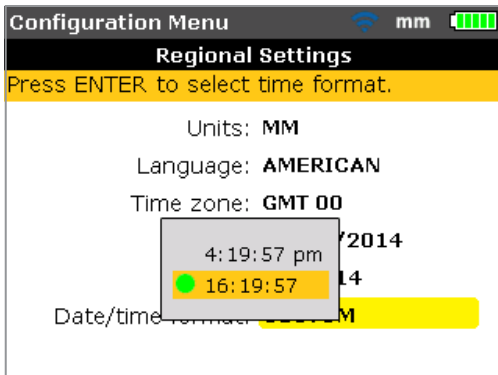

The time format is used to set either the 12h or 24h notation. The selected notation is confirmed by pressing **ENTER**.  
The date format is used to set dd-mm-yyyy or mm/dd/yyyy format.



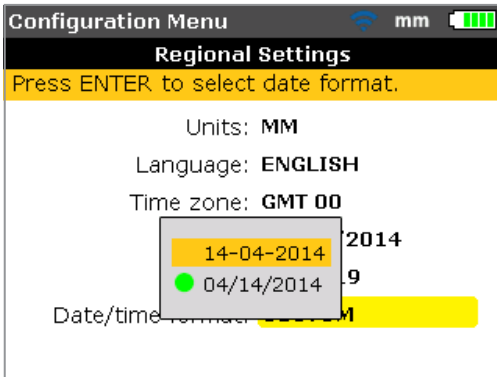

## Default settings

To open the “Default settings” screen, use the navigation keys and highlight the ‘Default settings’ icon while in the configuration menu, then confirm selection by pressing **ENTER**. The screen is used to set specific default parameters. Use **UP** / **DOWN** to cycle through the parameters. The default changes are effective upon restart or if a new file is created.

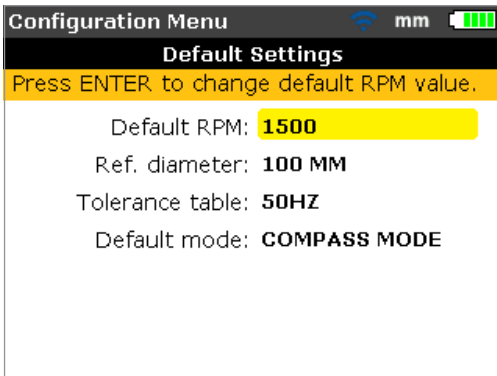

- Default RPM – used to set the required default rpm. Highlight ‘Default RPM’ then use the data entry keys to enter the required default rpm. Confirm entry by pressing **ENTER** / **BACK**.
- Reference diameter – used to set the required reference diameter. Highlight ‘Ref. diameter’ then use the data entry keys to enter the required reference diameter. Confirm entry by pressing **ENTER** / **BACK**. Every new alignment file started will then automatically be preconfigured with this RPM value already entered. Every new alignment file started will then automatically be configured with this coupling diameter value already entered.

- Tolerance table – the available options are 50 Hz and 60 Hz. The mains supply frequency determines the standard RPM values that appear in the tolerance table. Tolerance values based on these frequencies may be read off the suggested tolerance table.
- Default mode – used to set the default measurement mode. Two measurement modes are available, 'Compass' mode (for horizontal machines) and 'Clock' mode (for vertical machines). In 'Compass' mode, measurement points are taken at any three of the eight measurement sectors available. In the 'Clock' mode measurements are taken at any three of the eight clock positions ( 12:00, 1:30, 3:00, 4:30 6:00, 7:30, 9:00 and 10:30).

### Printer configuration

This option is used to set up printers and the printing configuration within the Product.

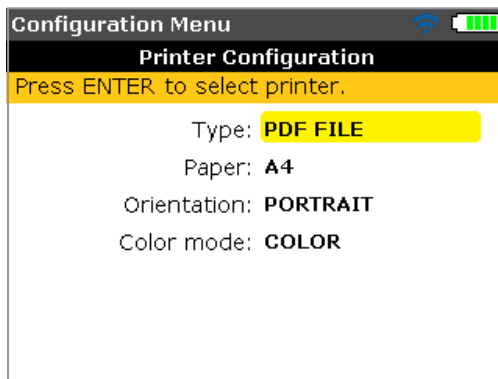

Four printing options can be set using "Printer configuration".

"Type" – Selecting "Type" and then pressing **ENTER** displays a list with all supported printers.

"Paper" – Used to select the required paper size

"Orientation" – Used to set the paper orientation. Select "Portrait" for a vertical layout and "Landscape" for a horizontal layout.

"Color mode" – Used to set the color mode in which the measurement report is to be printed. This can either be in full color or in grayscale.

### About application

The information contained under this section is accessed by highlighting the 'About' icon while in the configuration menu screen. Confirm selection by pressing **ENTER**. The displayed information depicts the current status of the device and application.

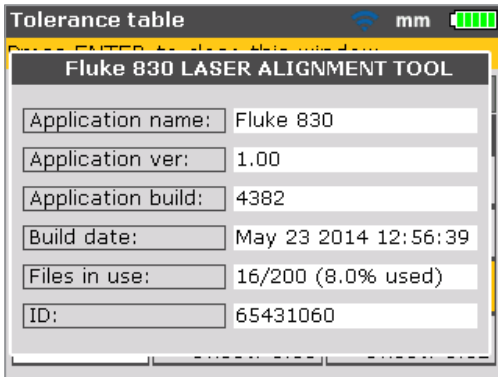

### Data management

The Product possesses an effective file and data management facility. To access the file and data management options, press **MENU** then use the navigation keys to highlight the 'File' icon.

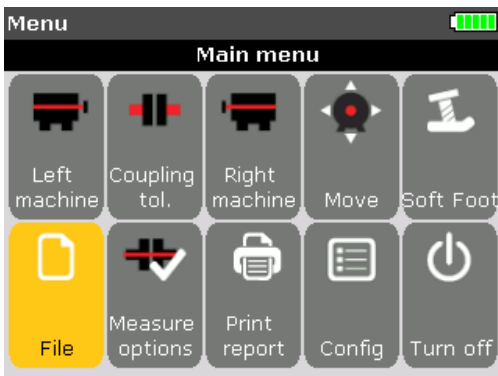

Press **ENTER** to confirm selection. The "File menu" screen appears.

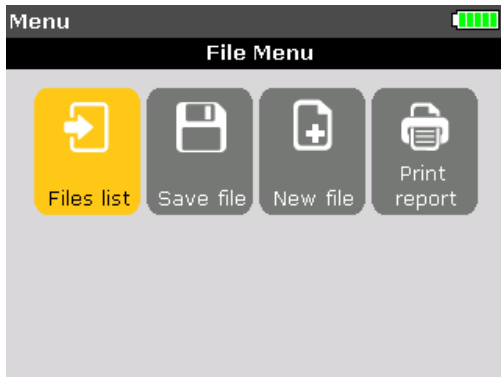

Use **▶**/**◀** to highlight any one of the four file and data management options. These are 'Files list', 'Save file', 'Resume' (or 'New file') and 'Print report'.

#### Note

*Note that the file menu items 'Resume' and 'New file' appear depending on the selected file resume policy which is set under the configuration item 'Device settings'. If 'Resume manually' is the set policy, then 'Resume' appears only when a file is opened and has not been saved. If 'Always resume' is the set policy, 'Resume' appears when a file has been saved.*



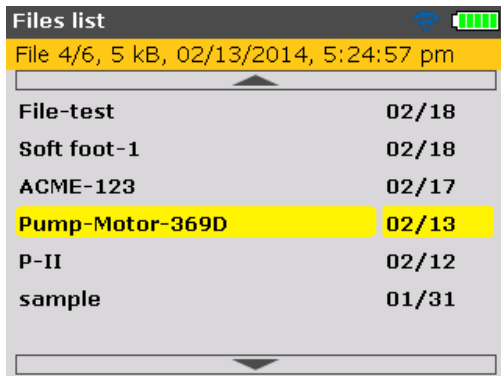



'Files list' – This option is used to load any stored file. Highlight 'Files list' using **▶**/**◀** then press **ENTER** to confirm selection. The Open file screen appears displaying all the files saved.



By default, the files are listed in order of date and time of creation. This listing order is not user-editable.

Use **▲**/**▼** to highlight file to be opened then press **ENTER** to open the file.



Note

An existing file may be deleted by highlighting it using   then pressing . When a hint screen appears, use   to highlight 'Yes'. The file is deleted by pressing  to confirm deletion.

To rename an existing file, use   to highlight the file, then use the data entry keys to edit file name and confirm changes by pressing .

'Save file' – This option is used to save the current file. If the file is new and does not yet have a name, use the data entry keys to enter the new file name in the editing box that appears.

Note

When entering names that contain both upper and lower case characters as well as numerals, use  to cycle through the three options. Press and hold down  while observing the status indicator at the top right corner of the editing box. This displays the type of character to be entered. Empty spaces are entered by pressing .

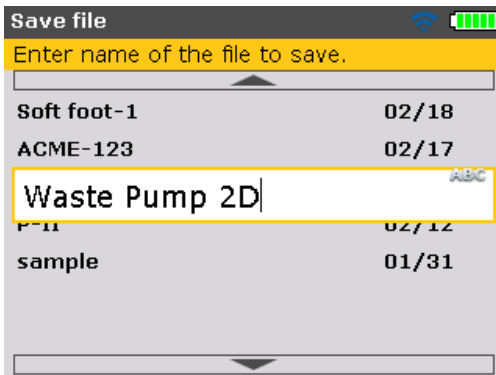

Press  to confirm file name.

When saving an already existing file, the editing box appears with the existing name highlighted. Confirm saving by pressing .

Note

The Product stores up to 200 measurement files.

'New file' – This option is used to create a new measurement file.

'Resume' – This option toggles with 'New file' and is used to call up the last file loaded before the instrument was switched off, depending on the resume policy set.

'Print report' – This option is used to print the measurement report or the soft foot measurement report.

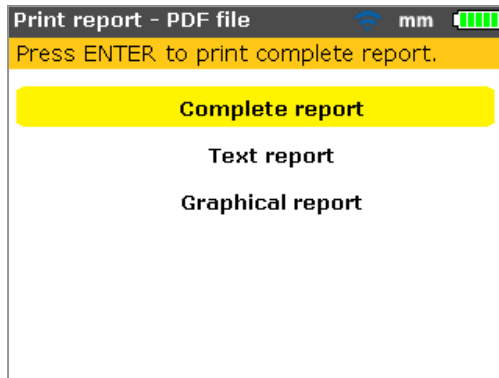

The following report options are available:

- Complete report – this option prints a complete report that includes machine graphics and measurement results in both numerical and graphical format.
- Text report – this option generates reports in text format only.
- Graphical report – reports printed using this option display only graphical representation.

## 6. Getting started

### Set up the product

1. Prepare the machines by making certain that they are locked out, tagged out and all necessary safety precautions have been taken.
2. Mount brackets, wireless module, sensor and prism. The sensor connected to the wireless module should be mounted to the **left machine** (usually stationary).
3. Switch the product on by pressing  and holding down briefly. The right LED lights up followed by a beep. Shortly afterwards, the "Setup" screen appears.

### Enter dimensions

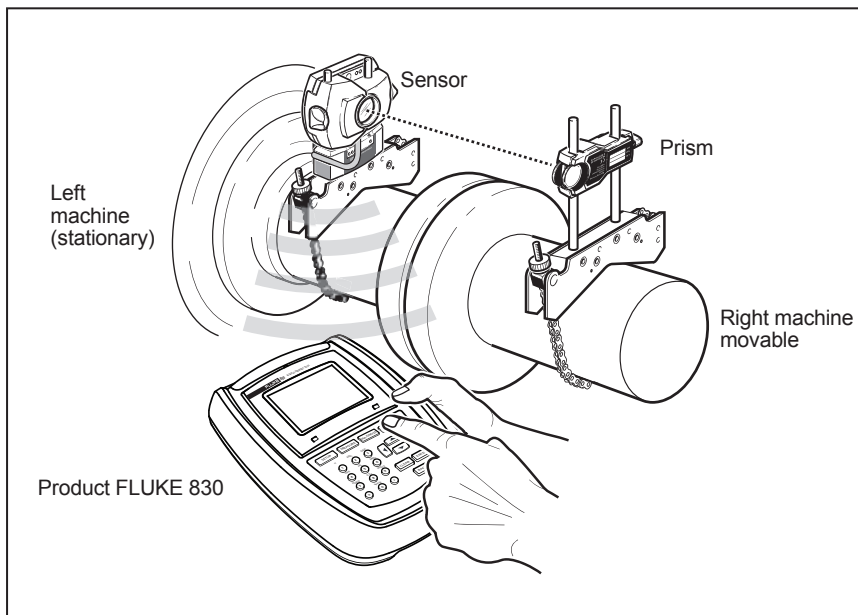
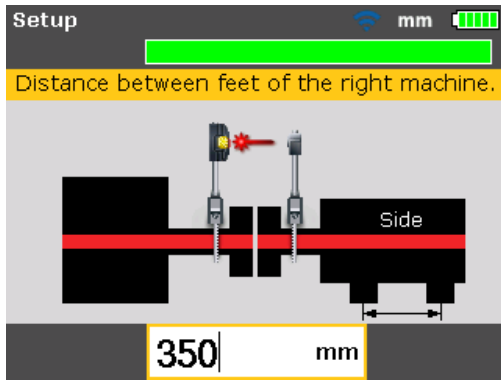

Figure 6-1. Mounting components across the coupling

Use the data entry keys to directly enter all required dimensions.



The editing box and a hint text for the dimension to be entered or edited appears. Use the data entry keys to enter this dimension then press **ENTER** to confirm entry. The dimension arrows advance automatically to the next required dimension, and the corresponding hint text appears. Repeat the procedure until all required dimensions have been entered.

#### Note

*The green bar scale at the top of the screen indicates an incremental progression of current activity – in the above case, entering machine dimensions.*

Dimensions to be entered include:

1. Sensor to prism
2. Sensor to center of coupling
3. Coupling diameter (default is 100 mm / 10")
4. RPM
5. Center of coupling to front foot (right machine)
6. Front foot to back foot (right machine)

After the last required dimension has been entered, the measurement screen appears.

The dimension screen can always be accessed by pressing **SETUP**.



## Wireless measurement

*Note*

*The measurement mode that will be described here is 'Compass' mode. In this mode, measurement points are taken at any 3 of the 8 available sectors. 'Compass' mode and 'Clock' modes are the default measurement modes for horizontal and vertical machines respectively.*

Switch the wireless module on using its little silver toggle switch. This will power the sensor and initialize the laser beam. Center the laser dot on the prism dust cap (see Figure 6-2).

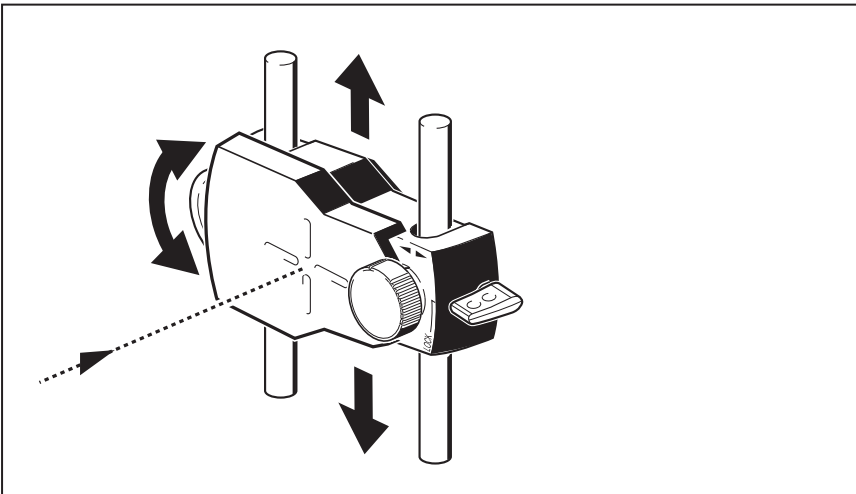

Figure 6-2. Laser dot centered on prism dust cap



Warning

Do not stare into beam.

Press **MENU** then use the navigation keys and highlight the 'Measure options' icon.

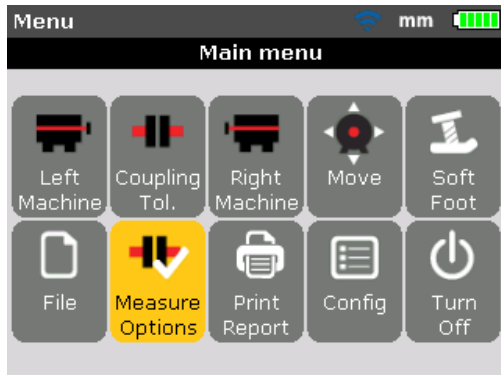

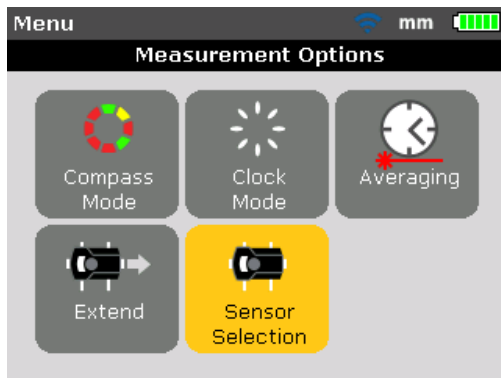

Confirm selection by pressing **ENTER**. The "Measurement options" screen appears.

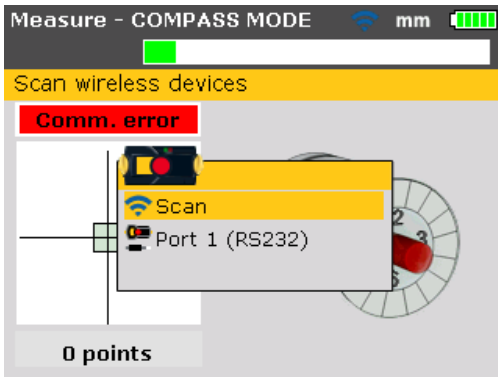

Use the navigation keys and highlight the 'Sensor selection' icon, then confirm selection by pressing **ENTER**.



Use /  and highlight 'Scan' then press  to scan any wireless modules within the neighbourhood.

*Note*

*Make sure the wireless module is switched on.*

Once detected, the wireless module is selected automatically.

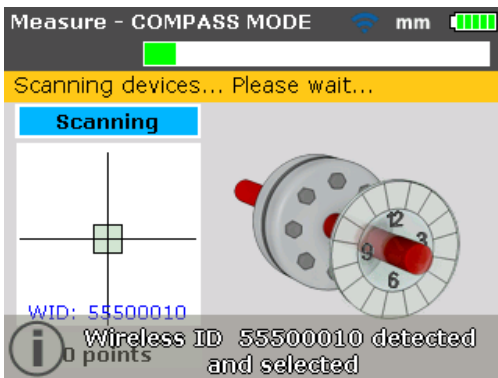

Adjust bracket if necessary to center beam horizontally onto the prism. Tighten bracket. Slide the prism on the support posts to center beam vertically onto the prism dust cap. When centered, remove the prism dust cap. Use the yellow knob to make horizontal adjustments of the reflected laser beam, and the thumbwheel to make vertical adjustments to position the dot at the center of the target square or as near the center as possible.

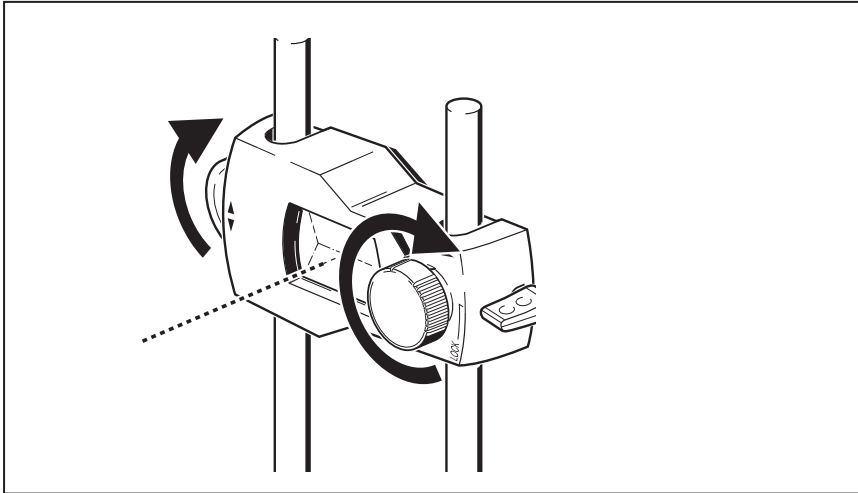

**Figure 6-3. Centering the reflected laser beam using the thumbwheel and the yellow beam adjustment knob**

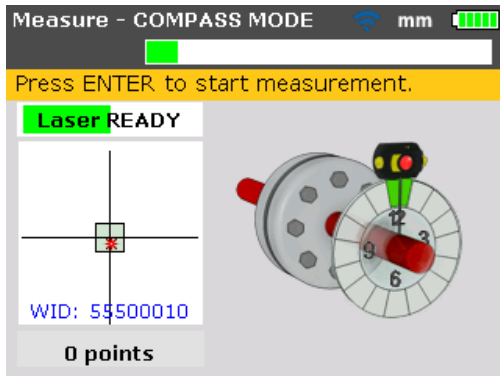

#### Note

When making the above adjustments, observe the product's alignment condition LED and the dot on the display screen. When the LED turns yellow, this is an indication that the reflected beam position is OK and measurement can proceed. When the LED turns green, the dot is centered in the target square.

After centering the laser dot, rotate shaft to the first measurement position. Measurement can only be taken when the sector in which the shaft has been positioned is highlighted green. Press **ENTER** to take the measurement point. The sector is then highlighted orange, an indication that measurement has been taken in that particular sector.

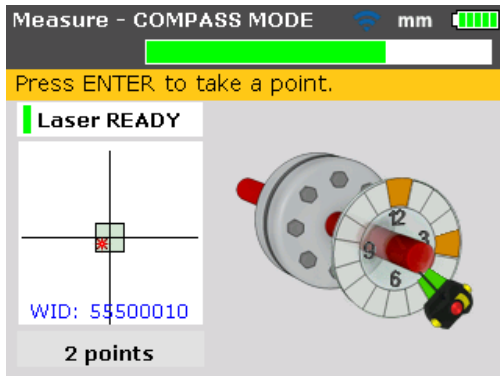

*Note*

*Always turn shafts in the normal rotation direction of the machines.*

Rotate shaft to next measurement position and take point. Readings from any 3 of the 8 available positions (taken in any order) are required for results, which are initiated automatically after the set measurement points have been taken.

## Diagnose

Alignment results with both coupling and feet results are displayed automatically.

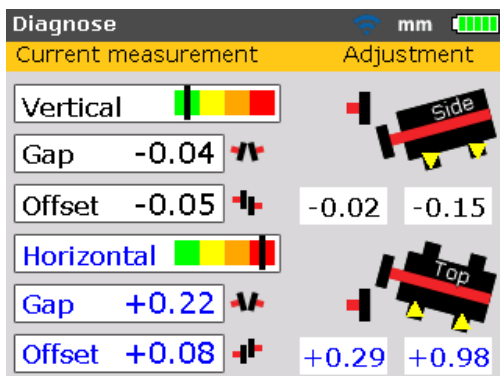

Coupling and feet results are displayed in both vertical and horizontal planes. Coupling results are given in the form of gap and offset. With stationary machine on the viewer's left, gap is positive when open at the top or side away from viewer. Offset is positive when the right coupling half is higher or further away from viewer.

The foot results show the foot correction values relative to the stationary machine. In foot results positive values indicate that right machine is downwards (therefore **add shims** for correction) or towards viewer (therefore **move away** from viewer for correction). Negative values indicate that movable machine is upwards (therefore **remove shims** for correction) or away from the viewer (therefore **move towards** viewer for correction). The alignment tolerance status can be displayed using the tolerances feature.

*Note*

*Tolerance bar is 4-level scale on screen of Product.*

*Alignment condition LED is below screen.*



Tolerance bar is green (alignment condition LED lights up green) – values within excellent tolerances



Tolerance bar is yellow (alignment condition LED lights up yellow) – values in acceptable tolerances



Tolerance bar is either orange or red (alignment condition LED lights up orange or red) – values out of tolerance



## 7. Horizontal machine alignment

### Preparing for the alignment procedure

Before using the Product, prepare the machine for alignment as described below.



**Make sure machines are locked out and tagged out and cannot be started accidentally or deliberately while you are working on them!**

#### **Solid, flat foundation**

A solid, rigid foundation is required to obtain correct, lasting shaft alignment that allows long-term uninterrupted machine service.

#### **Machine mobility**

If the machine to be moved stands directly on the foundations, it cannot be lowered for alignment correction. It is therefore advisable to start with about 2 mm (50 mils) of shims beneath the feet of both machines. Hydraulic or screw-type positioning aids are recommended for horizontal movement.

#### **Rigid couplings**

Rigid couplings must be loosened before measurement so that they do not distort the alignment condition.

#### **Shaft play and coupling backlash**

Axial shaft play of up to 3 mm (1/8") has no adverse effect on the machine diagnosis (but not necessarily for machine operation).

Turning the shaft or coupling end where the prism is mounted, engages the mating parts of the coupling hence reducing the effects of coupling backlash. The sensor measurement principle is also less susceptible to coupling backlash.

#### **Soft foot**

Soft foot causes the machine frame distortion every time the anchor bolts are tightened, making proper alignment difficult or impossible.

#### **Tolerances, thermal growth, alignment targets**

These values can be obtained from the individual machine specifications, and used to specify a position on a shaft centerline and the alignment condition at that position. If a machine set is aligned 'cold', the growth factor at operation must be considered. A misalignment value must be introduced when performing cold alignment.

### Measurement separation

Since the Product requires no mechanical connections (such as cantilevered dial indicator brackets) to span over the coupling during measurement, alignment may easily be performed over large sensor–prism separations.

Note that over very large distances the shafts and coupling may sag, and the machines may need to be deliberately misaligned to take the catenary curve into account, if such sag does not disappear when machines are put into operation. Refer to the machine manufacturer's specifications.

### Check for soft foot

Refer to section on soft foot on page 91.

### Mount the brackets

Mount the brackets on either side of the machine coupling, and both at the same angular position.

Please note the following in order to obtain the highest possible measurement accuracy and to avoid damage to equipment:



**Ensure that the brackets fit solidly onto their mounting surfaces!  
Do not use self-constructed mounting brackets, or modify the supplied original bracket configuration (for example, do not use support posts longer than those supplied).**

### Bracket mounting procedure

To fit the compact bracket chains, refer to the diagrams shown on the next page and follow the instructions carefully.

1. Choose the shortest support posts which will still allow the laser beam to pass over the coupling flange. Insert the support posts into the bracket.

#### Note

*In some cases, if the coupling is large enough, a coupling bolt can be removed and the laser beam shot through the bolt hole, in order to avoid protruding radially beyond the coupling's outer diameter (OD).*



2. Fasten the support posts in place by tightening the hex screws on the sides of the bracket frame.
3. Place the bracket on the shaft or coupling. Wrap the chain around the shaft and feed it through the other side of the bracket: If the shaft is smaller than the width of the bracket frame, insert the chain from the inside of the bracket as shown in Figure 7-1; if the shaft is larger than the bracket width, insert the chain into the frame from the outside.
4. Catch the chain loosely on the anchor peg.
5. Turn the bracket thumbnut to tighten the assembly onto the shaft.
6. Clip the loose end of the chain back onto itself.

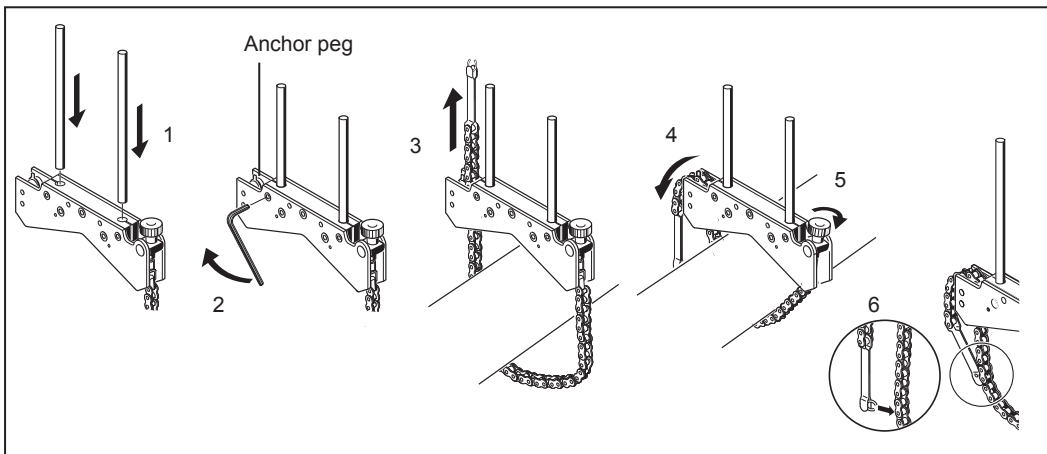

**Figure 7-1. Mounting the bracket step-by-step**

The bracket should now be tight on the shaft. Do not push or pull on the bracket to check, since this could loosen its mounting.

To remove the brackets, loosen the thumbnut, then remove the chain from its anchor peg.

*Note*

*The compact chain-type brackets cover most situations, but in cramped or special cases, the optional compact magnetic bracket may be useful.*

## Mount wireless module, sensor and prism

1. Mount the wireless module on the support posts of the bracket fixed on the shaft of the **left machine** (usually stationary machine) – as viewed from normal working position. The module fastens on the support posts. It is recommended to slide the wireless module all the way down onto the bracket frame (see Figure 7-2).
2. Mount the sensor on the same support posts as the wireless module. Ensure that its yellow knobs are loosened enough to allow the sensor slide onto the support posts. Lower the sensor as close to the wireless module as possible (refer to Figure 7-2).
3. Clamp the sensor onto the support posts by tightening the yellow knobs.
4. Connect the sensor to the wireless module using the wireless module cable (see Figure 7-2).
5. Mount the prism on the support posts of the bracket fixed on the shaft of the **right machine** (usually movable machine) – as viewed from normal working position.

### *Note*

*The yellow knob on the front of the prism allows you to adjust the horizontal angle of the reflected laser beam. Before you mount the prism make sure that this knob is centered to allow for maximum adjustment range later on. The bottom of the knob should be flush with the arrow on the prism housing (refer to Figure 7-3).*

6. Flip up the yellow quick-release lever on the side of the prism housing, then slide the prism onto the right-hand bracket posts. Return the lever to its horizontal position to secure the prism on the posts (see Figure 7-3).

Both sensor and prism should be at the same height, as low as possible, yet just high enough for the beam to clear the coupling flange. They should also visually appear to be rotationally aligned to each other.

Make the final adjustments, loosening the brackets slightly if necessary, then rotating them and re-tightening.

**Horizontal shaft alignment**  
*Mount wireless module, sensor and prism*

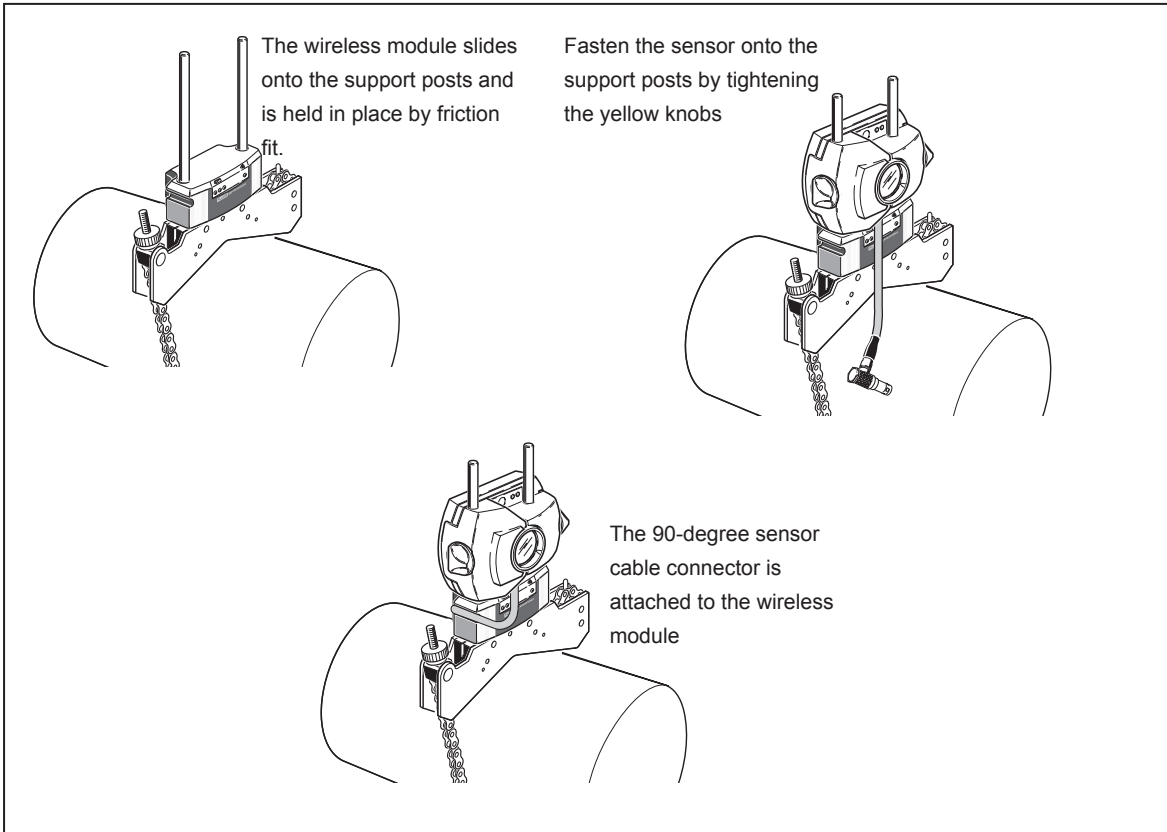

**Figure 7-2. Mounting wireless module and sensor**

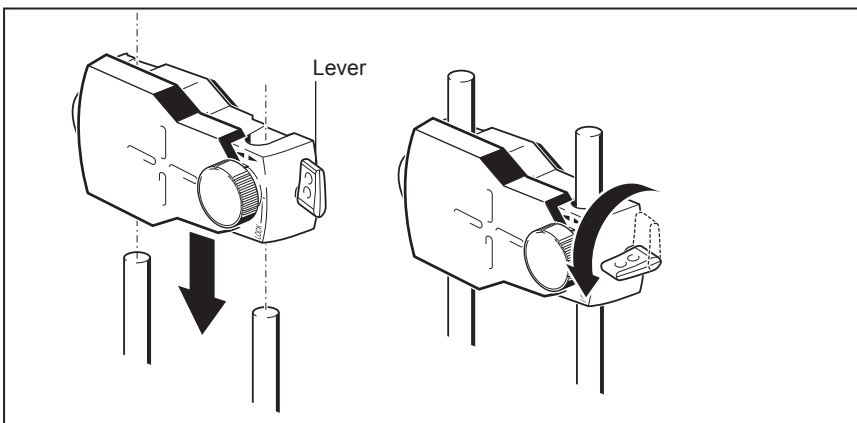

**Figure 7-3. Mounting and fastening prism**

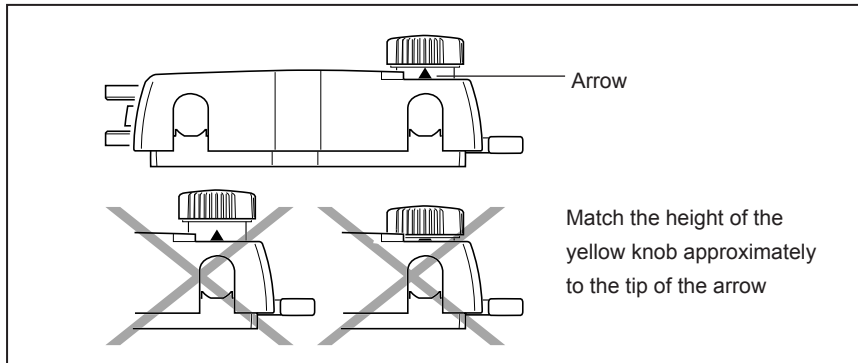

**Figure 7-4. Centering prism knob for maximum adjustment**

Proceed to 'Switch Product on and start application' on page 47.

If using the sensor cable for data transmission, see 'Connect the sensor' below.

## Connect the sensor

### Note

Measurement data may also be transmitted from the sensor to the Product via cable. If using cable and not the wireless module to transmit measurement data, then insert the straight-ended plug of the sensor cable into the Product's blue sensor port (see Figure 7-5).

### Caution

Match the direction arrows on the plug to the white arrow on the blue port to ensure proper plug orientation; otherwise the pins inside the plug may be damaged.

### Note

Instructions on how to replace the wireless module cable with the sensor cable are in the 'Appendix'.

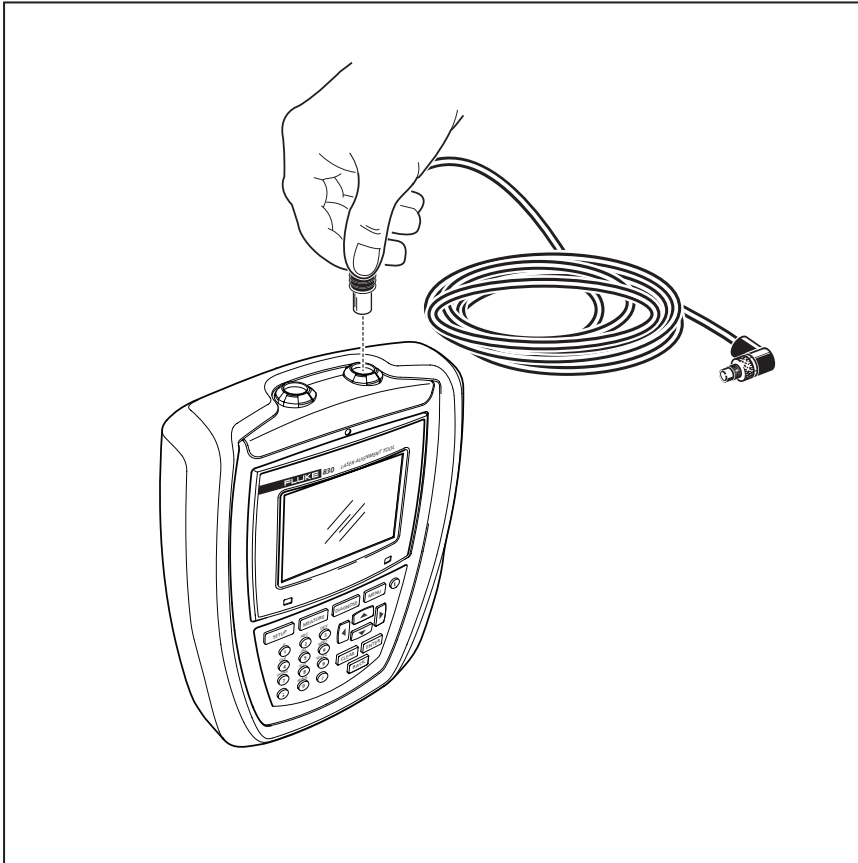

**Figure 7-5. Inserting sensor cable into the alignment tool**

### **Disconnecting the sensor cable**

To disconnect, grasp the ribbed collar of the sensor plug and carefully pull it out of the computer sensor port.

### **Switch Product on and start application**

Press  and hold down for a few seconds. The Product's right LED lights up followed by a beep. Shortly afterwards, the "Setup" screen appears.

## Enter machine dimensions

Machine dimensions are entered using the grey data entry keys.

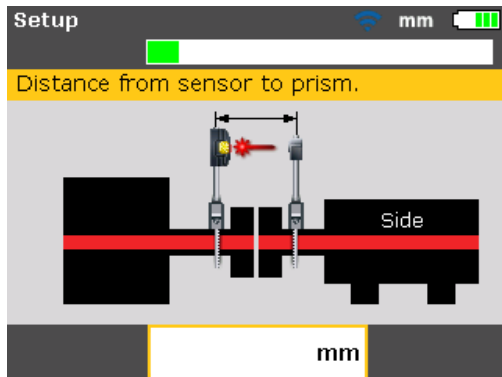

An editing box and a hint text for the dimension to be entered or edited appear on the dimensions screen. The required missing dimensions are entered directly using the data entry keys.

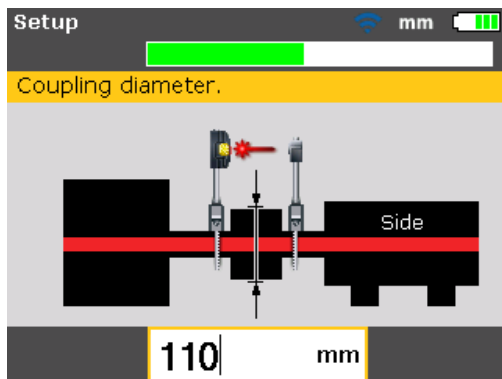

Confirm the entered value by pressing **ENTER**. The dimension arrows advances automatically to the next required dimension.

Enter dimensions as shown in Figure 7-6:

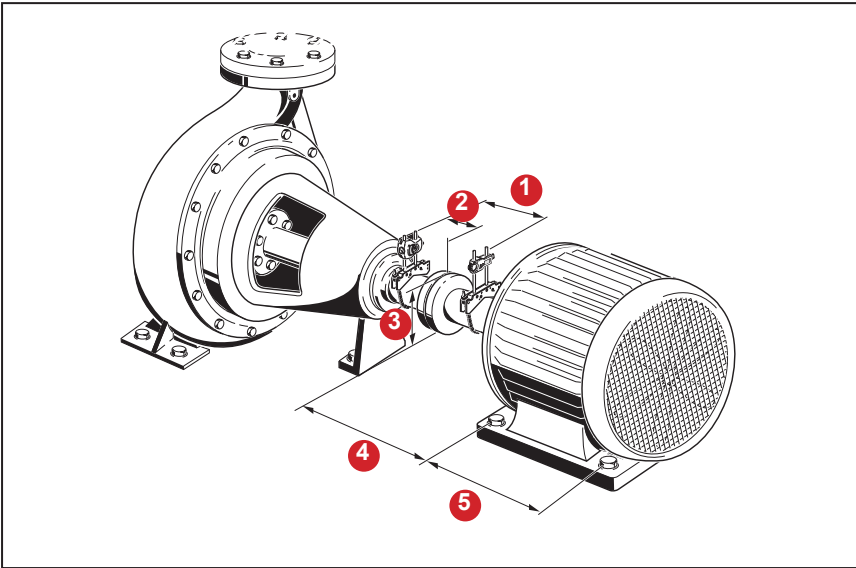
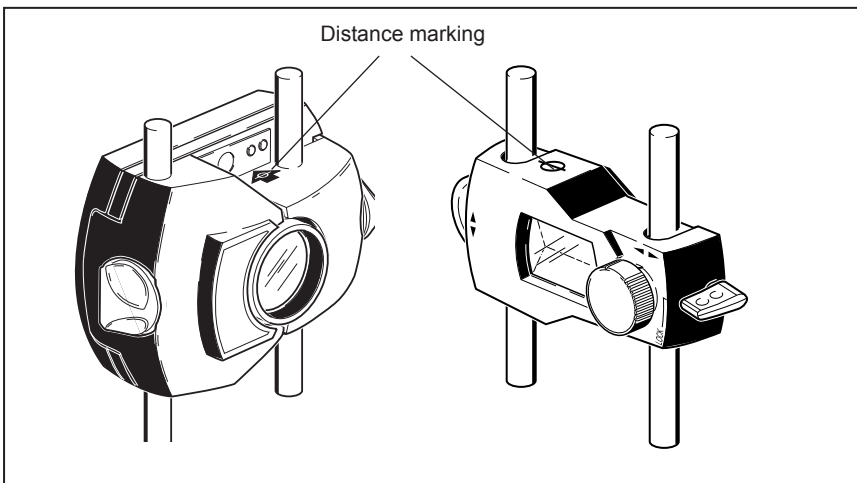

**Figure 7-6. Machine dimensions to be entered**

**Sensor to prism**

**1**

This is the distance between the markings on top of the sensor and the prism (refer to Figure 7-7). The dimension is determined by measuring the distance between the center of the prism and the sensor support posts.



**Figure 7-7. Distance marking on the sensor and prism**

**Sensor to coupling center**

2

This is the distance between the marking on top of the sensor and the coupling center.

This dimension is calculated automatically as half the entered sensor to prism distance. The value may be edited directly in the editing box that appears and value confirmed by pressing .

**Coupling diameter**

3

The coupling diameter can be obtained by measuring the circumference of the coupling and dividing the value by 3.142 ( $\pi$ ).

The default value is 100 mm (10" if set to US imperial customary units). Should there be need to edit the value, use the data entry keys to enter value in the editing box that appears, then confirm entry by pressing . The dimension arrows advance to the next required distance automatically.

**RPM (revolutions per minute)**

The default value is 1500 (1800 if set to US imperial customary units). Should there be need to edit the value, use the data entry keys to enter value in the editing box that appears, then confirm entry by pressing . The dimension arrows advance to the next required distance automatically.

**Coupling center to front foot, right machine**

4

This is the distance from the center of the coupling to the pair of feet on the right machine nearest to the coupling.

**Front foot to back foot, right machine**

5

This is the distance between the front and back feet of the right machine.



**Entering negative dimensions**

In certain circumstances or unusual machine configurations, negative dimensions may also be entered where needed, such as coupling center to front foot (right machine) when this foot is behind the coupling center, or sensor to coupling center if the sensor is mounted on the coupling such that the sensor distance marking is in front of the coupling as shown in Figure 7-8. In the configuration, the dimension sensor to coupling center has a negative value.

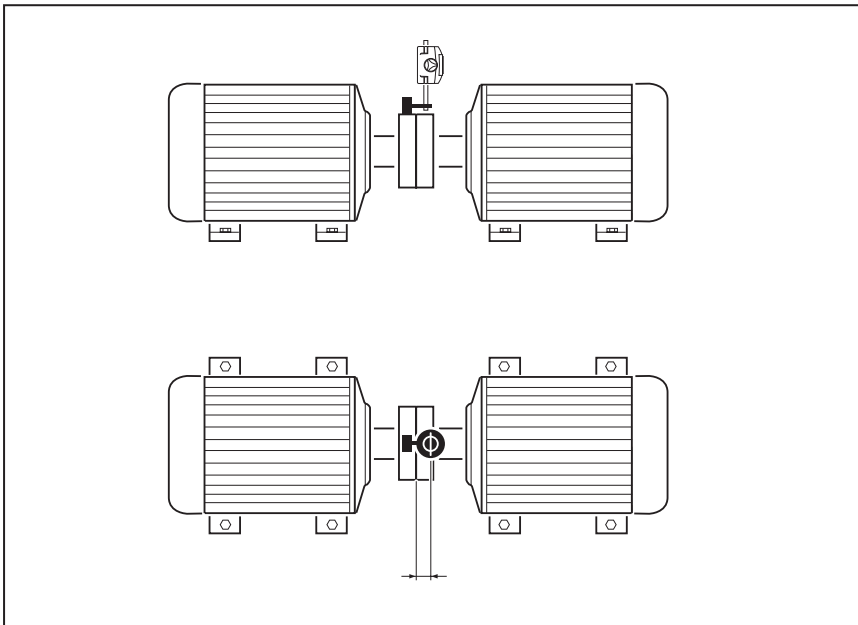

**Figure 7-8. Distance marking on the sensor**

## Machine set-up

Machine properties may be set via the menu items 'Left machine' or 'Right machine'. The menu screen is accessed by pressing **MENU**.

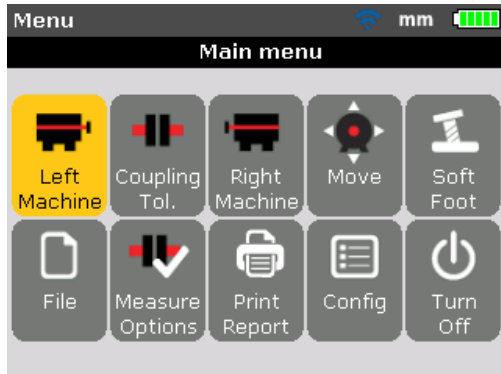

Use the navigation keys and highlight either 'Left machine' or 'Right machine' icon. Pressing **ENTER** with the left or right machine icon highlighted, reveals the machine properties that may be edited.

### Machine properties

With 'Left machine' icon in the "Menu" screen highlighted, pressing **ENTER** reveals the machine parameters that can be edited.

#### Note

*In the following example, the left machine is initially designated stationary.*

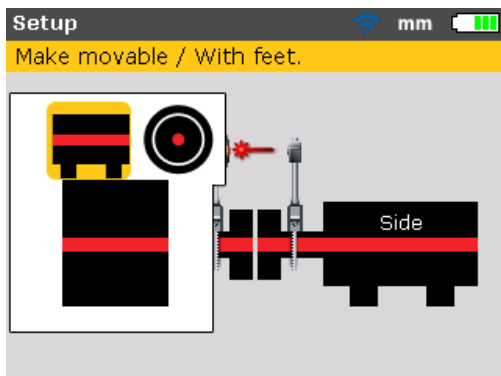

Machines may be designated either stationary or movable or the flange position can be defined.

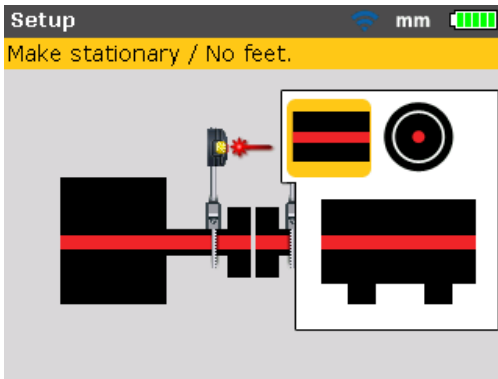

Use **▶**/**◀** to highlight machine parameter to be changed and confirm selection by pressing **ENTER**.

### Coupling tolerance table



With 'Coupling Tol.' icon highlighted, pressing **ENTER** reveals the coupling tolerance table.

The screenshot shows a 'Tolerance table' screen with a yellow header bar containing the text 'Press ENTER to disable tolerances.' Below the header is a table with the following data:

Diameter: 100 mm		Enabled [mm]	
RPM	Acceptable	Excellent	
750	Gap: 0.13 Offset: 0.19	Gap: 0.09	Offset: 0.09
1500	Gap: 0.07 Offset: 0.09	Gap: 0.05	Offset: 0.06
3000	Gap: 0.04 Offset: 0.06	Gap: 0.03	Offset: 0.03
6000	Gap: 0.03 Offset: 0.03	Gap: 0.02	Offset: 0.02

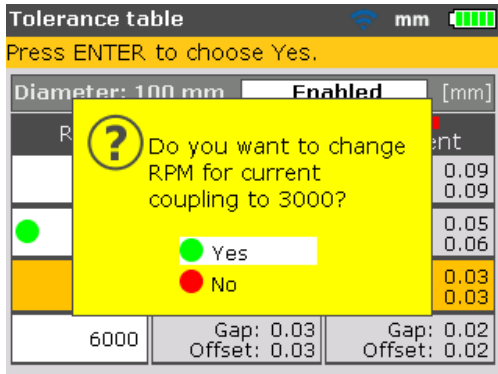
The highlighted RPM is the value entered in the "Set-up" screen. A different RPM value may be set from the "Tolerance table" screen. Use the navigation keys and highlight the desired machine RPM value, then press **ENTER**. A hint requesting confirmation of RPM change appears on the display.



Use  /  and highlight 'Yes' then confirm selection by pressing . The new RPM value overrides the value initially entered during set-up. Coupling tolerances will now be based on this accepted RPM value.

## Laser beam adjustment

After entering all required dimensions, the measurement screen appears automatically.

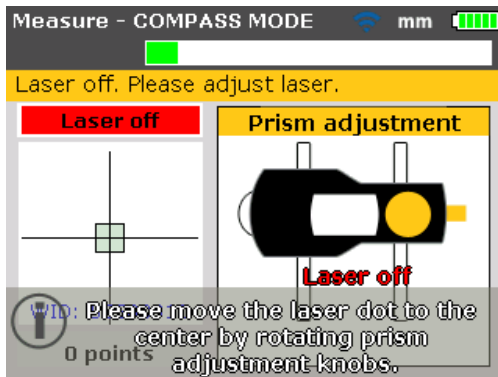

Switch the wireless module on using the little silver toggle switch found in the back on the right side. The battery status LEDs blink for three seconds. The module is now ready for operation. It activates the laser, if the wireless module is connected to the sensor.

If using the RS232 interface, the laser is activated when the straight-ended plug of the sensor cable is inserted into the Product's blue sensor port.

The sensor and prism need to be adjusted so that the laser beam strikes the prism and is reflected back into the sensor.

## Remove sensor cap



**Do not stare into beam.**

The laser beam is now on! Leave the prism cap on. When the beam strikes the cap it should be readily visible. Should the beam be so far off target that it misses the prism completely, hold a sheet of paper in front of the prism to try and locate the beam.

## Adjust beam onto prism cap

With the prism dust cap still in place, adjust the beam onto the center of the target (refer to Figure 6-2):

- To adjust vertically slide the prism and/or sensor up and down along the support posts. Use the thumbwheel on the side of the prism housing. To move the sensor, loosen the yellow knobs.
- To adjust horizontally you will have to loosen one of the brackets on the shaft and rotate it slightly. Retighten.

## Remove prism cap and establish communication between the sensor and the Product

The Product collects measurement data using either the wireless module or via the sensor interface.

Remove the prism dust cap to allow the beam to strike the prism and be reflected back to the sensor, and then press **MENU**. The “Main menu” window opens. Use the navigation keys and highlight the icon ‘Measure options’.

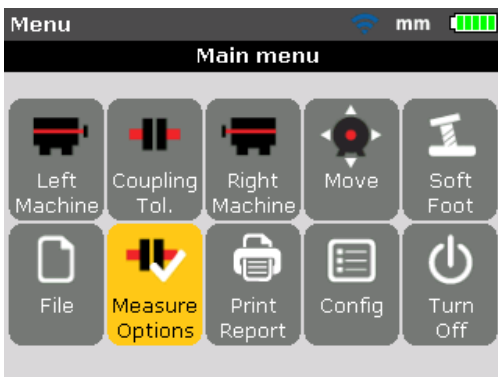

Press **ENTER** to confirm selection. The “Measurement options” window opens. Use the navigation keys and highlight the icon ‘Sensor selection’.

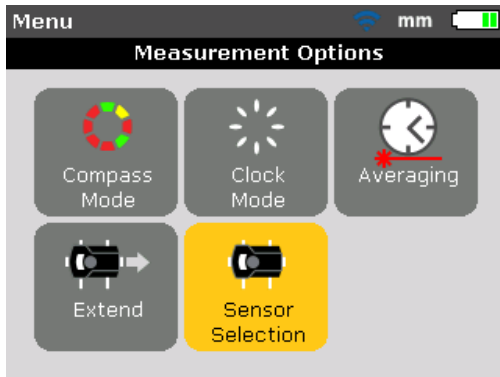

Confirm selection by pressing **ENTER**. The selection window appears.

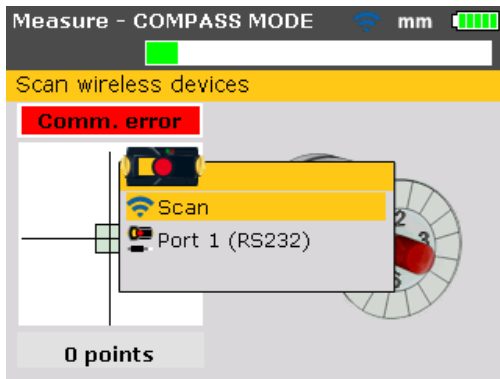

Use either **▲** or **▼** and highlight 'Scan' then press **ENTER** to scan wireless modules within the neighbourhood. Once detected, the module is automatically connected and communication established between the sensor and the Product. If using the sensor interface, use either **▲** or **▼** and highlight "Port 1 (RS232)". Press **ENTER** to confirm selection, and proceed with laser beam adjustment.

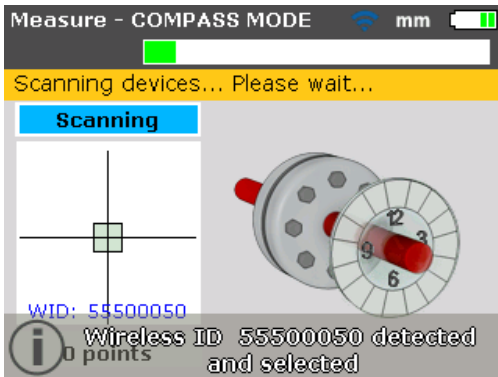





**Note**

The serial number of the wireless module in use is displayed on the screen during measurement.

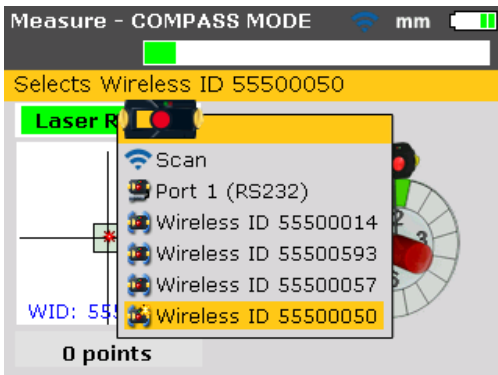
Now proceed with laser beam adjustment.

All detected wireless modules are remembered by the Product, and are displayed when 'Sensor selection' is selected.



In this case, the desired wireless module is highlighted using either  or  then pressing  to confirm selection.

It may be necessary to delete some of these entries as they could no longer be in use. To delete unwanted entries, access the 'Sensor selection' menu. Use the navigation keys to highlight the wireless module to be deleted and press **CLEAR**.

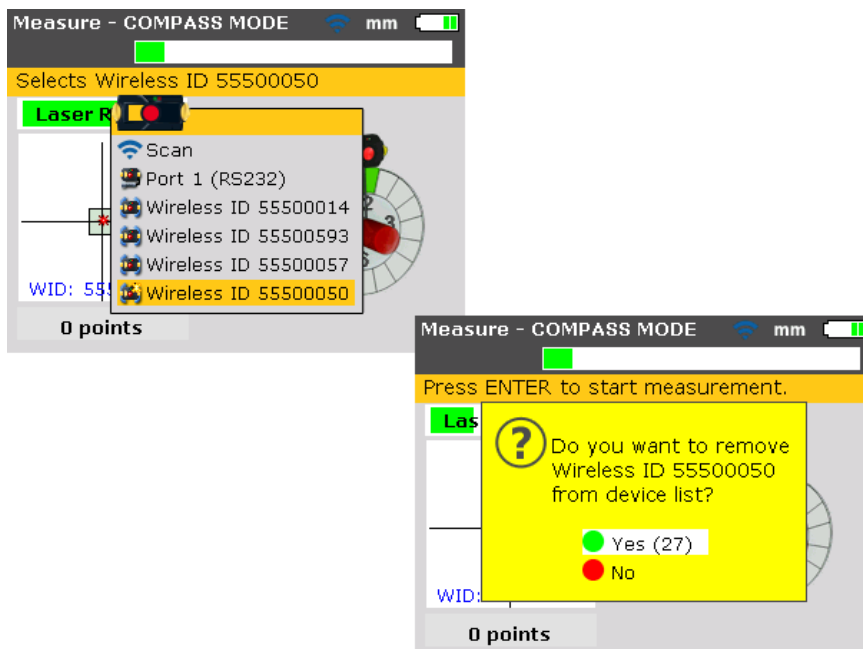

Wireless modules deleted are remembered if detected during scanning.



**Adjust prism until ONLY the GREEN sensor LED lights constantly,  
the Product's right LED turns blue**

The sensor has a red and a green LED to indicate the beam adjustment condition. This condition is simultaneously monitored on the Product's alignment condition LED (right LED).

*Note*

*Make sure that the prism and sensor lens are clean. Use a soft lint-free cloth. A lens cleaning cloth is supplied.*

When the reflected beam fails to strike the detector surface, the Product's right LED turns red while the red sensor LED blinks quickly (0.3 s). The message 'Laser OFF' appears on the display screen. Adjust the reflected beam using the prism metal thumbwheel and the yellow adjustment knob on the prism as shown on Figure 7-9. As the reflected beam strikes the edge of the detector, the Product's right LED turns orange with the red sensor LED still blinking quickly. The message 'Laser End' appears on the display screen.

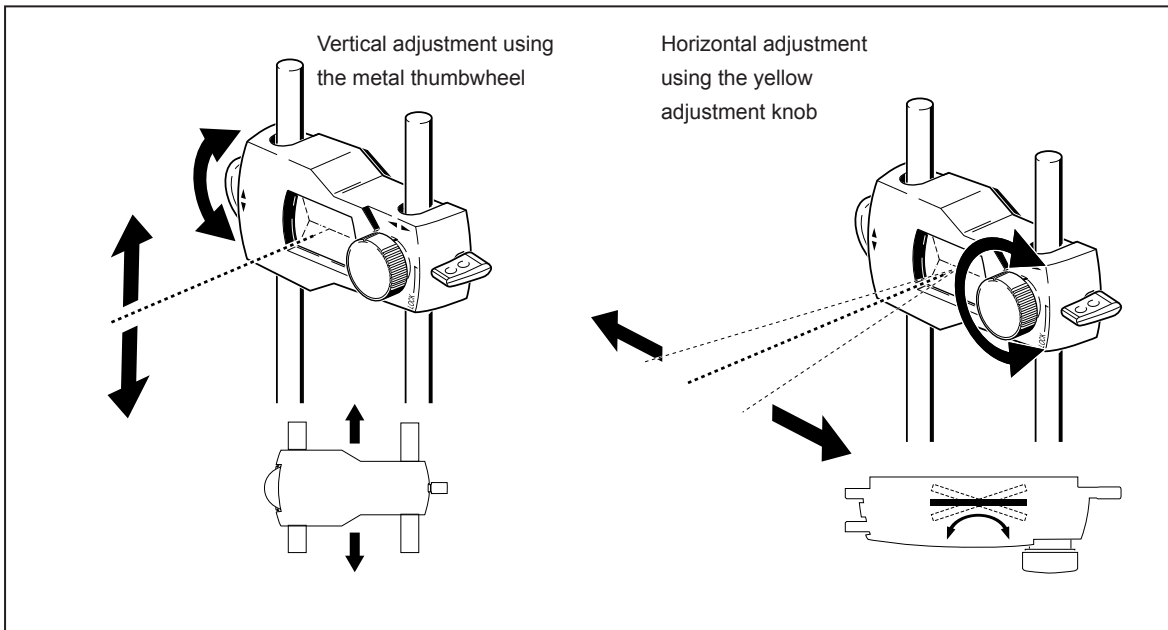

**Figure 7-9. Horizontal and vertical adjustment of the laser beam**

### Center beam such that the Product's right LED turns blue

Adjust the laser beam such that the laser dot on the display screen is positioned in the green square in the center of the detector display.

- Horizontal adjustment with yellow prism knob
- Vertical adjustment with the side metal thumbwheel.

The Product's right LED turns blue.

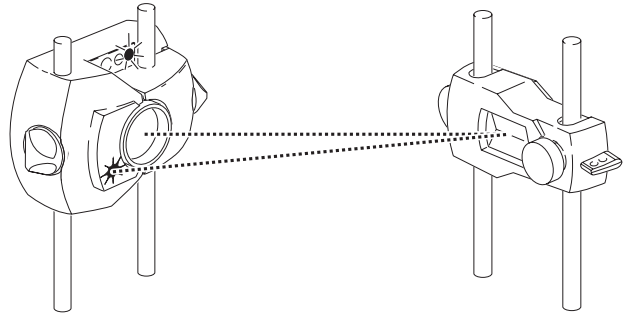
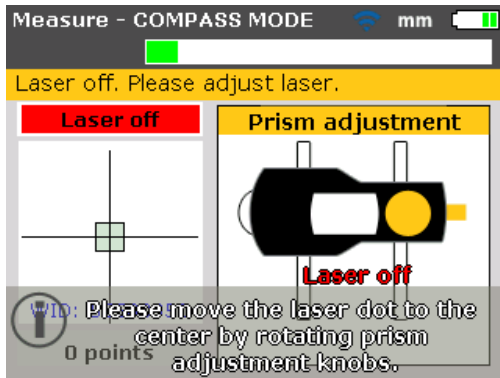

RED sensor LED blinks quickly while GREEN is OFF and Product's RIGHT LED turns RED

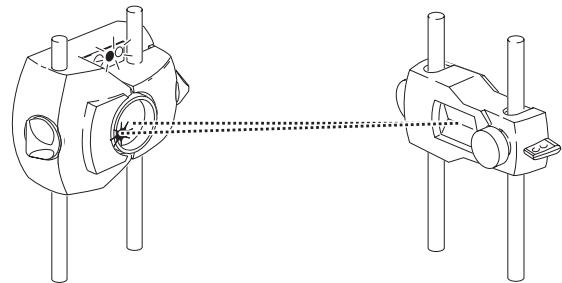
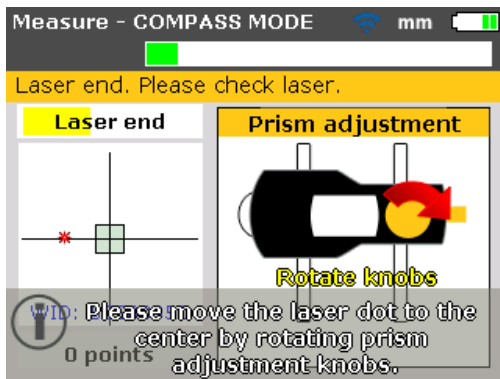

Both sensor LEDs blink quickly and alternately, and the Products RIGHT LED turns ORANGE

## Horizontal shaft alignment Laser beam adjustment

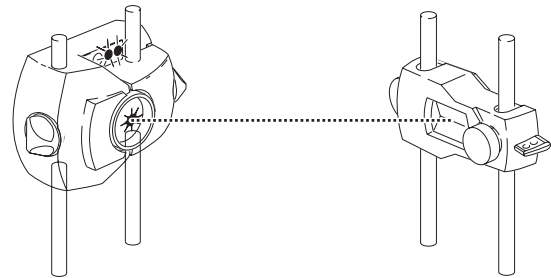
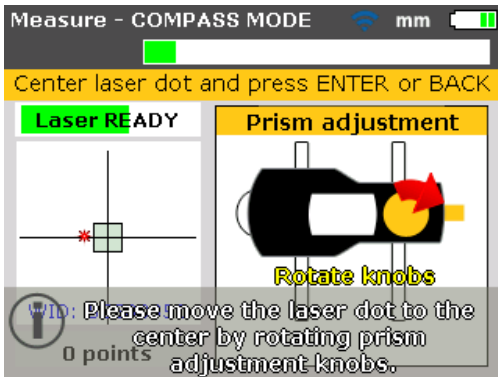

GREEN sensor LED blinks slowly and the Product's RIGHT LED turns GREEN

### Note

The red arrow on the yellow knob assists the user by indicating which way the knob should be turned. The closer the beam comes to being centered, the smaller this arrow becomes

When the laser beam is inside the center square, the GREEN sensor LED lights constantly.

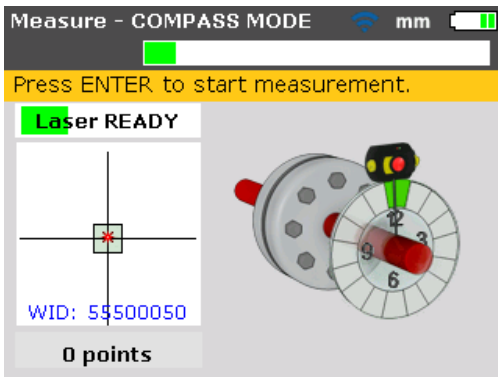

The RIGHT LED turns BLUE

### Note

The beam does not have to be exactly at the center of the crosshair, as this will not affect measurement accuracy. However, maximum range for measurement is available when the beam is well centered.

### Note

Once centered, the sensor and prism must not be touched, as any movement during measurement will be interpreted as misalignment. These components may however be moved when extending the measurement range.

## Take measurements

It is important to note which measurement mode is best suited for a particular application. The table below gives a guide as to which measurement mode is ideal for which measurement.

**Table 7-1. Measurement mode and relevant applications**

Measurement mode	Application
Compass mode	Horizontal machines (standard, uncoupled shafts, nonrotatable shafts)
Clock mode	Vertical machines (four feet or flange-mounted)

When the laser beam is centered such that the dot on the display screen is at the center of the crosshair, the Product's right LED turns blue.

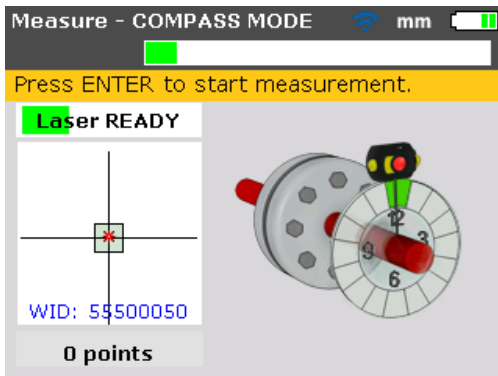

### Note

Compass mode is the default measurement mode for horizontal machines. In this mode, measurement points are taken at any three of the eight available sectors.

### Note

Clock measurement mode which is the default for vertical machines, is described in chapter 9 'Vertical shaft alignment' starting on page 107.

### Note

If coupling torsion play (backlash) is suspected, turn the shaft or coupling end where the prism is mounted. Ensure shaft is turned in the normal rotation direction of the machine.

## Turning shafts

To measure, rotate shaft to the first measurement position. Measurement can only be taken when the sector in which the shaft has been positioned is highlighted green. Press **ENTER** to take the first measurement point. The sector is then highlighted orange, an indication that measurement has been taken in that particular sector.

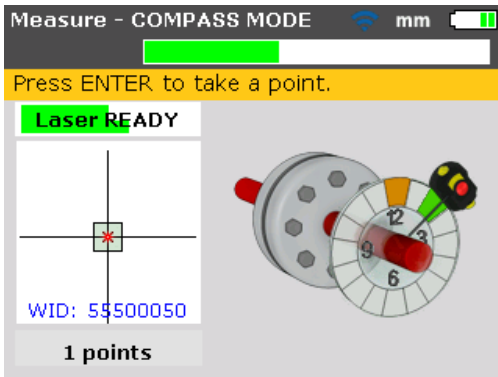

After taking point, rotate shaft to next measurement sector and repeat the step above.

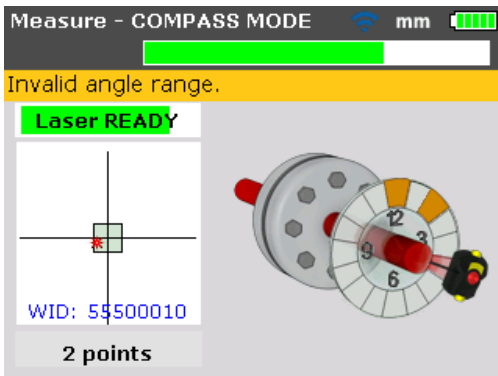

If the sensor rotational position is such that the sector is highlighted red, measurement cannot be taken at this angular position.

### Note

*In Compass mode, the electronic inclinometer in the sensor is active and automatically determines the rotational angle of the shaft, eliminating human error.*

### Note

Remember not to touch mounted components! This includes the brackets and the support posts, which are NOT to be used to rotate the shafts .

It is advisable to turn shafts in the same direction as the machine normally rotates, in case the shafts shift from their normal seating in the bearings.

You may begin measurement by turning the shafts even if the beam is not centered exactly at the center of the crosshair.

### END or OFF? Extend

If 'Laser END' or 'Laser OFF' appears on the screen during the turning of the shafts, the laser has shifted away from the detector due to gross or large misalignment or long beam travel. If this happens, then use the 'Extend' function to expand the measurement range. This function is described on page 102.

### Diagnose

The diagnosis is prompted automatically after the set number of measurements points have been taken.

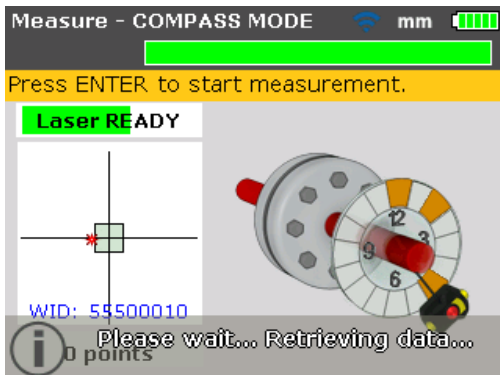

## Alignment condition in both vertical and horizontal directions

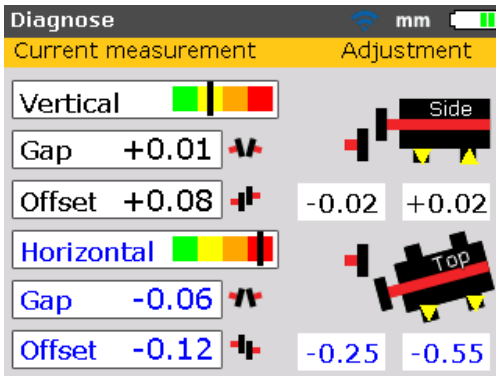

The coupling diagnosis is given in the form of gap and offset values in both vertical and horizontal directions. The true gap being the difference in gap between the coupling faces top to bottom (vertical) or side to side (horizontal) at the diameter that was entered. Offset is the distance between two centerlines at the transmission plane of the coupling.

The foot correction values are shimming or move values, and are either positive or negative. In vertical results, positive foot values indicate raising machine foot by the displayed value. In horizontal results, positive foot values indicate moving the machine away from the viewer by the displayed value.

### Note

#### Sign convention

*Gap is positive when open at top or side away from viewer. Offset is positive when machine to be moved is higher or further from viewer.*

*Positive foot correction values indicate that movable machine has to be moved upwards (**add shims**) or away from the viewer.*

*Negative foot correction values indicate that movable machine has to be moved downwards (**remove shims**) or towards viewer.*

If all four coupling values are within tolerance, you do not need to align the machines. If no in-house standards or specifications from the coupling or machine manufacturer are available, the alignment condition LED and the tolerance bar provide a tolerance check based on the built in tolerance tables. If the measured alignment falls within acceptable tolerance, the LED turns yellow. The LED turns green when the measured alignment falls within excellent tolerance. The LED turns orange when alignment is out of tolerance. A worsening of the misalignment results in the LED turning red.

If the coupling diagnosis show that misalignment exceeds the tolerance, then the machine must be realigned by shimming vertically and repositioning the machine horizontally.

### Tolerances

The color-coded tolerance bars on the results screen indicate the degree to which the measured alignment condition meets specified tolerances. The marking on the tolerance bar shows the measured alignment condition. This ranges from excellent tolerance to worse tolerance.



Figure 7-10. Tolerance bar

The Product's alignment condition LED provides additional information on the tolerance status.

Table 7-2. FLUKE 830 alignment condition LEDs

Tolerance	Tolerance bar	LED color	
Excellent tolerance	<span style="color: green;">■</span>	Green	
Acceptable tolerance	<span style="color: yellow;">■</span>	Yellow	
Out-of-tolerance	<span style="color: orange;">■</span>	Orange	
Grossly misaligned	<span style="color: red;">■</span>	Red	



## **Tolerance table**

### *Note*

*Suggested alignment tolerances are based upon experience and should not be exceeded. They are to be used only if existing in-house standards or the manufacturer of the machine or coupling prescribe no other values.*

The tolerance table is accessed as described under 'Coupling tolerance table' on page 59 and is valid for standard equipment running between 600 – 7200 RPM.

## **Align machine**

### *Note*

*If measured machine alignment is in tolerance (the marking on the color-coded tolerance bar is on either the green or yellow section, and the Product's alignment condition LED lights green or yellow respectively), there is NO need to align the machines. If the alignment is out of tolerance, machines may be aligned by proceeding as described below.*

To align your machine you need to move it vertically by shimming the feet, and horizontally by shifting it sideways.

## **Shim first**

### *Note*

*It is recommended to perform vertical corrections first, since the horizontal condition is easily affected by the process of loosening anchor bolts and inserting/removing shims, whereas the vertical condition is less prone to being affected when performing horizontal moves. You may need to recheck soft foot before proceeding.*

## **Preparation**

To shim the machine successfully, ensure the following:

1. The foot bolts are clean, intact and removable.
2. Soft foot has been eliminated. (Refer to page 91.)
3. The feet have enough shims under them should lowering the machine be necessary.
4. Good quality shims are recommended.

**Loosen bolts**

Avoid moving the machine horizontally. If any foot comes off the ground when loosened, suspect soft foot.

**Shim feet accordingly**

Shimming usually involves the jacking up of the machine and inserting or removing shims of known thicknesses. (Some shims have the thicknesses indelibly etched on them.)

Use the vertical foot correction values to shim BOTH front and back feet as required. Negative feet correction values indicate that the respective machine feet are high and therefore shims should be removed, while positive foot correction values suggest addition of shims.

*Note*

*Vertical shimming can also be carried out using live vertical Move.*

**Retighten bolts**

The machine should now have good vertical alignment.

**Re-measure**

Re-measure to verify vertical alignment results and determine the exact alignment condition.

**Horizontal live Move**

Horizontal Move is used for the lateral positioning of the machine. This used to be done with a dial gauge at the machine feet, but with the 'Move' function, live horizontal movement is viewed on the display screen.

### Start live horizontal Move

While in results screen, press **ENTER** or **MENU**. The “Main menu” window opens.

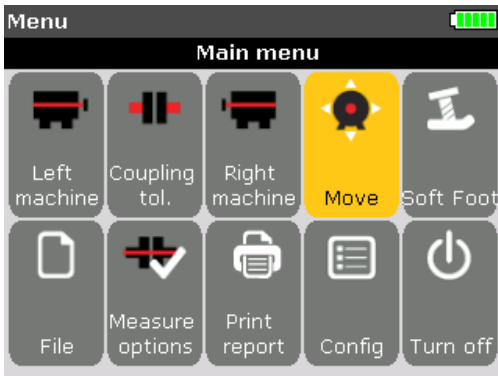

Use the navigation keys and highlight the ‘Move’ icon then press **ENTER** to confirm selection. The screen used to position the sensor in any of the four appropriate 45° positions appears.

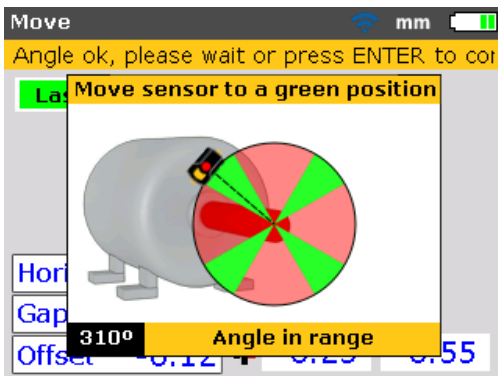

### Turn shafts to any 45° position

Rotate the shaft to any 45° position (this could be either the 10:30, 1:30, 4:30 or 7:30 o'clock position as viewed towards sensor).

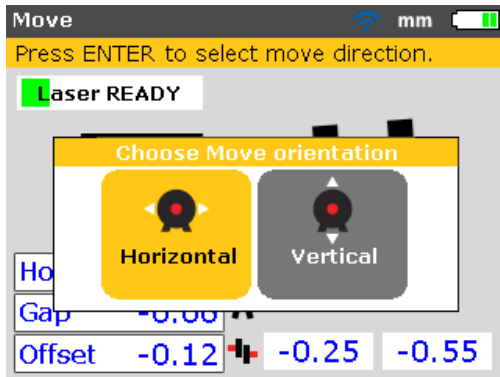

If the laser beam has been centered, rotating the shaft to an angular position corresponding to any of the four green sectors prompts the Move direction dialog window.



Use either  or  to highlight “Horizontal” for horizontal machine movement. Confirm selection by pressing . Live Move starts as soon as the direction of movement has been confirmed.

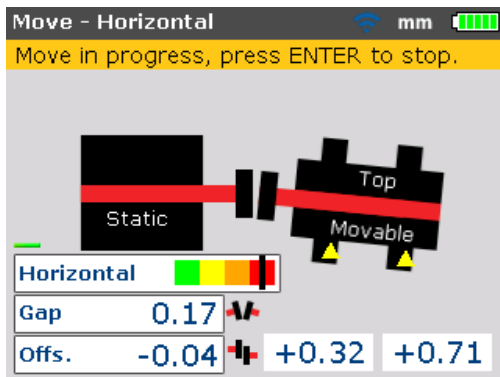

### Loosen bolts and move machine as required

After loosening the anchor bolts, move the machine feet in the direction of the apex of the yellow triangles, keeping an eye on the marking on the color-coded tolerance bar. Watch the display screen carefully to ensure that machine end and direction moved are correct. The marking on the color-coded tolerance bar and the Product’s right LED also give an indication of the alignment status as the machine is moved. (Refer to the tolerances table on page 133.)



**Caution**

**Do NOT attempt to move the machine using heavy sledgehammer blows. This can cause bearing damage, and also produce inaccurate Move results. Jack bolts on the feet or other mechanical or hydraulic devices are recommended for moving machines.**

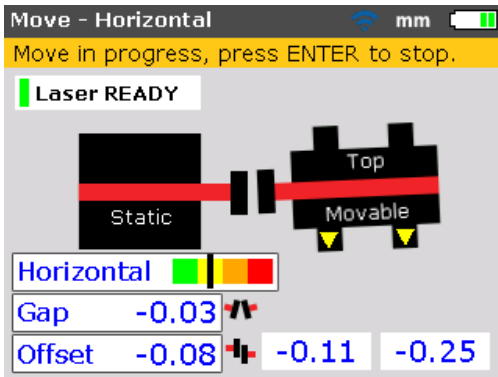

When the marking on the color-coded tolerance bar is on either the green or yellow section, the alignment condition is within tolerance. Proceed to tighten the anchor bolts.

### Tighten the anchor bolts

Tighten anchor bolts, then press **ENTER** or **BACK** to recheck the alignment condition after Move.

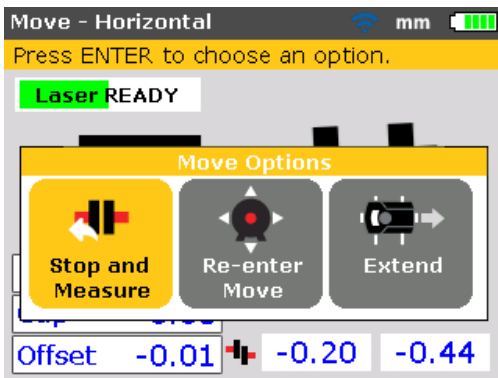

If machine moves while tightening correct soft foot first and also check for a cocked anchor bolt and dished washer, then realign.

### Re-measure after Move - machine in tolerance?

Since the machine has been moved, earlier results are no longer valid. With 'Stop and Measure' highlighted after Move is completed, press **ENTER** to confirm selection. On confirmation, the measurement mode is initialized. If necessary, center laser beam and take another set of measurements. If the diagnosis is within required tolerance, then the machines are aligned.

## Saving data and printing

(Refer to page 81.)

## Finally

Switch the Product off, and then remove the components from the shafts, and store them in the case.



**Warning**

Replace guards before you switch the machine back on.

## Vertical live Move

*Note*

*As it is recommended to first shim, and then move the machine laterally, the vertical live Move function may be used to carry out the shimming.*

For vertical live Move repeat all steps starting from 'Start live horizontal Move' (on page 75) through to 'Loosen bolts and move machine as required' (on page 76) but with reference to the vertical foot corrections. In this case, shimming as required.

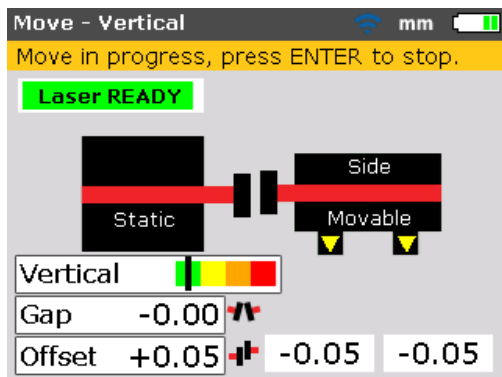

### **Points to observe during the Move**

Closely observe all the following points:

#### **Have shafts accidentally moved (rotated)?**

The shafts, sensor and prism MUST remain steady during the entire Move procedure.

Should the shaft move from the set 45° green sector while in Move, the angle selection screen comes up indicating the angle to which the shaft has rotated.

The shafts must be rotated back into the narrow green sector.

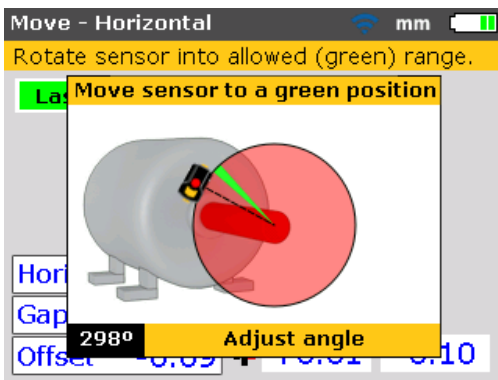

#### *Note*

*Live Move resumes automatically when the shafts are rotated back into this sector.*

#### **END or OFF? The 'Extend' function**

If END or OFF appears on the screen during machine Move, then the laser beam has shifted out of detection range due to gross misalignment or long beam travel. In this case, the measurement range can be extended as described on page 102.

#### **Nearing zero : watch the mark on the color-code tolerance bar and the Product's alignment condition LED**

Proceed towards zero at both machine ends until the marking lands in the yellow section of the tolerance bar. As the machine position moves towards zero, the Product's right LED changes from red (worse) to orange (bad) to yellow (acceptable) to green (excellent).

**Soft foot**

If the machine suffers from excessive soft foot, the Move function may be hampered by the fact that the machine changes its position on its own every time the bolts are loosened and tightened. Correct this problem before aligning. (Refer to page 92.)

**If poor repeatability is experienced**

Possible causes include:

- Incorrect or loose bracket mounting
- Significant shaft bearing play or coupling backlash
- Soft foot can cause positioning errors that make repeat measurement necessary
- Loose anchor bolts
- Yellow knobs on sensor loose, or prism not locked
- Sensor is mounted incorrectly or upside down
- Mounted components moved during shaft rotation
- Temperature changing: machines may have recently shut down
- Uneven shaft rotation
- Vibration



## Saving data and printing

Before switching off the instrument, dimensions, measurements, diagnosis and all settings can be saved for analysis, future use or record purposes in the instrument's non-volatile memory. Full file names with up to 32 alphanumeric characters are possible.

### Note

*The length of the file name is limited depending on whether upper or lower case letters have been used.*

### To save a file

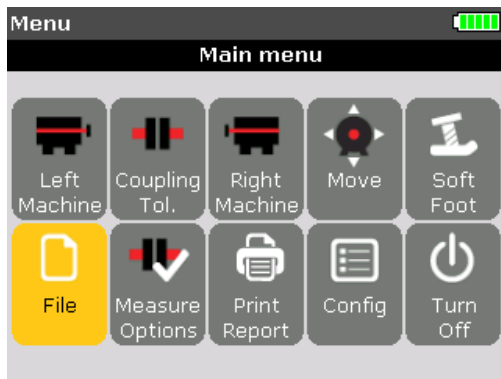

The current measurement file can be saved at any time. To save the file, press

**MENU** then use the navigation keys to highlight the 'File' icon.



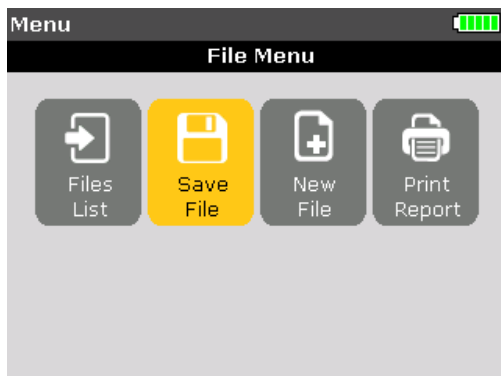

Press **ENTER** to confirm selection. The "File menu" screen appears.



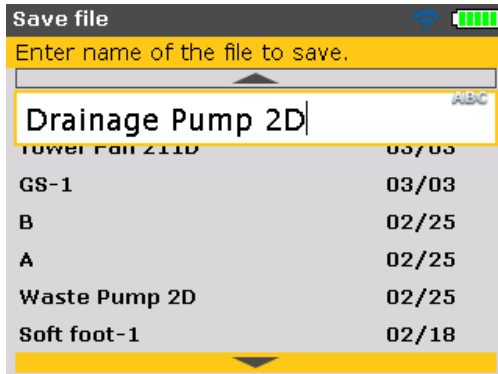

Use   and highlight the “Save file” icon then confirm selection by pressing . An empty editing box appears within the “Save file” screen.



When entering names that contain both upper and lower case characters as well as numerals, use  to cycle through the three options. Press and hold down  while observing the status indicator at the top right corner of the editing box. This displays the type of character to be entered. Empty spaces are entered by pressing .

Use the data entry keys to enter the file name and confirm entry by pressing



Measurement files may also be saved from the “Diagnose” screen after measurement has been carried out. With the diagnosis displayed, press either  or . From the “Main menu” screen that appears, proceed to save the measurement file as previously described. If however, the file had been previously saved, the editing box appears with the file name highlighted within the box.

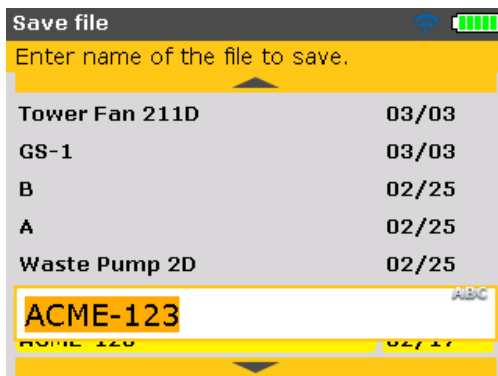

In this particular example, the file “ACME-123” had previously been saved and therefore the name appears highlighted in the editing box.

Press **ENTER** to save the measurement results under the displayed file name. A hint requiring confirmation whether to overwrite the existing file appears.

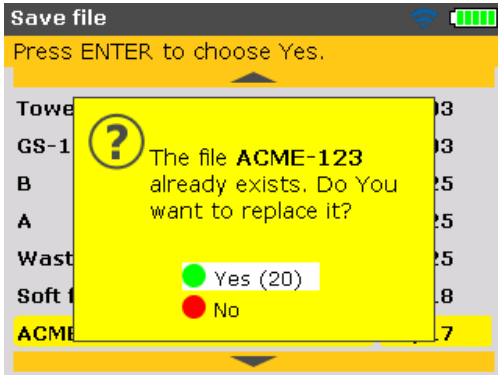

Overwriting the existing file ensures that the measurement file is saved together with the latest alignment results.

*Note*

*It is good practice to always have the current measurement file.*

Use **▲**/**▼** to select 'Yes' then press **ENTER** to overwrite the existing file.

## Printing reports

Using the default printer type 'PDF file', measurement reports may be saved directly to the connected USB memory stick as a PDF, and then printed from any configured printer.

Reports can also be printed directly from the Product to a printer. This is done using the USB cable and the printer USB cable (supplied with the printer or readily available in most electronics stores).

Measurement reports may be printed in a variety of ways.

To print the current measurement report, press **MENU** then use the navigation keys and highlight the 'Print report' icon.

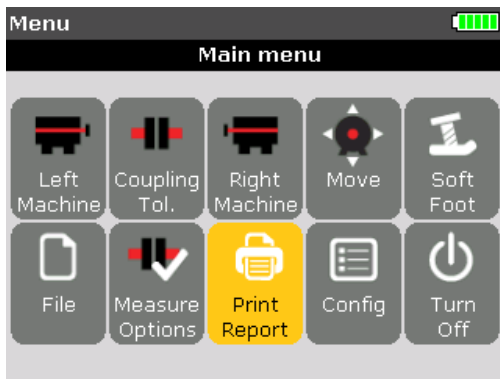

Press **ENTER** to confirm selection. The "Print report" screen appears.

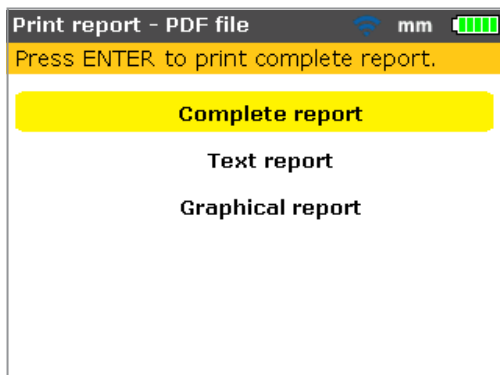

As may be seen from the screen header, the selected printer type is the default – 'PDF file'. In this case, the report will be saved as a PDF on the approved memory stick.

The Product provides the option of printing reports in the following three formats:

- Complete report – this option prints a complete report that includes machine graphics and measurement results in both numerical and graphical format.
- Text report – this option generates reports in text format only.
- Graphical report – reports printed using this option display only graphical representation.

Use  /  to highlight the desired format.

The report format selected in the previous example is a complete report. This includes both graphics and text.

*Note*

*Before confirming the save action, ensure the 'short' USB cable is connected to the Product's grey port, and the approved memory stick (aka jumpdrive or pen drive) attached to the 'short' cable.*

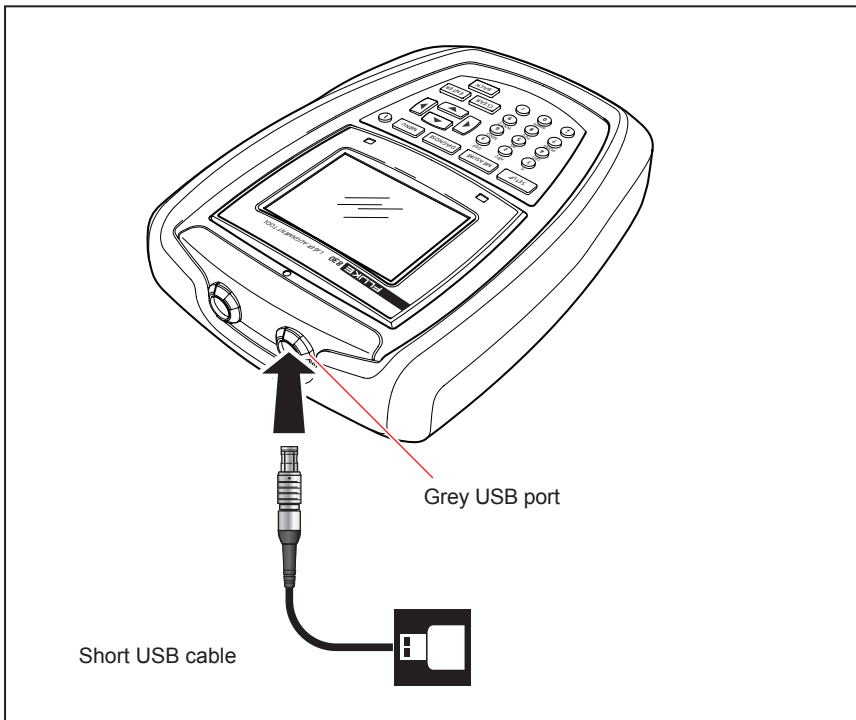
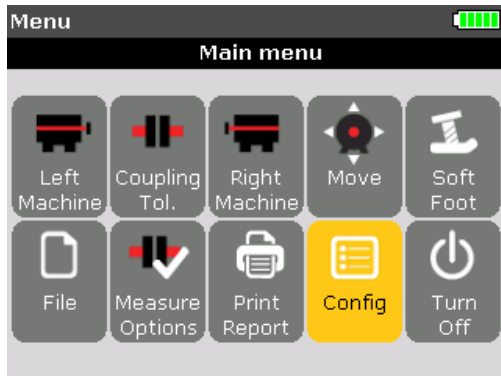

**Figure 7-11. Saving measurement report as PDF on a memory stick**

Press  to print a report of the selected measurement file.

## Configuring printer

If it is desired to print the report directly from the Product, the printer settings must be set accordingly. This can be carried out from the menu. Press **MENU** and use the navigation keys and highlight the 'Config' icon.



Press **ENTER** to confirm selection. The "Configuration menu" screen appears. Use the navigation keys and highlight the 'Printer configuration' icon.

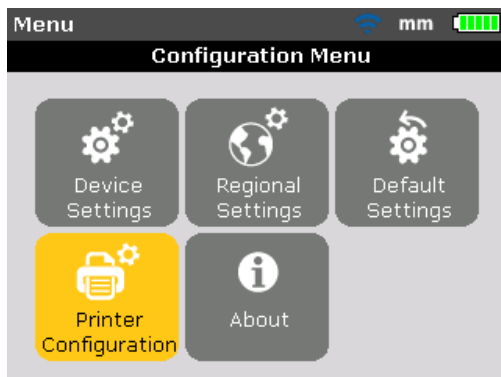



With the 'Printer configuration' icon highlighted, press **ENTER** to reveal the printing options that may be configured.



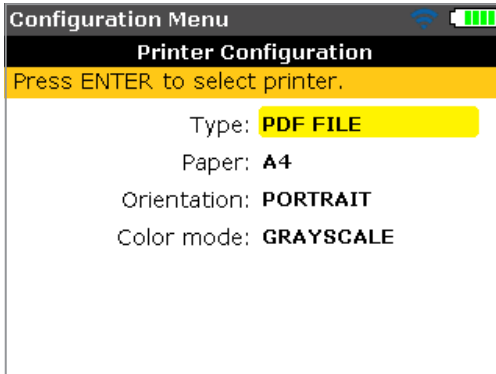

## Available printing options

The “Printer configuration” screen shows the options that can be selected.

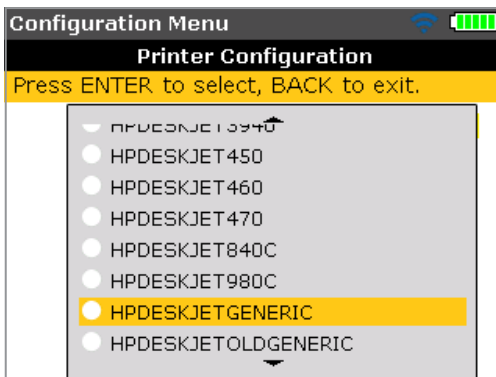

Use either  /  to highlight the printer setting to be changed. In the preceding example, the printer setting selected is printer type, and the currently set printer type is the default – ‘PDF file’. The available printer types are displayed by pressing .



Use  /  to scroll through the available printers. The topmost printer type (in this case the default printer type – ‘PDF file’ – may be selected by pressing ). Highlight a printer and then press  to confirm selection. The measurement report may now be printed directly to the desired printer (in this case ‘HP DeskjetGeneric’). Refer to ‘Printing reports’ previously.

*Note*

Ensure the Product is connected to the printer via the short USB cable and the printer USB cable (supplied with the printer or readily available in most electronics stores) and the printer configuration completed.

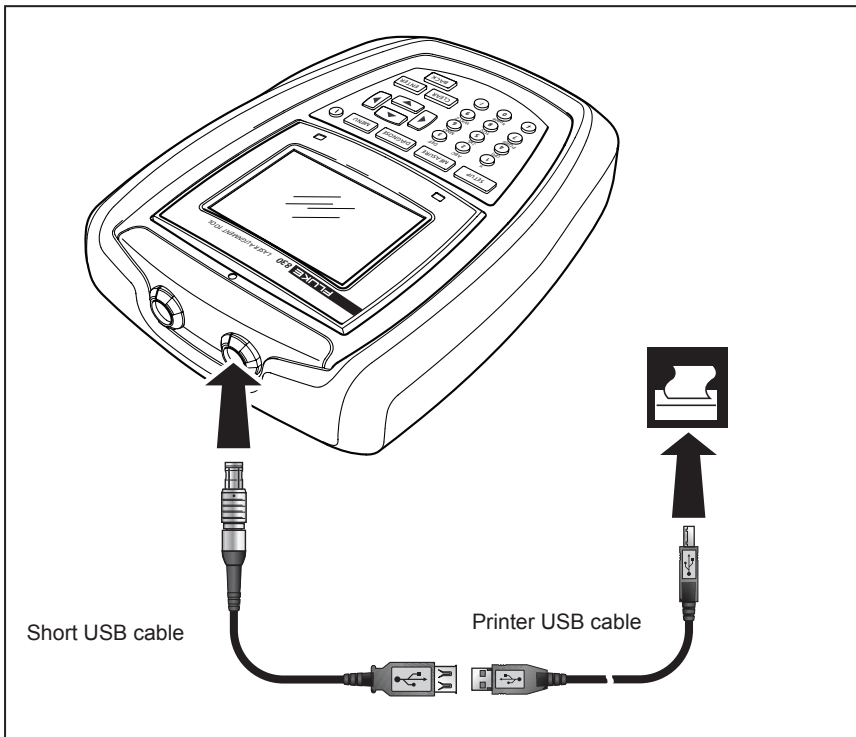
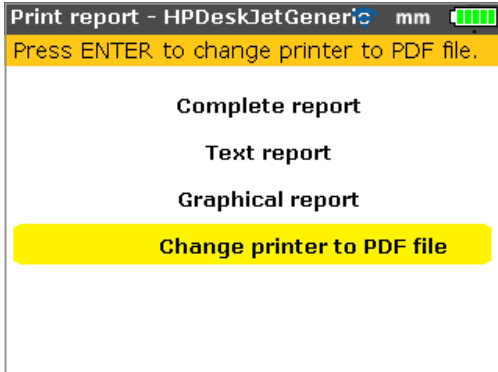



**Figure 7-12. Printing measurement report from Product directly to desired printer**





*Note*

When printing a report directly to a printer, the “Print report” screen provides an option to change to the default printer ‘PDF file’.

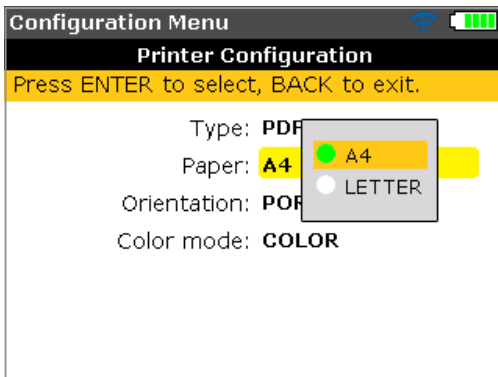

The printer setting ‘Paper’ is used to select paper size. With ‘Paper’ highlighted, press **ENTER** then use  /  to scroll through the available paper sizes. Highlight the required paper size and then press **ENTER** to confirm selection.



The printer setting ‘Orientation’ is used to change the page orientation. With ‘Orientation’ highlighted, press **ENTER** then use  /  to change the page orientation between ‘Portrait’ for a vertical layout and ‘Landscape’ for a horizontal layout. Confirm selection by pressing **ENTER**.

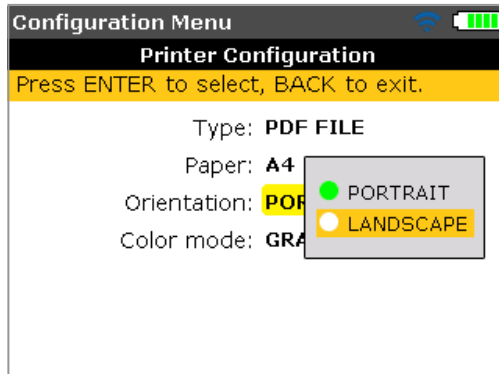

With the setting 'Color mode' highlighted, press **ENTER** then use / to select the color in which the report will be printed. Selecting 'Color' results in full color reports, while 'Gray scale' results in black and white reports.

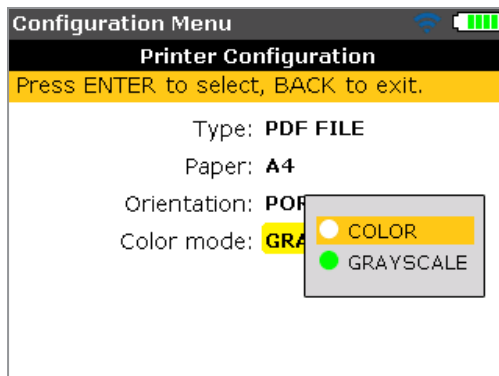

#### Note

Note that with the three printer settings 'Paper', 'Orientation' and 'Color mode', it is possible to toggle between the two available options using / . For example if the setting 'Paper' is highlighted pressing / toggles between the options 'A4' and 'Letter'.

## Soft foot

Soft foot is the condition of machine frame distortion. Any cause that results in machine frame distortion when the machine is anchored to its foundation is a soft foot. Some of the principal causes are:

- Non-coplanar machine mounting surfaces
- Deformed machine frame or feet
- External forces e.g. from connecting pipe or bracketry
- Improper shimming or soiled machine feet
- Too many shims under a machine foot (a maximum of 5 shims should not be exceeded)

The consequences of forcibly tightening down the feet are deformed machine frames, bent shafts and distorted bearings. This leads to high vibration and premature machinery failure.

Soft foot should be checked before aligning the shafts. This can be done quickly and conveniently with the aid of the Product's soft foot function. With the sensor and prism mounted on the shaft in the usual way, the system is able to sense any machine movement when individual machine bolts are loosened. By entering the machine dimensions, the Product is able to calculate, from shaft movement, by how much each foot has moved as it is loosened.

Once foot movements have been established, the results are interpreted and translated into shim thicknesses to be placed under the feet. How straightforward this is, depends on the type of soft foot present.

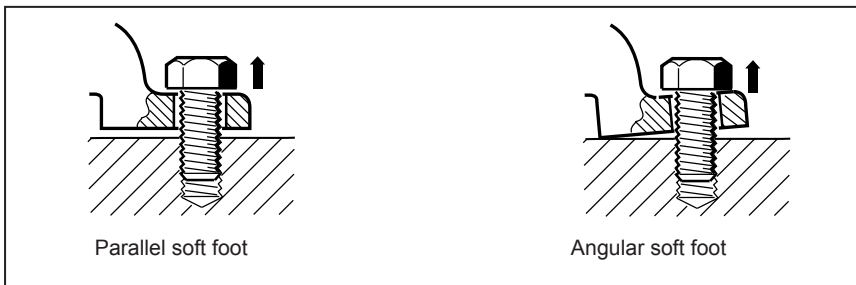

**Figure 7-13. Parallel and angular soft foot**

## Main types of soft foot

The three main types of soft foot are parallel soft foot, angular soft foot, and induced soft foot.

### Parallel soft foot

One or more feet do not reach the foundation. This usually results in the machine leaving a gap between the foundation and the feet. This is corrected by shimming the feet not touching the foundation (refer to Figure 7-13).

### Angular soft foot

The base of the foot is at an angle to its foundation and they are only partly in contact. In this case, suspect foot is checked with a feeler gauge and corrected by building a custom 'shim wedge' or machining the underside of the foot (refer to Figure 7-13).

### Induced soft foot

This type of soft foot is caused by forces that are external to the machine. It can be the result of pipe strain, machine vibrations or drastic misalignment. This type of soft foot may be eliminated by isolating the external force from the machine.

## Checking and correcting soft foot conditions

There are instances where the soft foot is a combination of two or more types. Checking for soft foot is part of machine and job preparation.

### Note

*The machine(s) to be checked is/are assumed to have four feet in an approximately square formation. If the machine has six feet, it is advisable to leave the middle feet loose and treat the machine as a four-footed machine. Soft foot is measured only on machine designated as movable.*

Set up the product in the normal way as described in "Getting started" (starting on page 39).

Rotate shafts to position the sensor and prism at either the 3:00 or 9:00 o'clock position.

Enter machine dimensions then press . Use the navigation keys and highlight the 'Soft foot' icon.

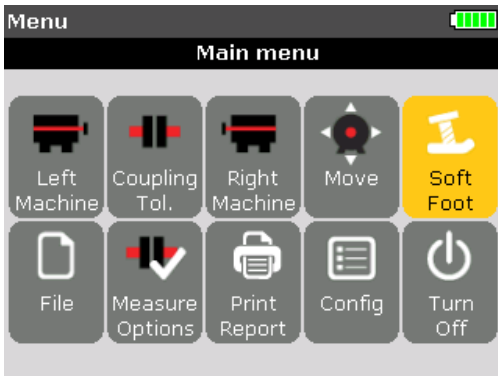

Press **ENTER** to confirm selection.

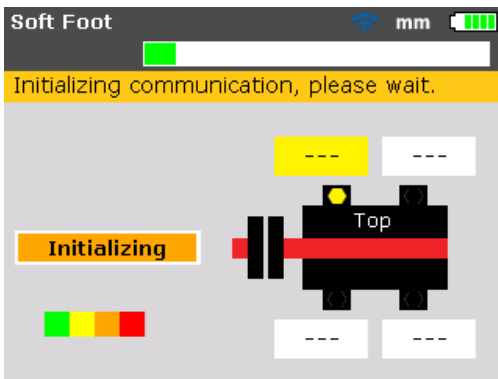

Once sensor initialization is completed and provided the laser beam was correctly centered ( see 'Laser beam adjustment' in chapter 7) the 'Laser READY' hint appears on the Product's display.

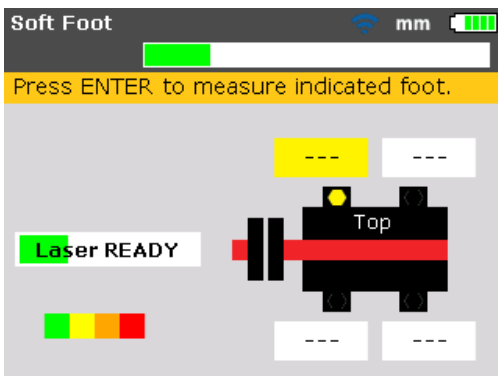

Use the navigation keys to select the foot to be measured. Press **ENTER** to confirm foot selection.

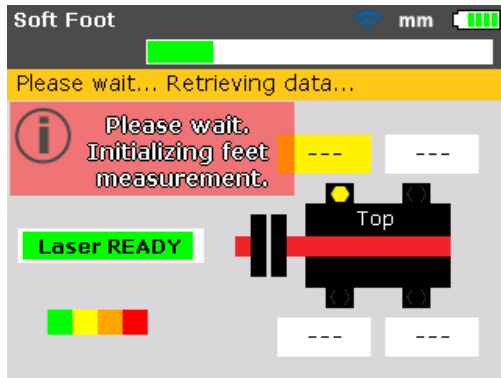

Note the hint on the screen carefully. After selection of the foot to be measured, pressing **ENTER** activates the process of identifying foot to be measured. After foot to be measured has been identified, the value +0.00 appears in its value box plus a hint indicating that the foot anchor bolt may be loosened.

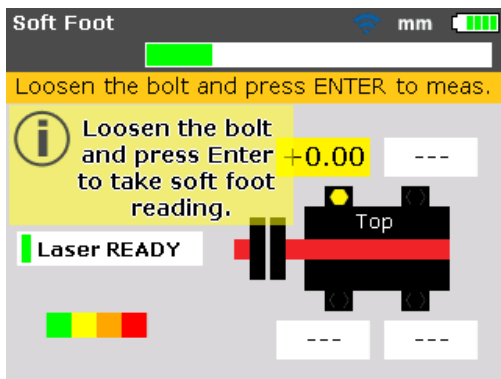

Loosen the corresponding anchor bolt then press **ENTER**.



The calculated amount that the foot has moved is shown on the screen. Retighten the bolt. The next foot is highlighted automatically, or any desired foot can be selected using the navigation keys.

Repeat this procedure for each foot. Cycle through using the navigation keys.

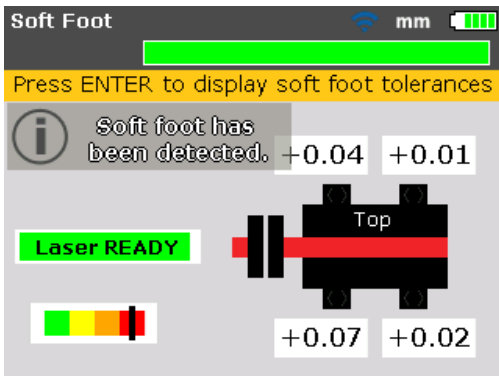

The marker on the color-coded tolerance bar shows the tolerance value of the measured soft foot.

As the set soft foot tolerance is 0.06 mm (0.002"), the marker on the color-coded tolerance indicates that the measured soft foot is out of tolerance and shimming corrections are necessary.

With the four foot values, the soft foot condition can be analyzed and diagnosed, then the shimming corrections can be determined. Note that these values are saved in the file along with the dimensions, measurement and diagnosis, and appear in the printed report.

## Points to be observed during soft foot measurement

### Laser beam not centered

If initially the laser beam has not been centered, the following screen appears.

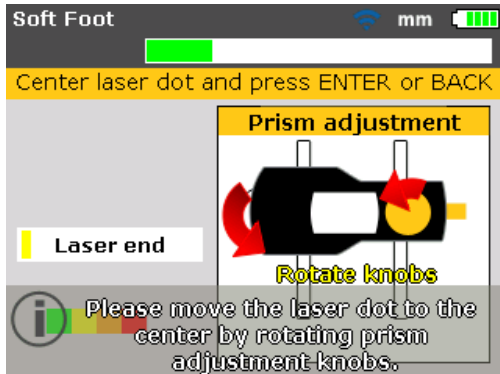

Use the on-screen instructions to adjust the laser beam. You may refer to 'Laser beam adjustment' on page 60.

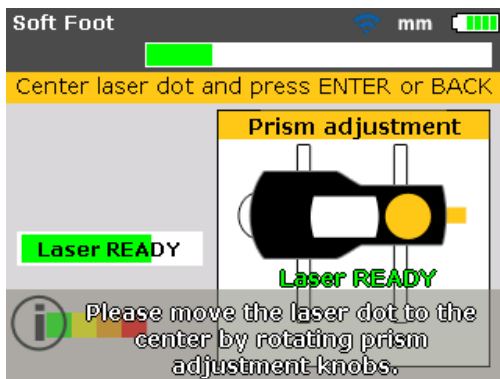

After centering the laser beam, press either **BACK** or **ENTER** and proceed with soft foot measurement.





## Dimension missing

### Note

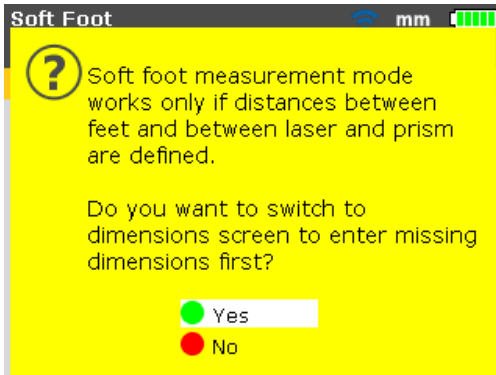
If however, either of the two significant machine dimensions, “front foot-to-back foot” and “sensor-to-prism”, are missing, the following hint appears.



Use / and highlight 'Yes', confirming selection by pressing . The dimensions screen opens, and missing values may be entered.

## Shafts have rotated accidentally or not positioned at either 3:00 or 9:00 o'clock position

If the shafts rotate away from the 3:00 or 9:00 o'clock position, an angle correction hint appears as shown below.

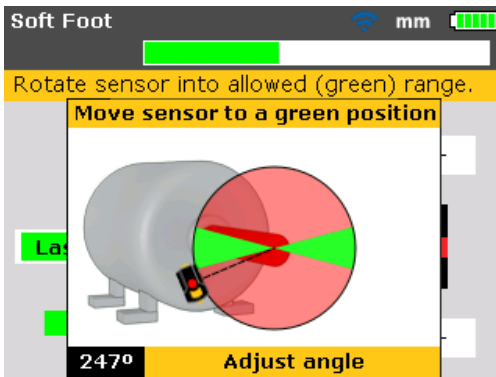

Rotate the shafts back into the green sector to resume measurement.

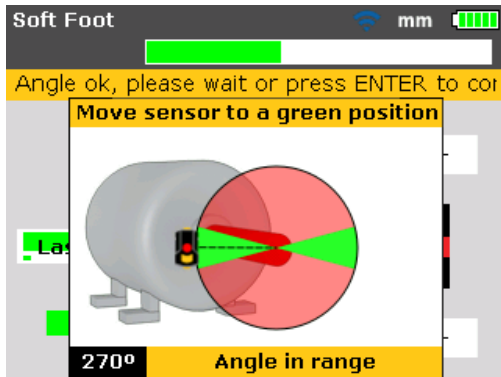

When the message “angle in range” appears, you may press **ENTER** / **BACK** to continue with soft foot measurement. Alternatively, you may wait for the process to resume automatically.

#### Note

*If the soft foot procedure is followed correctly, the above mentioned points will not arise.*

### Parallel soft foot correction

In parallel soft foot, the machine rocks on two diagonal feet which are lower than the other two. If two diagonal values are roughly equal and significantly higher than the other two, parallel soft foot can be assumed as a first solution.

In Figure 7-14, the correction would be to place a 0.89 mm shim under foot ‘b’ (the foot with the largest gap).

### Angular soft foot correction

In angular soft foot, the base of one or more feet is at an angle to the foundation and is only partly in contact. If one value is significantly higher than the others, then angular soft foot can be suspected.

The ‘problem foot’ or machine frame is probably bent or distorted in some way. In this case loosen the bolt and examine the foot more closely. Use a feeler gauge to establish the variation of the gap and use these measurements to sketch the shape and dimensions for a ‘stair stepped shim wedge’.

If the soft foot is purely ‘angular’ then the stepped shim will vary in thickness from zero to twice the value displayed by the Product.

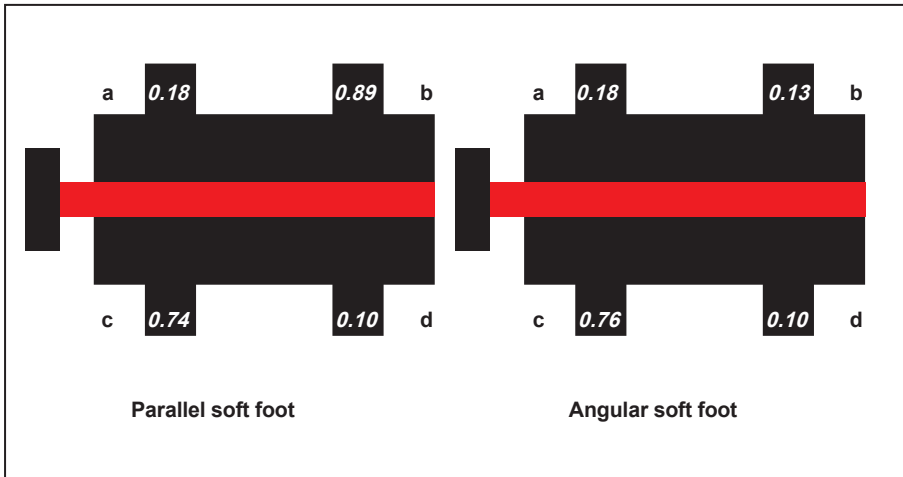

Figure 7-14. Diagnosis of parallel and angular soft foot

Page intentionally left blank

## 8. Alignment options

### Measurement modes

The Product's default measurement modes are **Compass mode** (for horizontal mounted machines) and **Clock mode** (for vertical mounted machines).

Both measurement modes may be accessed via the menu.

*Note*

*The respective default mode is automatically present when the “Measure” screen is accessed after entering all necessary machine dimensions.*

Press **MENU** to access the 'Main menu' screen. While in the menu screen, use the navigation keys and highlight the 'Measure options' icon.

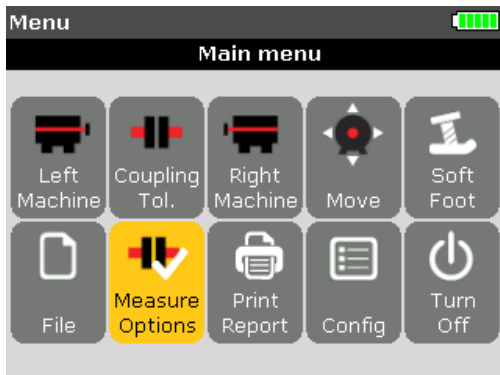

Press **ENTER** to confirm selection and enter the “Measurement options” screen.

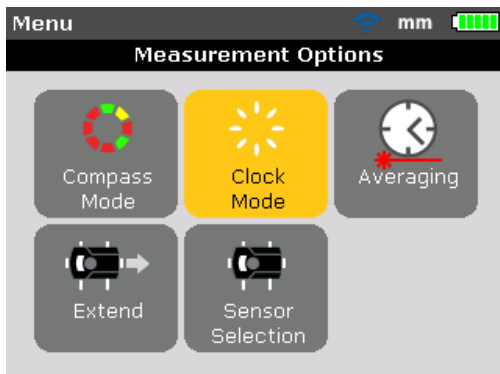

*Note*

*The “Measurement options” screen is accessible only when all necessary machine dimensions, in the currently opened measurement file, have been entered.*

Using the navigation keys, highlight the required measurement mode, and then press **ENTER** to confirm selection.

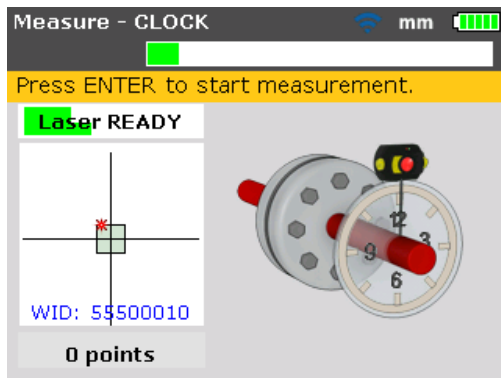

In the above case, the selected measurement mode is the ‘Clock’ mode which is the default measurement mode for vertical mounted machines (described in chapter 9 ‘Vertical flanged machines’).

### **Extending the measurement range**

Gross misalignment of shafts or angular misalignment over large distances can cause the laser beam to miss the detector surface during measurement. When this happens, ‘Laser End’ appears on the display screen and the Product’s ‘extend’ function can be used.

1. When measuring and ‘Laser End’ message appears, rotate the shafts backwards until the laser beam re-enters the measurement range. The message ‘Laser READY’ reappears on the display.

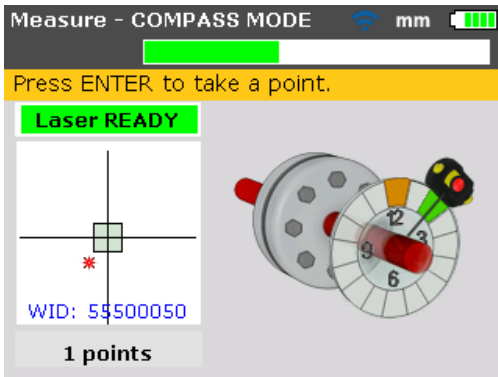

2. Press **MENU** to access the “Main menu” screen. While in the menu screen use the navigation keys and highlight the ‘Measure options’ icon and then confirm selection by pressing **ENTER**. The “Measurement options” screen opens.

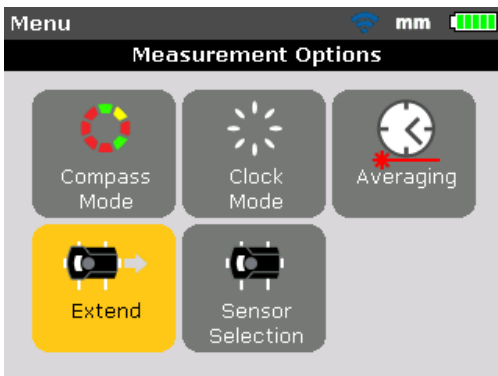

3. Use the navigation keys to highlight the ‘Extend’ icon, then press **ENTER** to confirm selection. The program interrupts measurement and switches to the beam adjustment screen. The current beam position is automatically recorded and taken as the starting point for range extension.

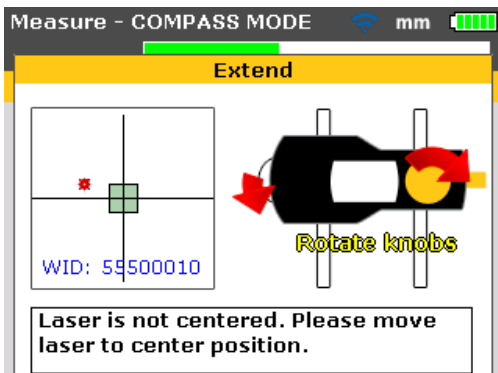

- Readjust the beam into the target square using the yellow prism knob and the metal thumbwheel.

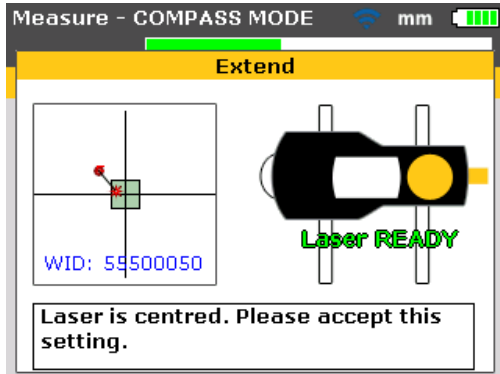

- On centering the laser dot, the Product's right LED turns blue. The adjusted beam position is automatically recorded and taken as the end point of the readjustment.
- Continue measurement as before, rotating the shafts and pressing **ENTER** to take measurements at the available positions.



The program includes the displacement of beam readjustment in its alignment calculations.

#### Note

*'Laser End' is displayed when the reflected beam fails to strike the detector. This situation occurs when machines are severely misaligned, or when the beam travel is long. Measurement is not taken when this message appears.*

### Averaging

In certain industrial conditions, it may be necessary to increase the number of measurements to be averaged when taking readings to attain the desired accuracy. Particular cases include applications with increased machinery vibration. An increased averaging also improves the accuracy when measuring sleeve bearings, white metal bearings and journal bearings.

The number of individual readings which are averaged together to form one measurement are set via the "Measurement options" screen. Press **MENU** to access the menu. While in the menu screen use the navigation keys to highlight the 'Measure options' icon and confirm selection by pressing **ENTER**. The "Measurement options" screen opens.



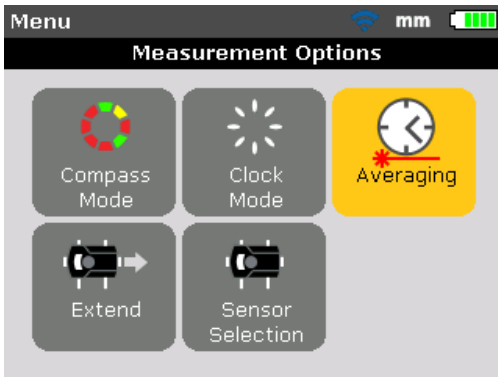

Use the navigation keys to highlight the 'Averaging' icon, then press **ENTER** to confirm selection.

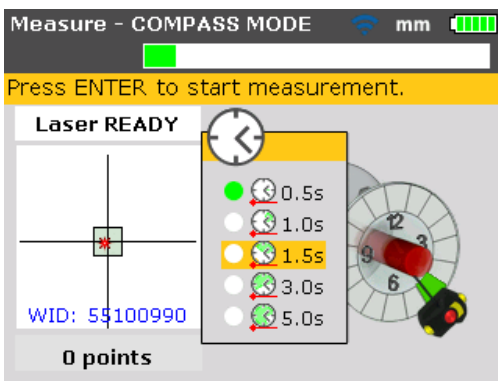

The average setting can be changed from a minimum averaging of 0.5 seconds to a maximum averaging of 5.0 seconds.

*Note*

*The averaging setting that is selected will also be active in soft foot and Move. Should high averaging be selected, patience must be exercised during Move to allow the Product enough time to “catch-up” as the machine is moved. In this case, each reading that must be calculated to update the graphic display will take a longer time. Averaging cannot be changed once a measurement has been started.*

Page intentionally left blank

## 9. Vertical flanged machines

### Typical configuration

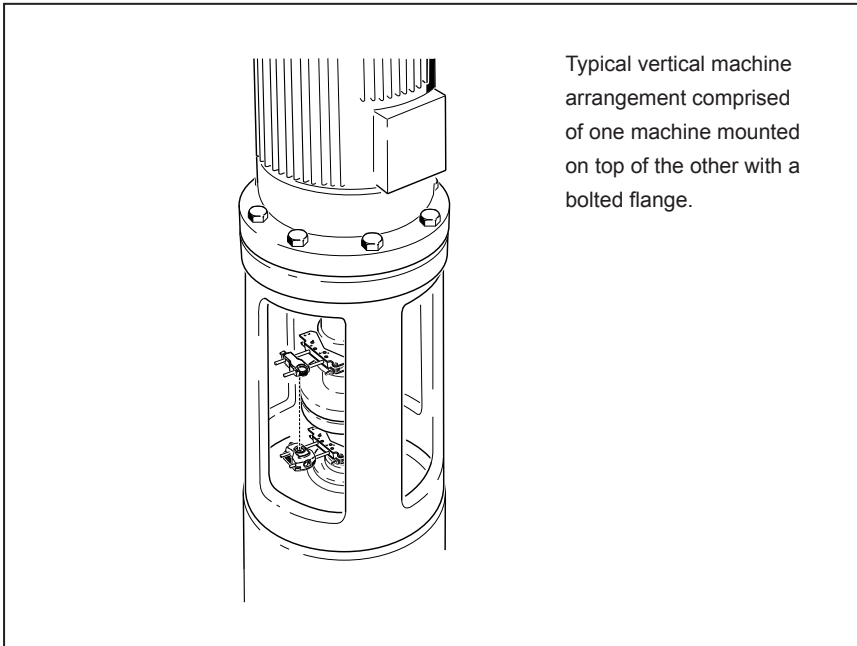

**Figure 9-1. Typical vertical machine configuration**

Figure 9-1 shows a typical vertical machine arrangement with one machine mounted on top of the other using a bolted flange.

In flange-mounted machines, alignment corrections are made directly at the flange.

Angularity is corrected by inserting or removing shims between the flanges.

The Product calculates the shimming thickness for each flange bolt. Offset is corrected by positioning the flange laterally.

## Set-up

### Note

Before commencing with this section, please acquaint yourself with the chapter 'Horizontal machine alignment' starting on page 47.

The sensor and prism are mounted on either side of the coupling as for horizontal machines, with the sensor on the bottom half ('Stationary') and the prism on the upper half ('Movable'). In this set-up, the electronic inclinometer cannot detect the rotation angle of vertical shafts. Measurement of vertical machines is carried out using 'Clock' measurement mode. The eight 45° measurement positions used with this procedure must be marked accordingly on the machine.

### Marking measurement positions

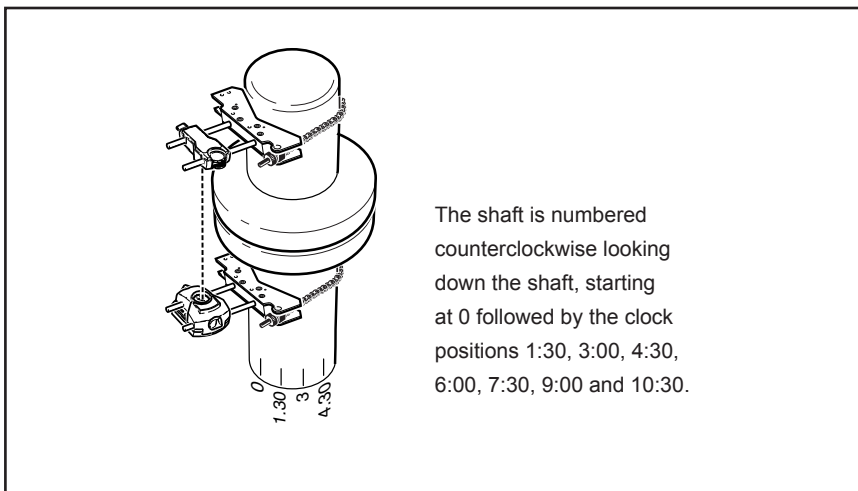

**Figure 9-2. Numbering the shaft**

1. Mark a reference position on the coupling housing close to the shaft and in line with one of the pillars or bolts. Likewise, mark a starting point on the shaft. This ensures that lateral corrections can be performed with the minimum of effort.
2. Measure the circumference of the shaft and divide by eight.
3. Use this distance to make seven more evenly-spaced marks on the shaft beginning at your chosen start point. Number the points counterclockwise as seen from prism to sensor, beginning with 0 first, followed by 1:30, 3:00, 4:30, 6:00, 7:30, 9:00 and 10:30. (Refer to Figure 9-2.)

For circular housings, measure the circumference of the coupling housing and divide by eight. Use this distance to make eight evenly-spaced marks on the housing beginning at your chosen start point. Number the points clockwise looking down onto the shaft with 0 as the first, followed by 1:30, 3:00, 4:30, 6:00, 7:30, 9:00 and 10:30. (Refer to figure 9-3.)

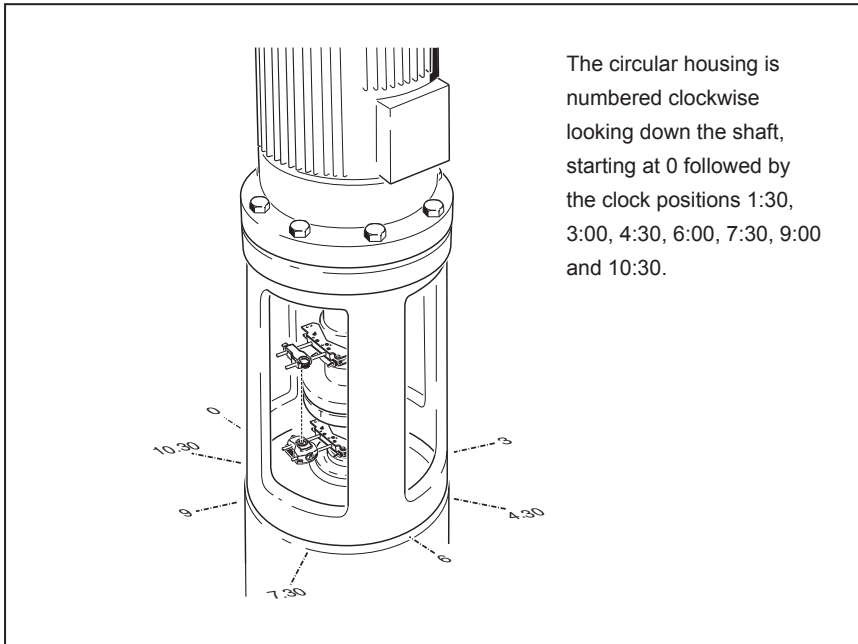

**Figure 9-3. Numbering the housing**

### **Mounting components and determining machine orientation**

1. Mount the wireless module together with the sensor on one side of the coupling, and prism on the opposite side of the coupling, ensuring that they are aligned exactly with the 0 or reference mark.
2. Switch the Product on.
3. When the “Setup” screen appears, press **MENU** to access the “Main menu” screen. Use the navigation keys and highlight the ‘Right machine’ icon.

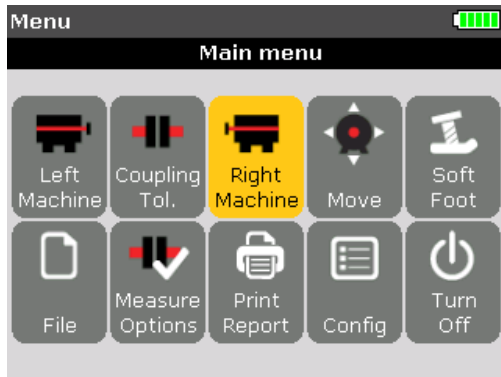

4. Press **ENTER** to confirm selection then use the navigation keys and highlight the 'Change to flange' icon.

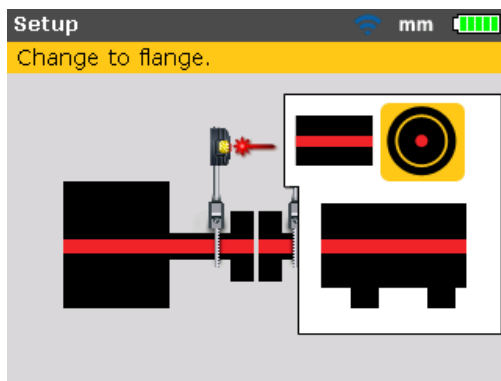

5. Press **ENTER** to confirm selection. The "Edit flange" screen appears. This indicates a vertical machine orientation.

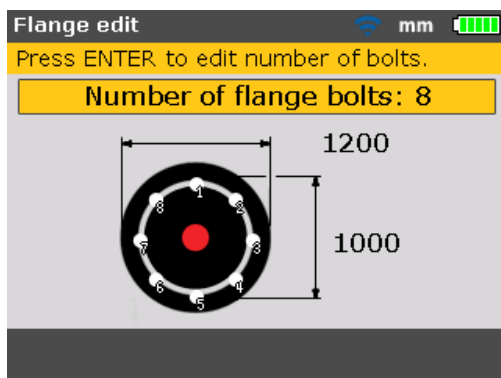

### Editing flange configuration

A typical vertical machine train arrangement consists of machines mounted together using a bolted flange. To configure the flange proceed as follows:

1. Once in the “Edit flange” screen use the navigation keys to cycle through the flange pattern parameters that may be edited. These include:
  - Shape and dimensions of flange
  - Bolt pattern and number of flange bolts
2. Use the navigation keys to cycle through the elements in the “Edit flange” screen.

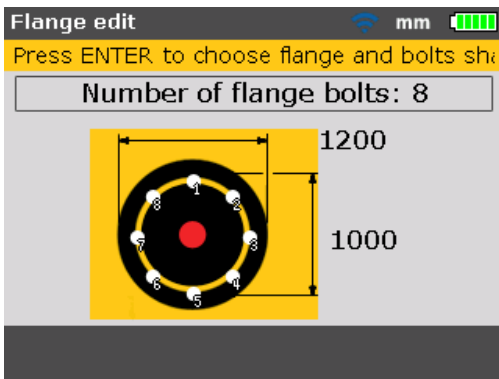

3. With the flange highlighted, press **ENTER**.

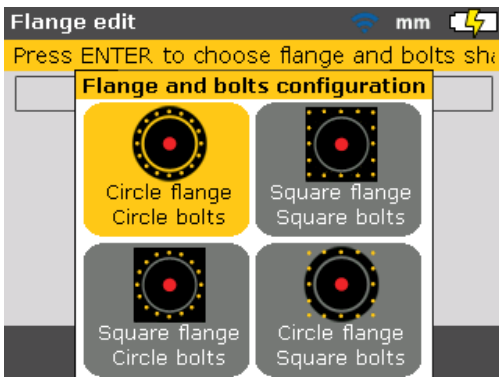

The following flange patterns are available:

- Circular flange – circular bolt pattern
- Square/Rectangle flange – square/rectangular bolt pattern
- Square/Rectangle flange – circular bolt pattern
- Circular flange – square/rectangular bolt pattern

4. Use the navigation keys to highlight the desired flange configuration, pressing **ENTER** to confirm selection.
5. To edit the dimensions of the selected flange pattern, use the navigation keys to highlight dimension to be edited, then enter value directly using the data entry keys.

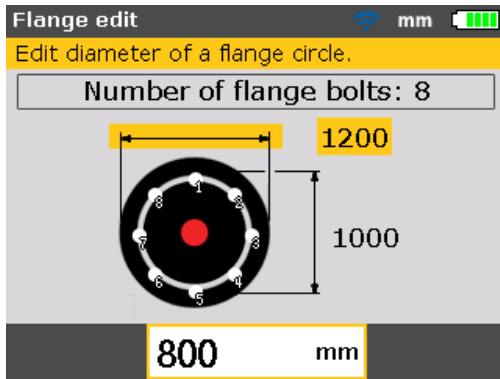

Press **ENTER** or **BACK** to confirm entry.

6. Bolt pattern dimensions are edited in the same manner as the flange pattern dimension. Use the navigation keys to highlight the dimension to be edited, then enter value directly using the data entry keys.

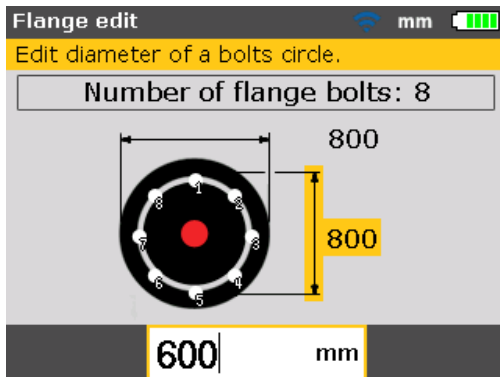

Press **ENTER** or **BACK** to confirm entry.



- To edit the number of flange bolts, use the navigation keys to highlight 'Number of flange bolts:'

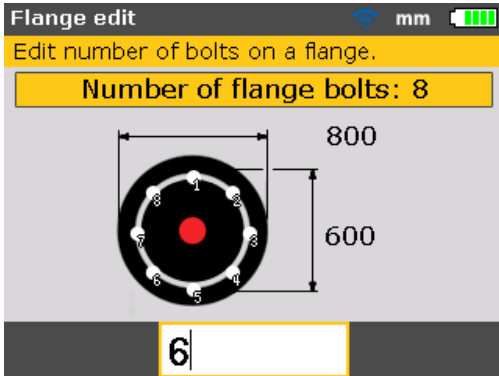

With the button 'Number of flange bolts:' highlighted, edit value directly using the data entry keys then confirm value by pressing either **ENTER** or **BACK**.

### Enter dimensions

Press **BACK** or **SETUP** to return to the dimensions screen.

- Enter the sensor-to-prism distance.

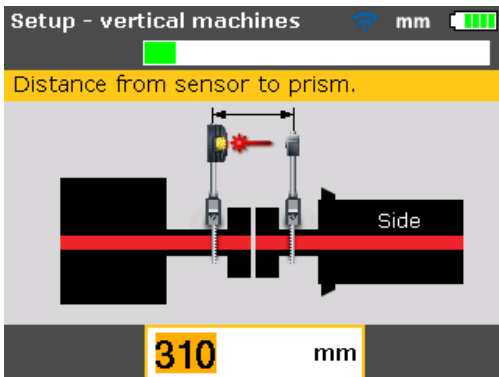

#### Note

The sensor-to-coupling center distance is calculated as half the sensor-to-prism distance automatically. Should need be, this value can be edited directly using the data entry keys.

2. Enter the coupling diameter. The default is 100 mm (10" if units option is set to imperial units.)

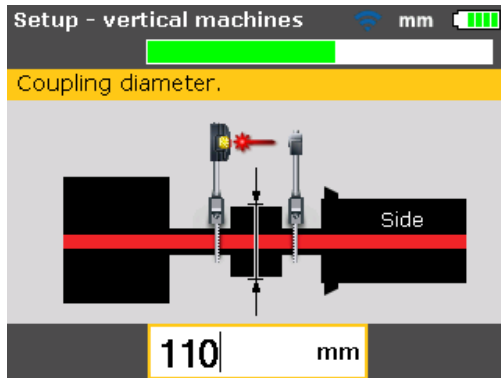

3. Enter the RPM. The default is 1500. (1800 if units option is set to US customary units.)

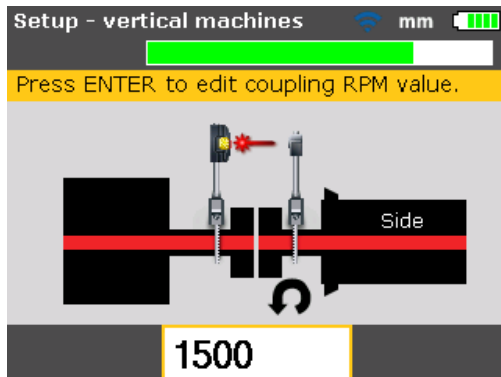

4. Enter the coupling center-to-flange distance.

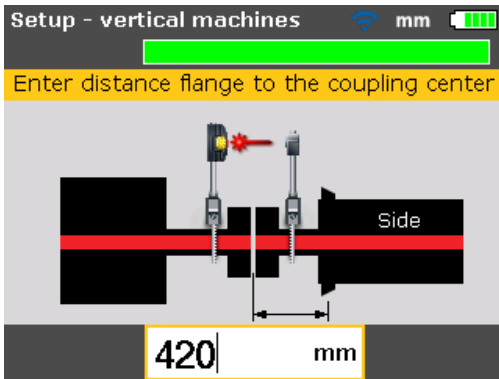





Measurements can now be made.

### Measure

1. Switch the wireless module on to power the sensor. Press **MEASURE** then proceed to adjust the laser beam and establish wireless communication as described in the respective sections in Chapter 7 'Horizontal machine alignment'.
2. Once the laser beam has been centered and wireless communication established, the "Measure" screen shows the laser centered and the 'Clock' measurement mode activated.
3. Rotate the shafts to the first measurement position. The reference mark and the measurement position 0 must be aligned with each other. Use the navigation keys to place the screen hour hand to correspond with the position of the prism and sensor on the shafts.

#### Note

Pressing  /  positions the clock hour hand at the next 45° position in a clockwise direction. Pressing  /  positions the clock hour hand at the next 45° position in an anticlockwise direction.

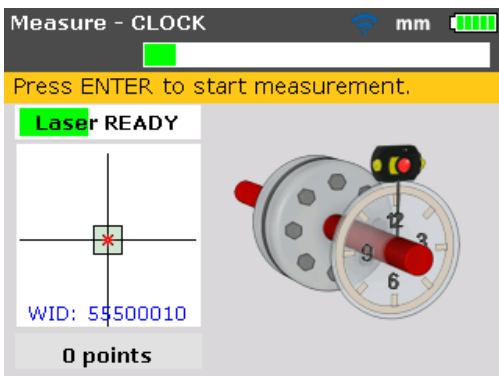

4. Press **ENTER** to take the first measurement point.

*Note*

*After taking measurement point, the clock hour hand moves automatically to the next clock position. (If the first measured position is 12:00 o'clock, then the hour hand moves to the 1.30 o'clock position).*

5. Rotate the shafts to the next measurement position (this could be either 1:30, 3.00, 4.30, 6.00, 7.30, 9.00 or 10.30 o'clock position).

*Note*

*If shaft rotation restrictions hinder the taking of measurement at particular shaft positions, bypass these using the navigation keys.*

6. Press **ENTER** to take measurement point.

*Note*

*A minimum of three measurement positions are required to obtain results, but it is recommended that a maximum number of measurement points over a wider rotational angle be taken to enhance the diagnosis.*

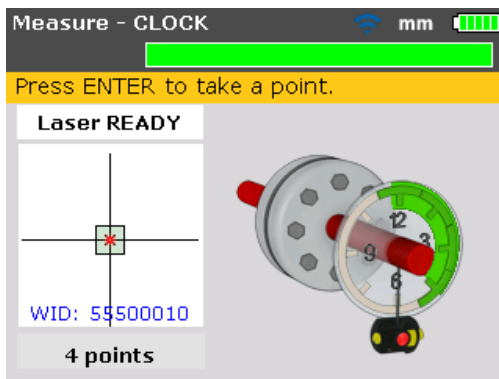

## Diagnose

When measurement is complete, press **DIAGNOSE** to view the diagnosis.

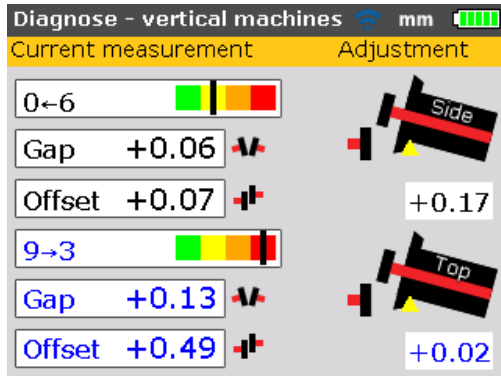

Note

**Sign convention** (for vertical machines)

POSITIVE GAP opens towards 0:00 or 3:00

POSITIVE OFFSET if the top coupling half is offset towards 0:00 or 3:00

Cycle through the coupling results and the flange corrections by pressing **DIAGNOSE** repeatedly.

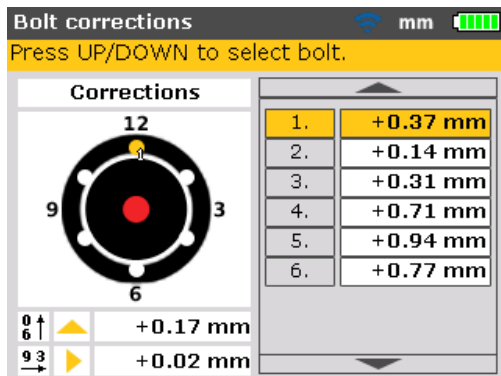

The shim corrections are numbered to correspond with the bolt positions. The bolt position corresponding to the currently highlighted calculated shim correction value appears numbered and highlighted with an orange dot.

Use the navigation keys to cycle through the shim values.

Pressing the navigation keys long enough or  changes the bolt correction value mode. The following options are available:

- Bolt correction (+): means all shimming corrections are positive (add shims)
- Bolt correction (-): means all shimming corrections are negative (remove shims)
- Bolt correction ( $\pm$ ): means all shimming corrections are minimized (optimized). Therefore half of the corrections will be negative and half of them positive. This option results in zero axial movement of the shaft.

## Machine alignment

Alignment is carried out by correcting angularity and offset at the flange.

### Correcting angularity

1. Loosen the flange bolts and lift the upper machine.



**Caution**

**The machine bolts must be undamaged and removable.**

2. Angularity corrections are made by shimming. The “Bolt corrections” screen shows the shimming values at the respective bolt locations. Insert (or remove) shims with the correct thickness under the selected bolt.
3. Retighten the bolts and then re-measure to verify flange shimming results and determine the exact alignment condition.

### Correcting offset

The correction of offset misalignment is carried out using the Live Move function.

1. Access the “Main menu” screen by pressing . Use the navigation keys and highlight the ‘Move’ icon.

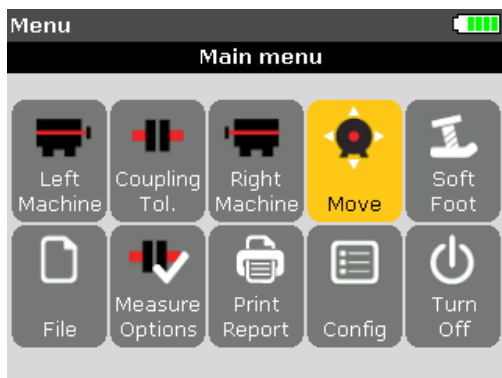



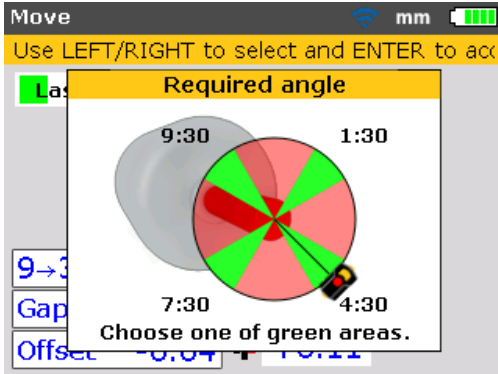

2. Confirm selection by pressing **ENTER**.
3. On confirmation the screen used to position the sensor and prism for optimal moves appears.



4. Rotate shaft to any of the four positions highlighted in green. These are 1:30, 4:30, 7:30 and 10:30.
5. Use the navigation keys to position the sensor on the screen to correspond to the position of the sensor and prism on the shafts.
6. Press **ENTER** to start Live Move. The Move direction dialog window appears.



7. Use either  or  to highlight the required direction of movement. This could be either  or . Confirm selection by pressing **ENTER**.

*Note*

*If the laser beam is centered, Live Move starts automatically. If beam is not centered, a hint to center the laser beam appears on the display.*

8. Loosen the flange bolts. Move the machine laterally in the direction of the yellow triangle as indicated in the Live Move display.

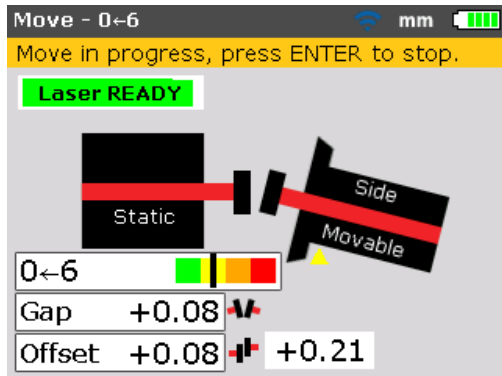

9. Corrections should be brought as close as possible to zero. The marking on the color-coded tolerance bar should change from red to orange to yellow and finally green. At the same time the alignment condition LED also changes color dependent on the position of the marking on the tolerance bar.

#### Note

*Use appropriate tools, such as levers, to position the machine.  
Take care not to let the shims slip out of place during lateral positioning.  
When machine is correctly positioned, tighten the bolts back down. Re-measure to check if the new alignment condition is within tolerance.*



## 10. Appendix

### Using the sensor cable

If you need to use the sensor cable (due to flat batteries in the wireless module) then it must be properly attached to the sensor. To attach the sensor cable proceed as follows:

#### Open the front of the sensor housing

Unscrew the left-hand locking knob as shown in Figure 10-1, then lift off the front of the sensor housing. Note how the wireless module cable is held in place by grooves in the sensor frame.

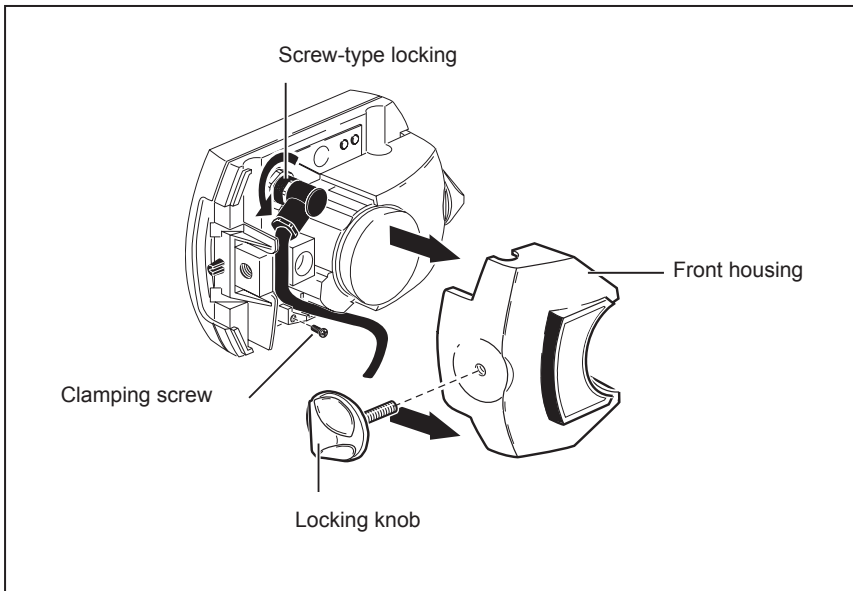

Figure 10-1. Replacing the wireless module cable with the sensor cable

#### Unscrew and remove wireless module cable

Undo the screw-type locking, and carefully lift the wireless module cable out of its guide grooves.

#### Attach sensor cable

Insert the angled plug into the sensor socket as shown in Figure 10-2; note the keyway indicating proper plug orientation. Tighten the screw-type locking to fasten the cable connection.

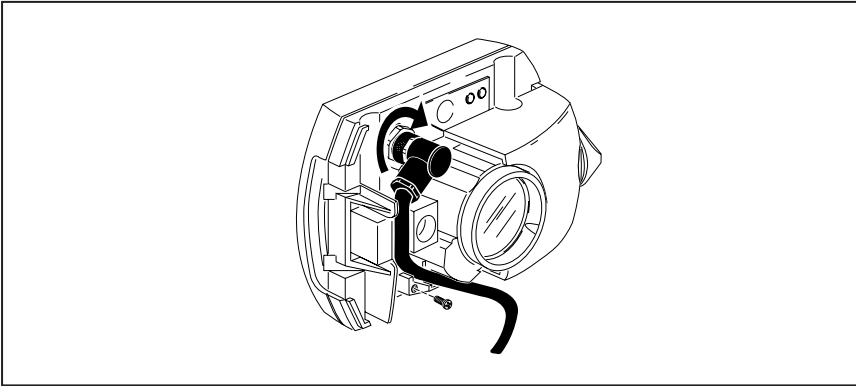

**Figure 10-2. Fastening the sensor cable**



**Never turn the plug itself, as that can damage the cable pins.**

Carefully thread the cable into its guide grooves as shown in Figure 10-2. Ensure the cable remains in place.

### **Close the sensor housing**

Return the front portion of the sensor housing to its position, then retighten the yellow locking knob into place.

### **Test the cable connection**

Insert the straight-ended plug of the sensor cable into the blue sensor port on the Product (see Figure 7-5).



**Match the direction arrows on the plug to the white arrow on the blue port to ensure proper plug orientation; otherwise the pins inside the plug may be damaged.**

Switch the Product on then use the “Measurement options” screen to set the required communication port.

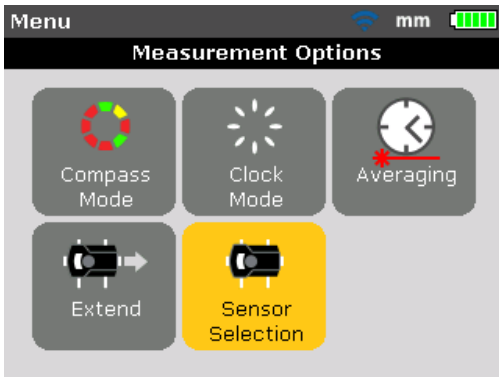

Using the navigation keys, highlight the 'Sensor selection' icon, then press **ENTER** to confirm selection.

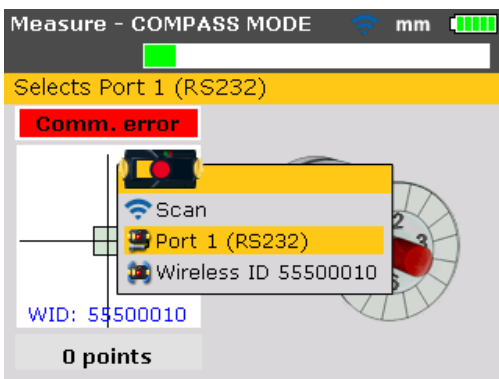

In the selection window that appears, use **↑**/**↓** and highlight the item 'Port 1 (RS232)'. Confirm selection by pressing **ENTER**. The serial port is now initialized. With the sensor dust cap fitted, press **MEASURE** to activate the laser. The red indicator LED of the sensor should blink to indicate beam emission. If not, ensure that the sensor cable has been properly connected; otherwise, contact FLUKE.

*Note*

*Both sensor and wireless module cables may be replaced in the same manner as described in this chapter.*

## Updating the 830 firmware to a newer version

### Note

- The Product firmware updates are carried out with the use of the approved FLUKE USB memory stick.
- Check the website [www.fluke.com](http://www.fluke.com) to ensure you have the latest version. If in doubt, contact FLUKE.
- If you are acquiring the update via the website, you will be required to transfer it to the approved memory stick before commencing the upgrading.

### Note

Old memory sticks must be disposed of in accordance to the directive on Waste Electrical and Electronic Equipment (WEEE).



## Downloading the firmware from the website

The file available for download is an .exe file. Download the file to a directory.

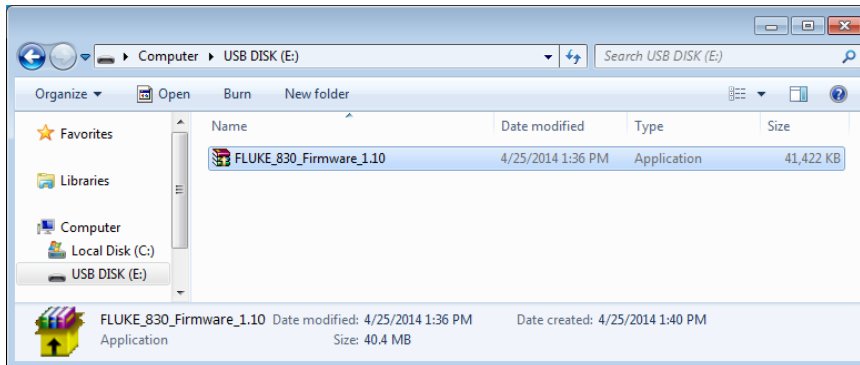

Double-click the file to extract it to the approved memory stick. The following screen with instructions on how to extract the firmware files into the memory stick appears.

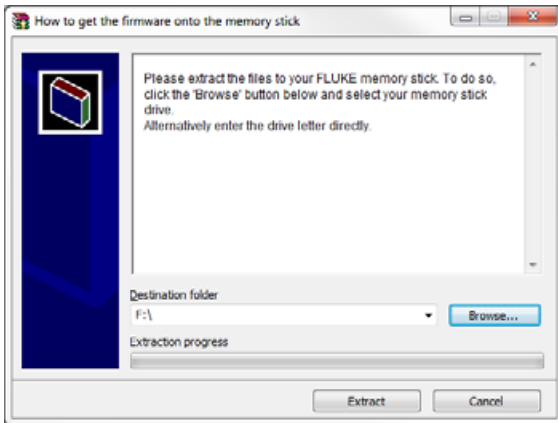

After selecting the location of the approved memory stick by clicking 'Browse', start file extraction by clicking 'Extract'.

### **Carrying out the firmware update**

The firmware update is carried out using the memory stick and the 'short' USB cable. The actual update does not require a PC.

Before starting the update verify that your memory stick has the following files on it.

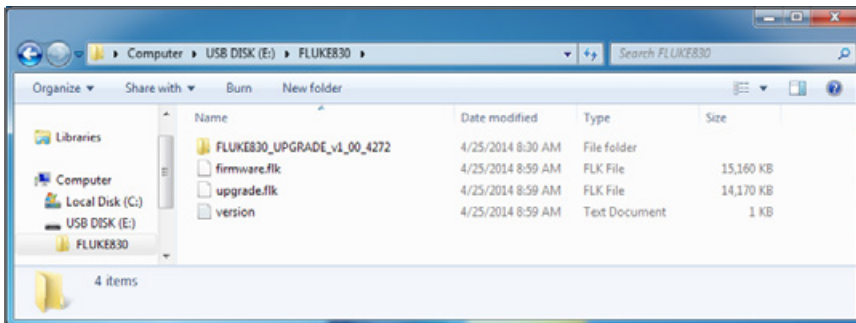

#### **Note**



*The displayed files and folder are viewed by expanding the folder 'FLUKE830'. The downloaded version is indicated by the prefix v1\_xx\_yyyy, where 1\_xx represents the firmware version and yyyy the build number.*

1. Press  to switch the Product on. Wait for the “Setup” screen to appear.

*Note*

*Before proceeding with the update ensure that the indicated nominal capacity of the battery is greater than 50%. If this is not the case, recharge the battery to full capacity first.*

To check battery capacity proceed as follows:

- Press .
- When in the “Main menu” screen use the navigation keys and highlight the ‘Config’ icon. Confirm selection by pressing .
- After accessing the “Configuration menu” screen use the navigation keys and highlight the ‘Device settings’ icon then press  to confirm selection. The actual battery capacity is indicated in the screen that appears.

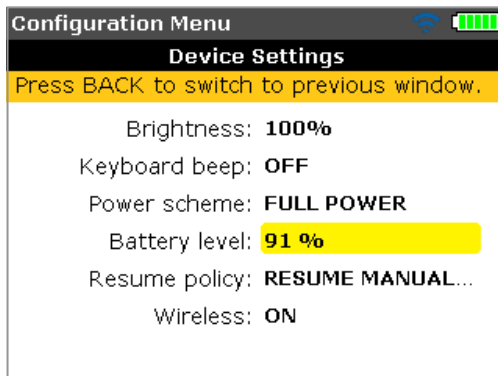

2. Attach the ‘short’ USB cable to the Product’s grey USB port.
3. Insert the approved memory stick into the ‘short’ USB cable.

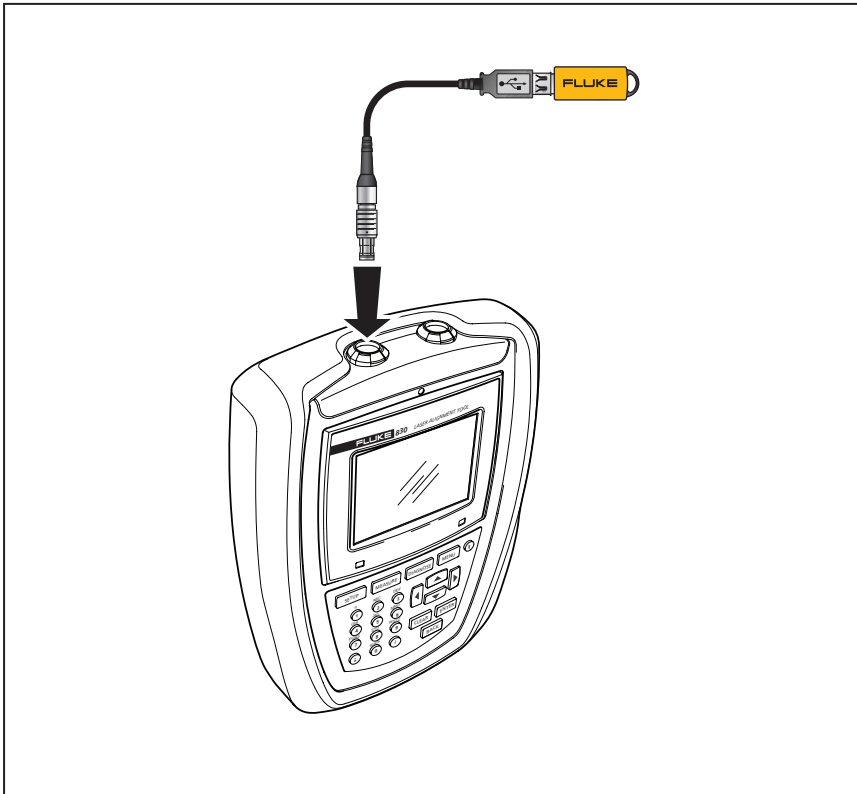

**Figure 10-3. Memory stick connected to the Product using the 'short' USB cable**

4. A hint indicating the availability of a new firmware and the need to reboot the Product appears.



- When the hint above appears, press and hold down  until the device reboots. The display goes dark.
- The update process will start automatically (wait up to 10 seconds). The system beeps and the right LED flashes as the process begins.



*Note*

*Do NOT turn off the device or remove the memory stick during the entire update process, which takes up to 5 minutes.*

- Just before the firmware update process comes to an end, the screen below appears.



- After the flashing process is completed, a hint indicating that the flashing process for the new firmware has been carried out correctly appears.



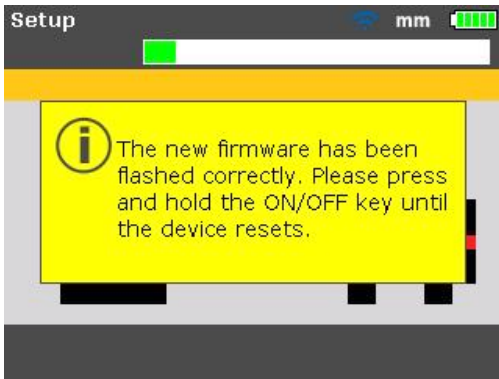



9. When the hint above appears, press and hold down  until the device reboots, and the “Setup” screen appears.

*Note*

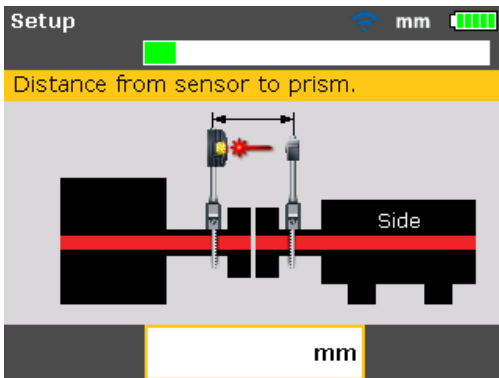
*The ‘short’ USB cable may now be detached from the Product.*



10. When the “Setup” screen appears, press . Use the navigation keys and highlight the ‘Config’ icon. With the icon highlighted, press  to access the “Configuration menu” screen.

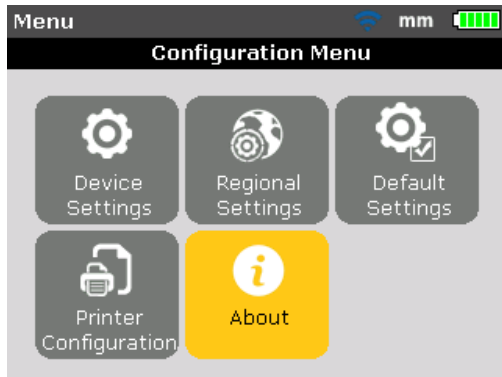

11. Use the navigation keys and highlight the 'About' icon. With the icon highlighted, confirm selection by pressing **ENTER**. The "Application details" window appears.

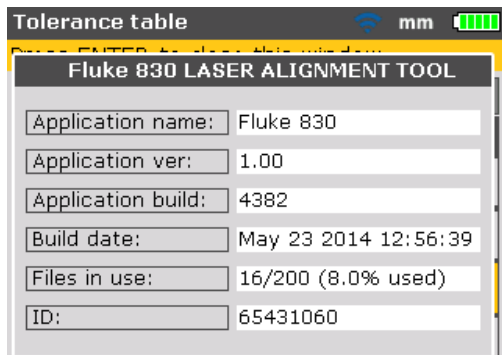



The Product is now ready for use with the uploaded version which may be identified from the "Application details" screen. Also displayed is the current application build.

## Sensor firmware update

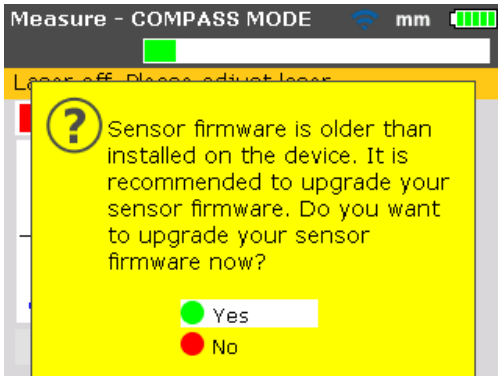

If a sensor with an older firmware version is connected to the Product, a hint indicating that the sensor firmware requires updating appears on the display.



Use   and select 'Yes' to update the sensor. Press  to confirm selection. The sensor firmware update wizard appears.



The wizard guides the user through the sensor firmware update in self-explanatory steps.

Use   and highlight 'Next' then press  to confirm selection. A hint appears indicating the expected duration of the firmware update.



Use and highlight 'Next' then press to confirm selection.

#### Note

Ensure that at least two battery status LEDs on the wireless module light up continuously. This guarantees enough operating time for the sensor firmware update.

A further hint to ensure proper connection of the wireless module to the sensor appears on the screen.

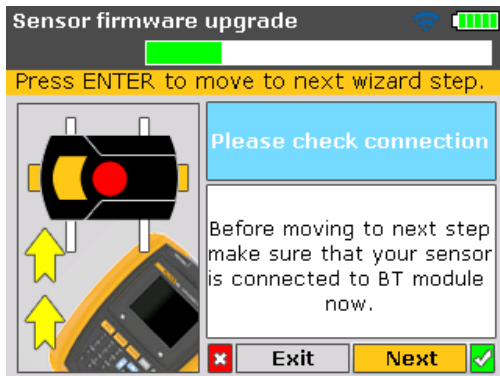

Use and highlight 'Next' then press to proceed with the sensor firmware update.

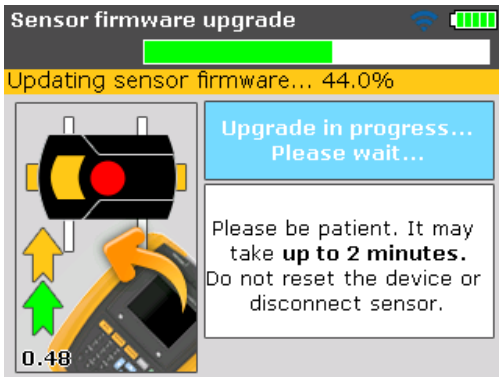

Once the sensor firmware update is finalised, the final update screen appears.

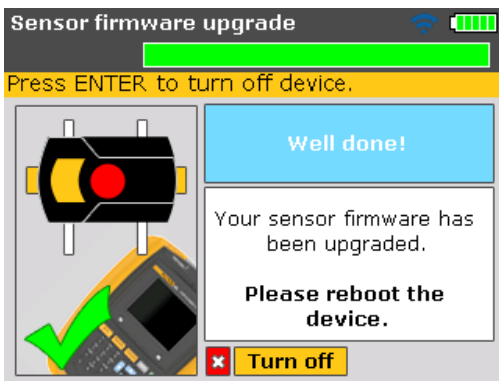

Restart the Product.

*Note*

*The sensor firmware update may also be carried out using the sensor cable. The sensor should be attached to the Product using the sensor cable as shown in Figure 7-5.*

## 830 Laser Alignment Tool technical data

### Product

CPU	Intel XScale PXA270 running at 312 MHz
Memory	64 MB RAM, 32 MB Flash
Display	Type: TFT, transmissive (sunlight-readable), 65 535 colours, backlit LED Integrated light sensor for automated adjustment of the brightness to the display according to the lighting conditions hence extending battery life Resolution: 320 x 240 Pixel Dimensions: 3.5 inch [8.9 cm] diagonal Keyboard elements: SETUP, MEASURE, DIAGNOSE, MENU, CLEAR, ENTER, BACK keys, Navigation cursor cross, alphanumeric keyboard and on/off button
LED indicators	Multicolour LED for laser status and alignment condition Multicolour LED for battery status
Power supply	Integrated Lithium-ion polymer rechargeable battery: 7.4 V / 2.6 Ah with typical operating time of 17 hours (based upon an operating cycle of 33% measurement, 33% computation and 33% 'sleep' mode)
External interface	USB host USB device (slave) RS232 (serial) for sensor AC adapter/charger socket
Environmental protection	IP 65 (dustproof and water spray resistant), shockproof Relative humidity 10% to 90%
Temperature range	Operation: -10°C to 50°C [14°F to 122°F] Storage: -20°C to 60°C [-4°F to 140°F]
Altitude	2000 m [6500 ft]
Dimensions	Approx. 220 x 165 x 45 mm [8.7" x 6.5" x 1.8"]
Weight	742 g [1.64 lb]

### Sensor

Particulars	Measurement principle: Coaxial, reflected laser beam Environmental protection: IP 67 (submersible, dustproof) Ambient light protection: yes Storage temperature: -20°C to 80°C [-4°F to 176°F] Operating temperature: 0°C to 55°C [32°F to 131°F] Dimensions: approx. 107 x 70 x 49 mm [4 1/4" x 2 3/4" x 2"] Weight: approx. 177 g [6 1/2 oz.]
Laser	Type: AlGaInP semiconductor laser Beam divergence: < 0.35 mrad Wavelength (typical): 670 nm (red, visible) Beam power: < 1 mW
Detector	Measurement area: unlimited, dynamically extendible Resolution: 1 µm Accuracy (avg): > 98%
Inclinometer	Measurement range: 0° to 360° Resolution: <1°

**Prism**

Particulars                      Type: 90° roof prism  
Accuracy (avg): > 99%  
Environmental protection: IP 67 (submersible, dustproof)  
Storage temperature: -20°C to 80°C [-4°F to 176°F]  
Operating temperature: -20°C to 60°C [-4°F to 140°F]  
Dimensions: approx. 100 x 41 x 35 mm [4" x 1 5/8" x 1 3/8"]  
Weight: approx. 65 g [2 1/2 oz.]

**Wireless module**

Particulars                      Class 1 connectivity, transmitting power 100 mW  
Transmission distance: 10 m [33 ft.]  
Complies with FCC rules part 15.247  
LED indicators: 1 LED for Bluetooth communication,  
3 green LEDs for battery status  
Power supply: Batteries 2 x 1.5 V IEC LR6 ("AA")  
Operating time: 14 hours typical use (based upon an operating cycle  
of 50% measurement, 50% standby)  
Storage temperature: -20°C to 60°C [-4°F to 140°F]  
Operating temperature: -10°C to 50°C [14°F to 122°F]  
Environmental protection: IP 65 (dustproof and water spray resistant),  
shockproof  
Dimensions: Approx. 81 x 41 x 34 mm [3 1/8" x 1 11/16" x 1 5/16"]  
Weight: Approx. 133 g [4.7 oz.] including batteries and cable

**Safety**

Electrical                      IEC 61010-1  
Battery                         IEC 62133  
Laser                         IEC 60825-1, 21 CFR 1040.10, .11 with Laser Notice 50

**Electromagnetic Environment**

Particulars                      IEC 61326-1: Basic

**Radio Frequency Emissions**

Particulars                      IEC CISPR 11: Group 1, Class A.  
Group 1 have intentionally generated and/or use conductively coupled  
radio-frequency energy which is necessary for the internal functioning  
of the equipment itself.  
Class A equipment is suitable for use in non-domestic locations and/or  
directly connected to a low-voltage power supply network.

**Carrying case**

Particulars                      Case dimensions: approx. 560 x 330 x 130 mm [22 3/64" x 13" x 7 1/8"]  
Weight, including all standard parts: approx. 4.8 kg [10.6 lb]

## Suggested shaft alignment tolerances

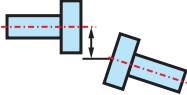
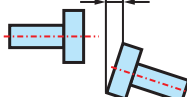
	[RPM]	metric [mm]		inch [mils]	
Soft foot	any	0.06 mm		2.0 mils	
Short "flexible" couplings <b>Offset</b> 		Acceptable ■	Excellent ■	Acceptable ■	Excellent ■
	600			9.0	5.0
	750	0.19	0.09		
	900			6.0	3.0
	1200			4.0	2.5
	1500	0.09	0.06		
	1800			3.0	2.0
	3000	0.06	0.03		
	3600			1.5	1.0
	6000	0.03	0.02		
	7200			1.0	0.5
<b>Angularity</b> coupling gap difference per 100 mm or 10" diameter 	600			15.0	10.0
	750	0.13	0.09		
	900			10.0	7.0
	1200			8.0	5.0
	1500	0.07	0.05		
	1800			5.0	3.0
	3000	0.04	0.03		
	3600			3.0	2.0
	6000	0.03	0.02		
7200			2.0	1.0	



## **Declaration of conformity**

*Note*

*Any amendments to the issued certificate will be posted on the FLUKE website – [www.fluke.com](http://www.fluke.com).*

*Please visit the website on a regular basis for information on new and current products.*

Page intentionally left blank

## **Index**

### **A**

Alignment condition LED 44, 72  
Averaging 104

### **B**

Bar scale  
  green 40  
Battery capacity 27  
Bolt correction 118  
Brackets  
  mounting 48

### **C**

Cable connection  
  test 122  
Calibration 10  
Care 10  
Chain-type bracket 21  
Charging battery 15  
'Clock' mode 41  
Clock mode 68, 101  
'Compass' mode 41  
Compass mode 68, 101  
Conformity certificate 137  
Contact  
  telephone numbers 1  
  website 1  
Coupling backlash 47  
Coupling tolerance table 59

### **D**

Data management 35  
Data storage  
  note 9  
Default measurement mode 34  
Default RPM 33  
Default settings 33  
Device settings 26  
Diagnose 45, 70  
Dimensions  
  machine 39, 54  
  negative entries 57  
Display brightness 26  
Disposal 11  
  WEEE Directive 3

### **E**

Extend 79  
  measurement range 70  
Extending  
  measurement range 102

### **F**

File  
  overwrite name 83  
  save 81  
Firmware  
  downloading 124  
  update procedure 125  
Firmware update 124  
Flange configuration  
  editing 111  
Flange patterns 111  
Flashing process 128  
Foot correction 71

### **G**

Gap 71

### **I**

IP classification 7

### **J**

Job preparation 47

### **K**

Keyboard beep 26

### **L**

Laser beam  
  center 44  
Laser beam adjustment 60  
Laser END 70  
Laser OFF 70  
Laser safety 7  
Live Move  
  horizontal 75  
  vertical 78

**M**

Machine properties 58  
Machine set-up 58  
Measurement mode 41  
    'Clock' 34  
    'Compass' 34  
Measurement options 42, 61, 101

**O**

Offset 71

**P**

Package items 5  
PDF file 84  
Power scheme 27  
Printer  
    configure 86  
Printer configuration 34  
Printing options 87  
Printing reports 84  
Prism 20  
    mounting 50  
Prism knob 52

**R**

Reference diameter 33  
Regional settings 29  
Repeatability  
    poor 80  
Report  
    save as PDF 84  
Resume policy 28  
RPM 59

**S**

Safety information 2  
Scan 43  
Sensor 18  
    clamping screw 121  
    connecting 52  
    locking knob 121  
    mounting 50  
    screw-type locking 121

Sensor cable 121  
    disconnecting 53  
Sensor firmware  
    update 131  
Sensor selection 42, 61, 123  
Shimming 73  
Sign convention 71  
    vertical machines 117  
Soft foot 47, 48  
    angular 91, 92  
    checking 92  
    induced 92  
    parallel 91, 92  
    principal causes 91  
    types 92  
Storage 10  
Switching on 53  
Symbols 3

**T**

Technical data  
    830 Laser Alignment Tool 134  
Tolerance bar 46  
    colour-coded 72, 95  
    marker 95  
    marking 72  
Tolerances 72  
Tolerance table 34, 73, 136  
Torsion play 68

**U**

Universal adapter/charger 17

**V**

Vertical machine  
    typical configuration 107  
Vertical machines  
    mounting components 109

**W**

WEEE 124  
Wireless communication  
    establishing 61  
Wireless measurement 41

Wireless module 22  
  delete 64  
  LED indicators 23  
  mounting 50  
  scan 62  
Wireless module cable 121

