

DETAILS

Product Number	C14116_STRADA-2X2-PX
Family	Strada-Module
Type	Lens
Color	clear
Diameter	50x50 mm
Height	8 mm
Style	square
Optic Material	PMMA
Holder Material	
Fastening	screw, pin
Status	ready
ROHS Compliant	Yes
Date Updated	23/02/2015



OPTICAL PROPERTIES

LED	Viewing Angle	Light Beam	Efficiency	cd/lm	Connector
TL1L3	Asym deg	Asymmetric	94 %	0.760	-
XT-E	Asymmetric deg	Asymmetric	94 %	0.950	-
XM-L2	Asymmetric deg	Asymmetric	94 %	0.790	-
XM-L	Asymmetric deg	Asymmetric	94 %	0.770	-
XP-G2	Asymmetric deg	Asymmetric	94 %	1.000	-
Z5P	Asymmetric deg	Asymmetric	94 %	1.130	-
Oslon Square PC	Asymmetric deg	Asymmetric	94 %	1.100	-
Oslon SSL 150	Asymmetric deg	Asymmetric	94 %	1.300	-
XB-D	Asymmetric deg	Asymmetric	94 %	1.000	-
Oslon SSL 80	Asymmetric deg	Asymmetric	94 %	1.300	-
NCSxx19B	Asymmetric deg	Asymmetric	94 %	1.120	-
LUXEON T	Asymmetric deg	Asymmetric	94 %	0.990	-
LUXEON Rebel ES	Asymmetric deg	Asymmetric	94 %	1.050	-
XP-E	Asymmetric deg	Asymmetric	94 %	1.200	-
Z5	Asymmetric deg	Asymmetric	94 %	1.300	-
LH351A(3535)	Asymmetric deg	Asymmetric	94 %	1.200	-
H35C0 (LEMWA33)	Asymmetric deg	Asymmetric	94 %	0.900	-
H35C1 (LEMWA33)	Asymmetric deg	Asymmetric	94 %	0.980	-
NS9x383	Asymmetric deg	Asymmetric	94 %	0.750	-
NVSxx19B/NVSxx19C	Asymmetric deg	Asymmetric	94 %	0.940	-
TL1L4	Asymmetric deg	Asymmetric	91 %	1.000	-
Fortimo FastFlex LED board 2x8/740 DA 03	Asymmetric deg	Asymmetric	94 %	1.100	-
Z5M1/Z5M2	Asymmetric deg	Asymmetric	94 %	1.000	-
Z5M	Asymmetric deg	Asymmetric	94 %	1.000	-
LH351Z	Asymmetric deg	Asymmetric	94 %	1.000	-

D

C

B

A

4

4

Cent. to cent.

Rear view

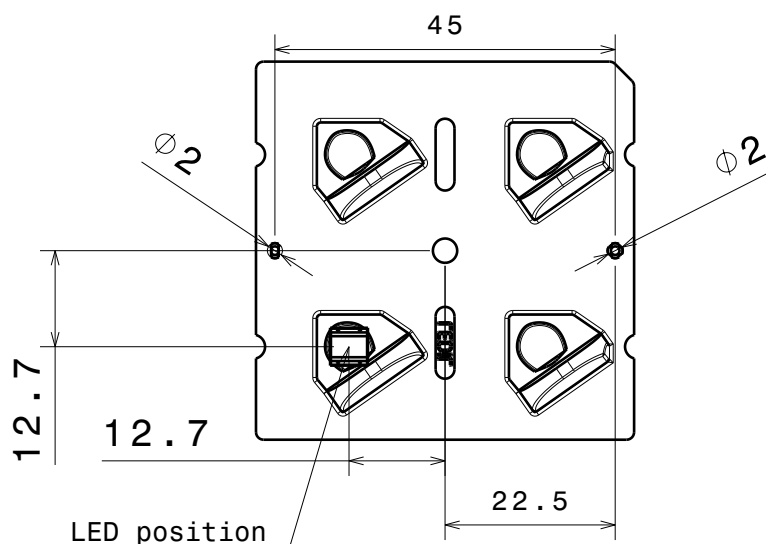
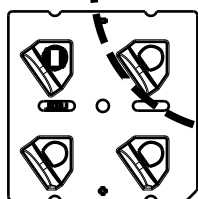
Beam asymmetric
direction

3

3

Bottom view

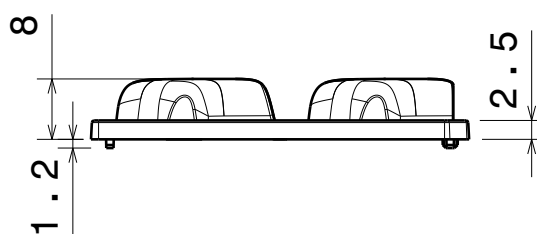

2

2

Front view

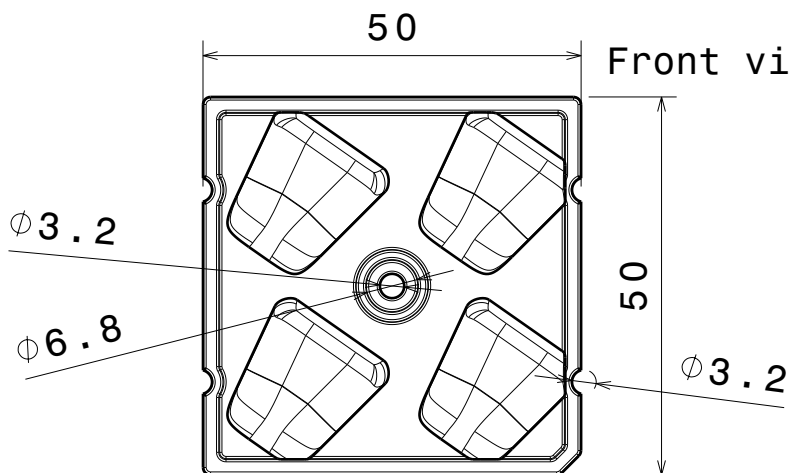

INDEX	PART NO	DESCRIPTION	MATERIAL	COLOUR
1	C14116	STRADA-2X2-PX	PMMA	clear

Tolerances if not otherwise shown
According to DIN ISO 2768-1
Linear measures:
Up to 30mm class M, otherwise class C.
According to DIN ISO 2768-2
Form and position: class L

LEDiL

Ledil Oy
Salorankatu 10
FIN 24240 SALO
Finland

THIRD ANGLE PROJECTION:

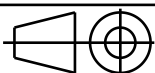

DRAWING TITLE

C14116_STRADA-2X2-PX

This drawing is the property
of LEDiL Oy. It may not be
reproduced, copied or
communicated without a written
agreement with LEDiL Oy.

SIZE PART NUMBER

A4

C14116

SCALE 1:1 WEIGHT

SHEET 1/1

D

A

1

Ledil C14116_STRADA-2X2-PX_(TL1L3) / LDC (Linear)

Luminaire: Ledil C14116_STRADA-2X2-PX_(TL1L3)

Lamps: 1 x Toshiba_TL1L3_2x2_(TL1L3-NW1.L)_387.773lm@250mA_CCT=5000K_P=2.829W_I=0.25A

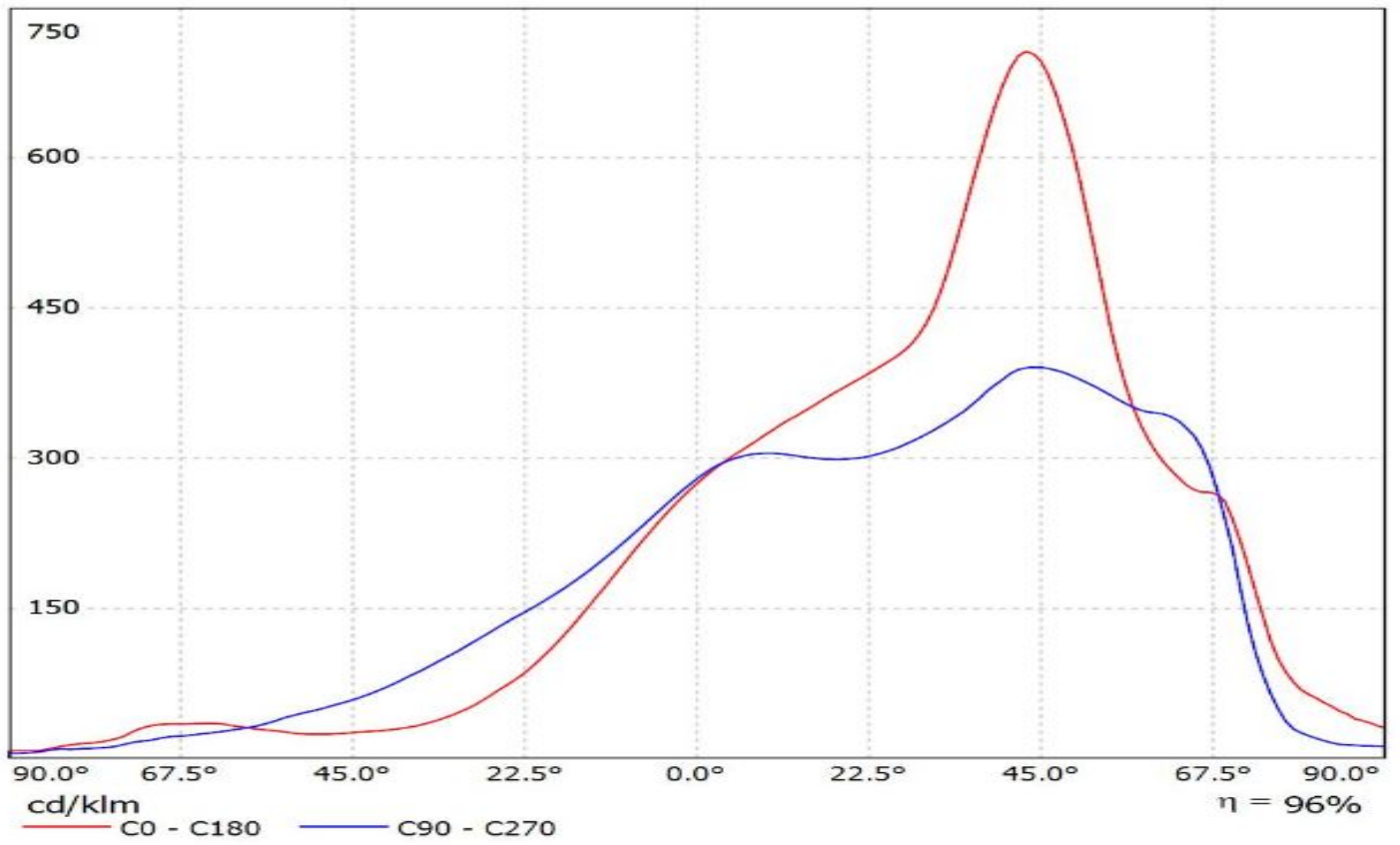

Luminaire: LEDiL Oy C14116_STRADA-2X2-PX_(XT-E)

Lamps: 1 x CREE_XT-E_2x2_390.75lm@250mA_CCT=5717K_P=2.99855W_I=249.9mA

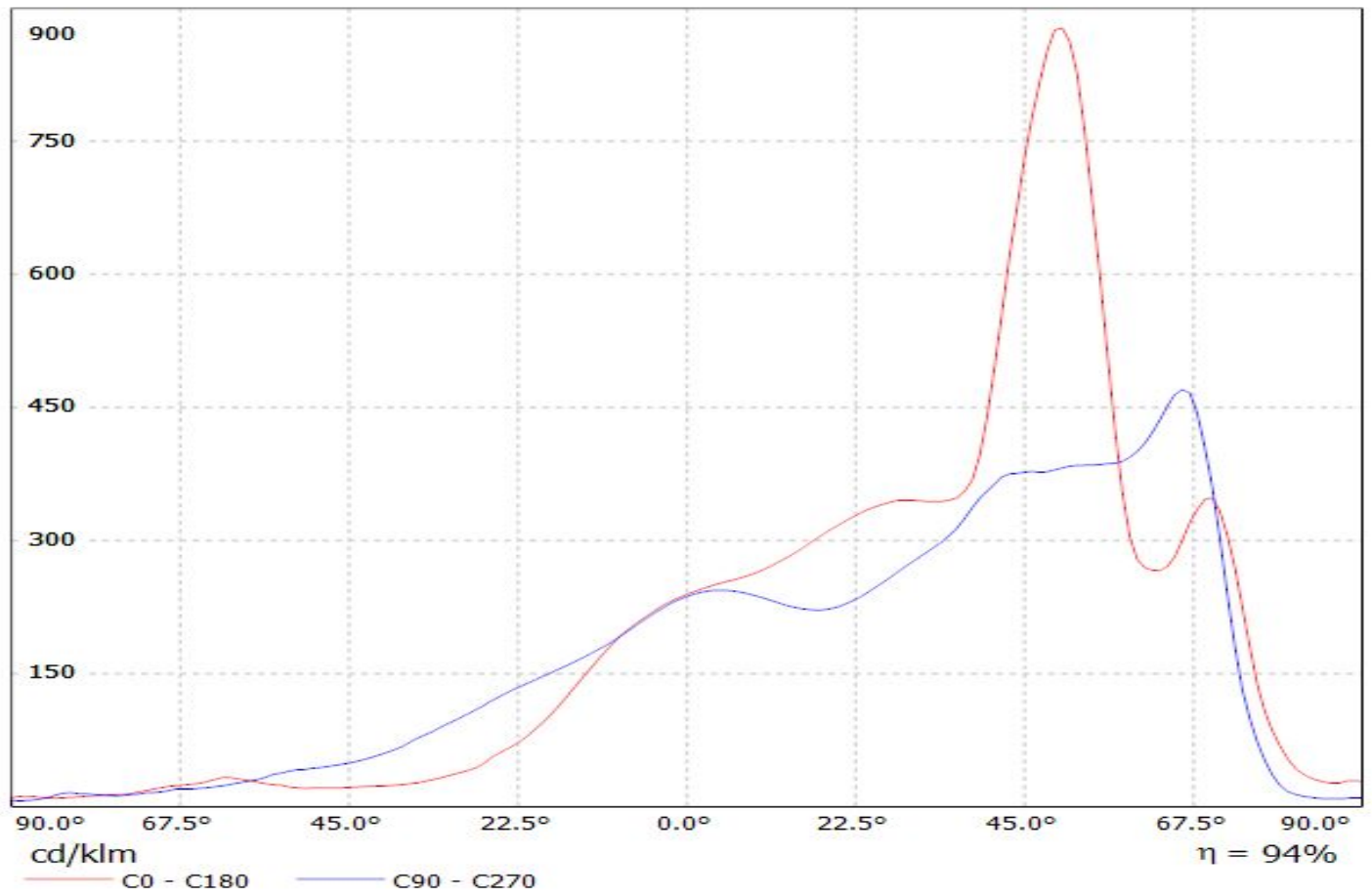

Luminaire: LEDiL Oy C14116_STRADA-2X2-PX_(XM-L2)
Lamps: 1 x CREE_XM-L2_2x2_(XMLBWT-0-7B4-T30-0L-001)
_361.65lm@250mA_CCT3220K_P=2.81924W_I=249.8mA

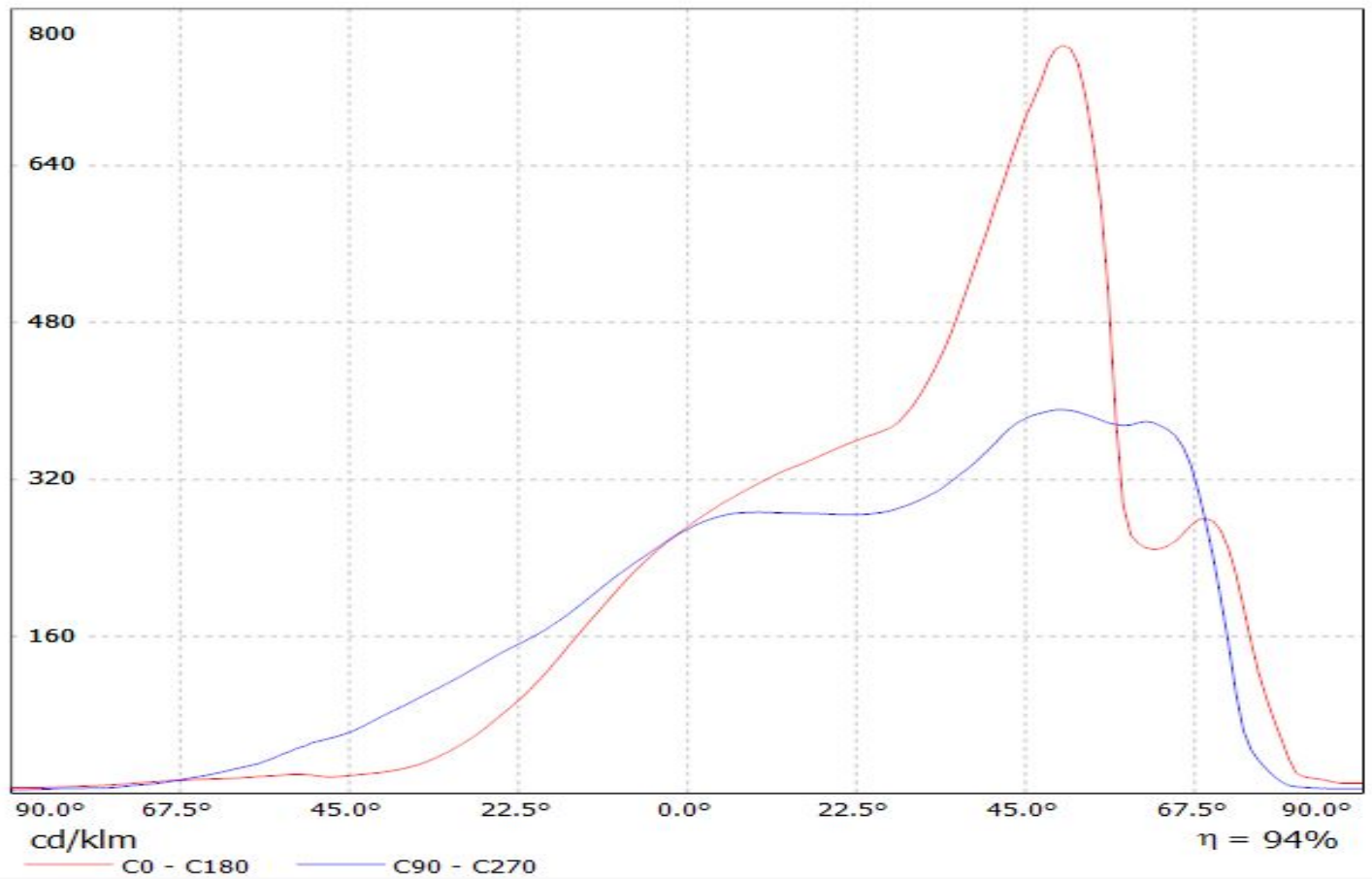

Luminaire: LEDiL Oy C14116_STRADA-2X2-PX_(XM-L)

Lamps: 1 x CREE_XM-L_2x2_362.5lm@250mA_CCT7700K_P=2.83911W_I=249.9mA

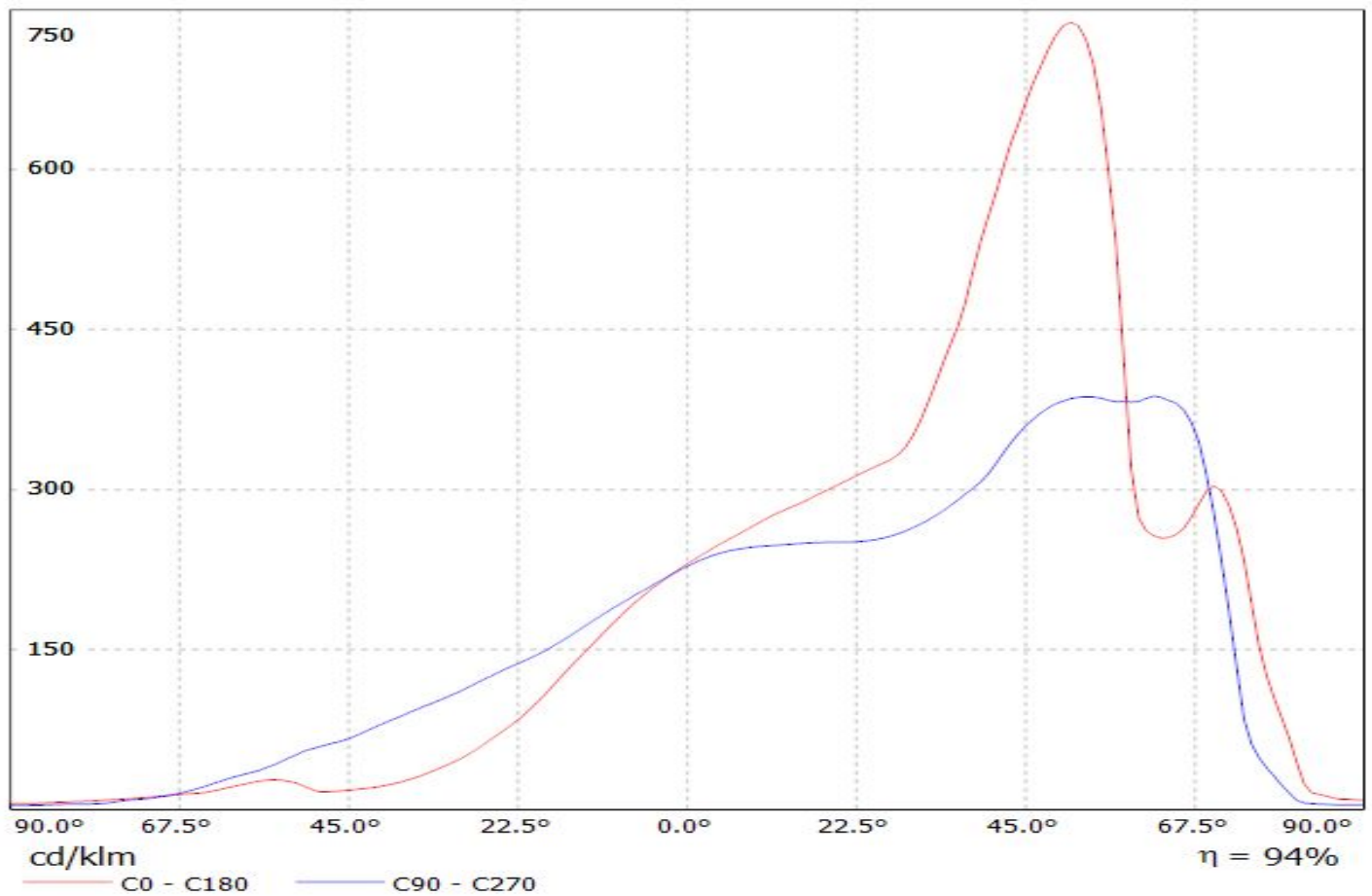

Luminaire: LEDiL Oy C14116_STRADA-2X2-PX_(XP-G2)
Lamps: 1 x CREE_XP-G2_2x2_(XPGBWT-L1-000-00G51)
_414.85lm@250mA_CCT=7181K_P=2.95563W_I=249.8mA

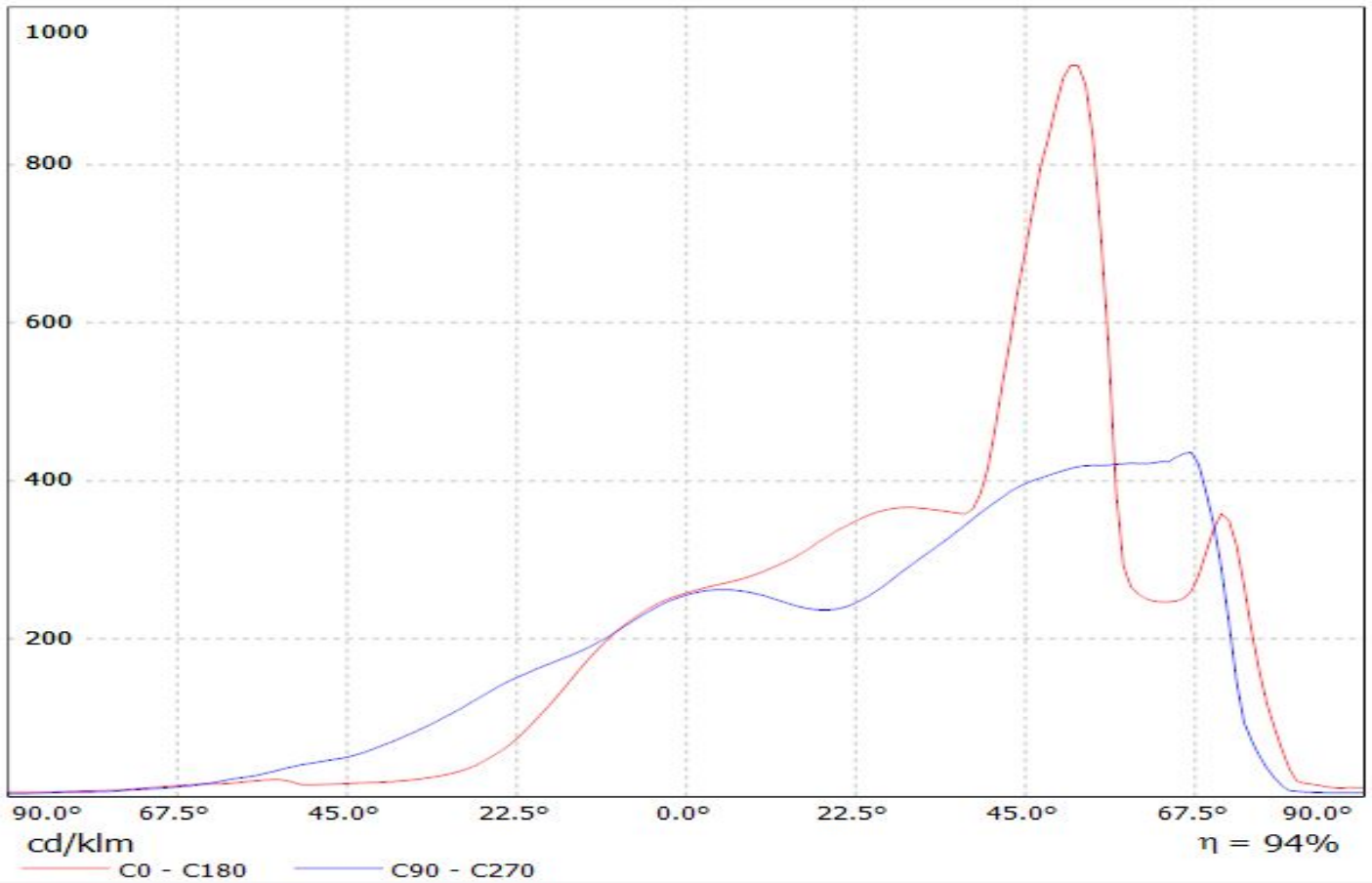

Luminaire: LEDiL Oy C14116_STRADA-2x2-PX_(Z5P)

Lamps: 1 x SEOUL_Z5P_2x2_286.1lm@250mA_P=3.66253W_I=249.9mA

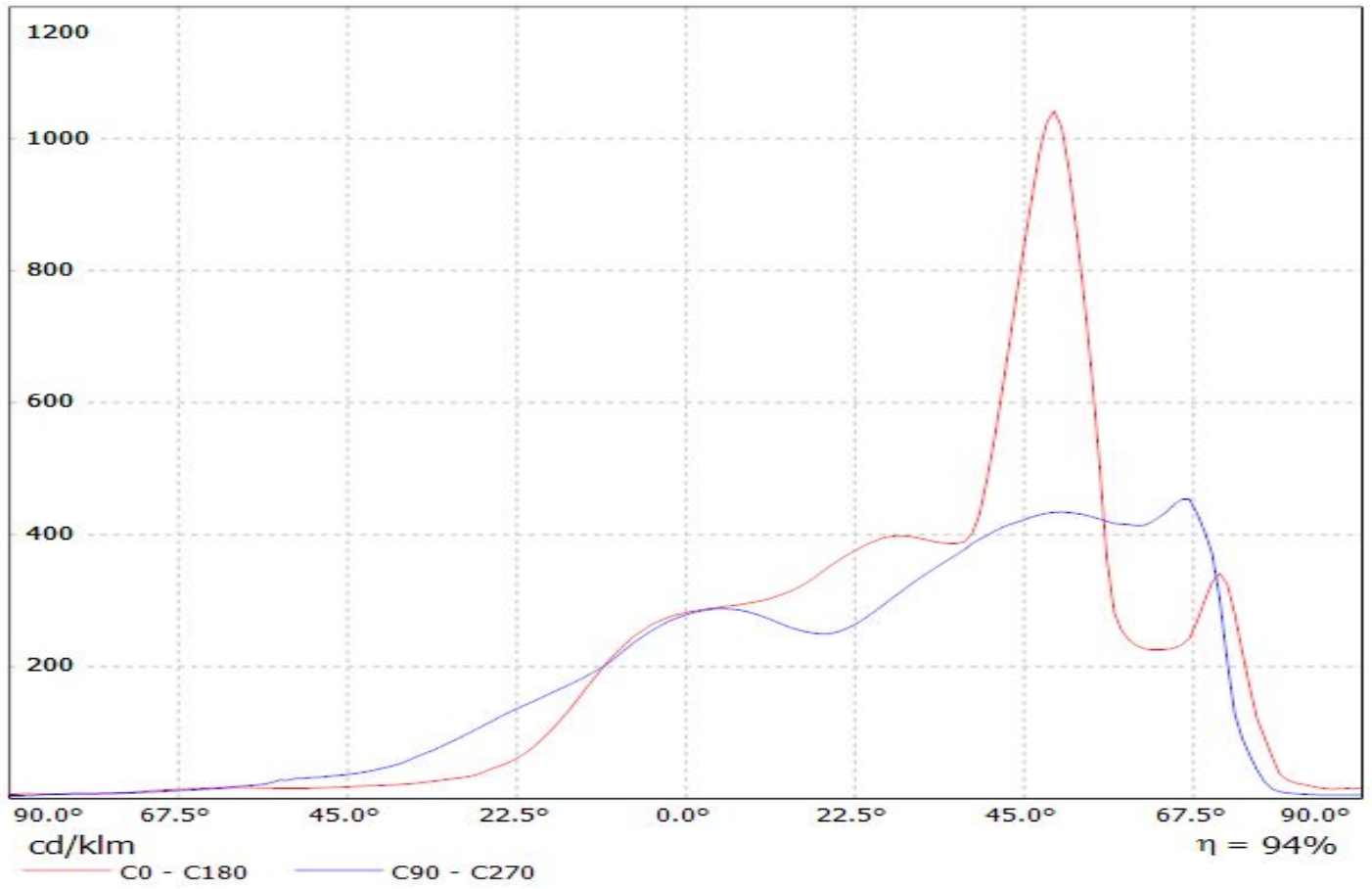

Luminaire: LEDiL Oy C14116_STRADA-2X2-PX_(SQ-PC)
Lamps: 1 x OSRAM_OSLON_SQUARE_PC_2x2_(LCW_CQAR.PC-MSMU-5H71-1)
_423.6lm@250mA_CCT=5960K_P=2.86246W_I=249.8mA

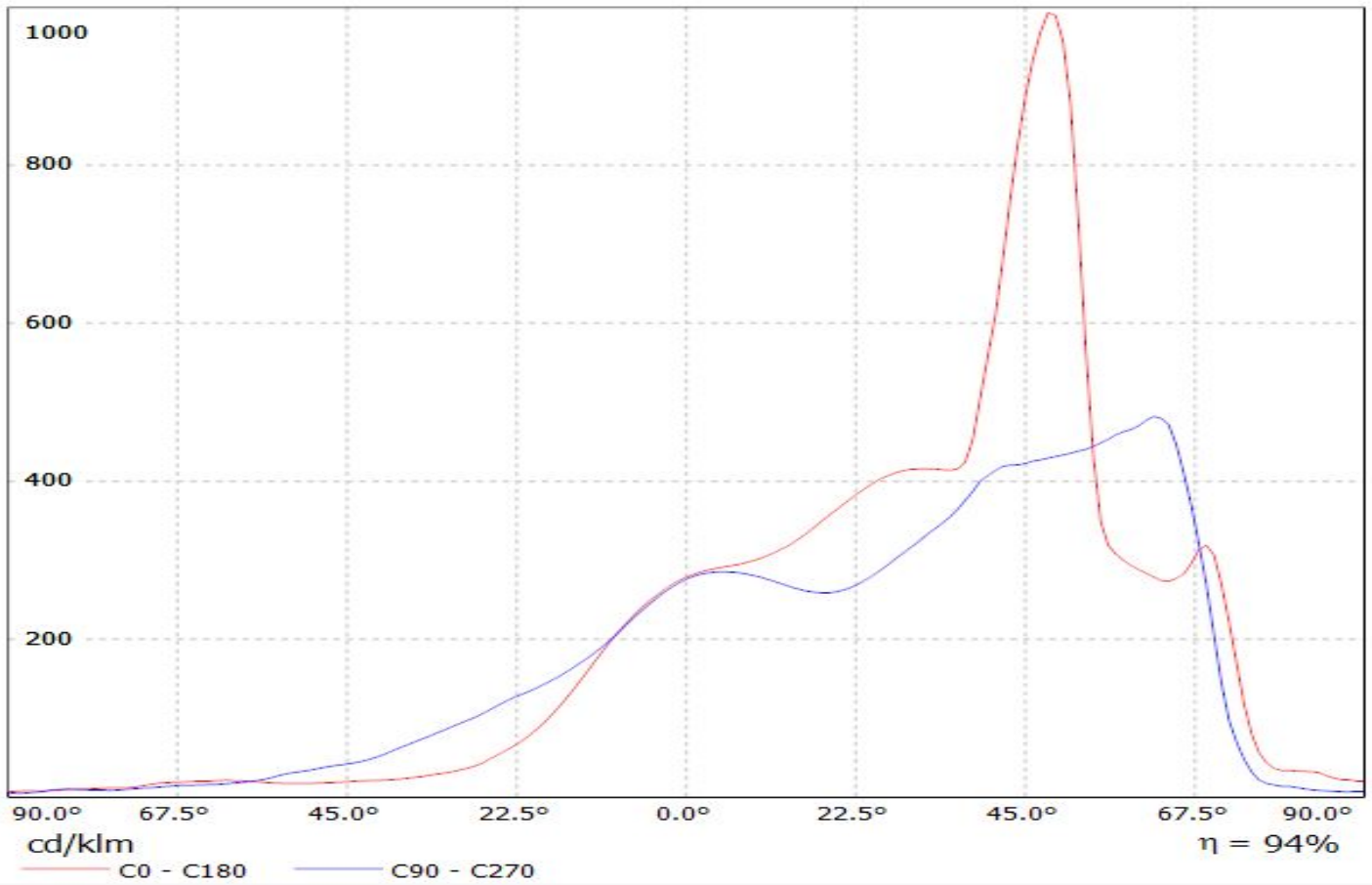

Luminaire: LEDiL Oy C14116_STRADA-2X2-PX_(SSL150)

Lamps: 1 x OSLO_N_SSL150_2x2_284.9lm@250mA_CCT=3154K_P=3.15274W_I=249.9mA

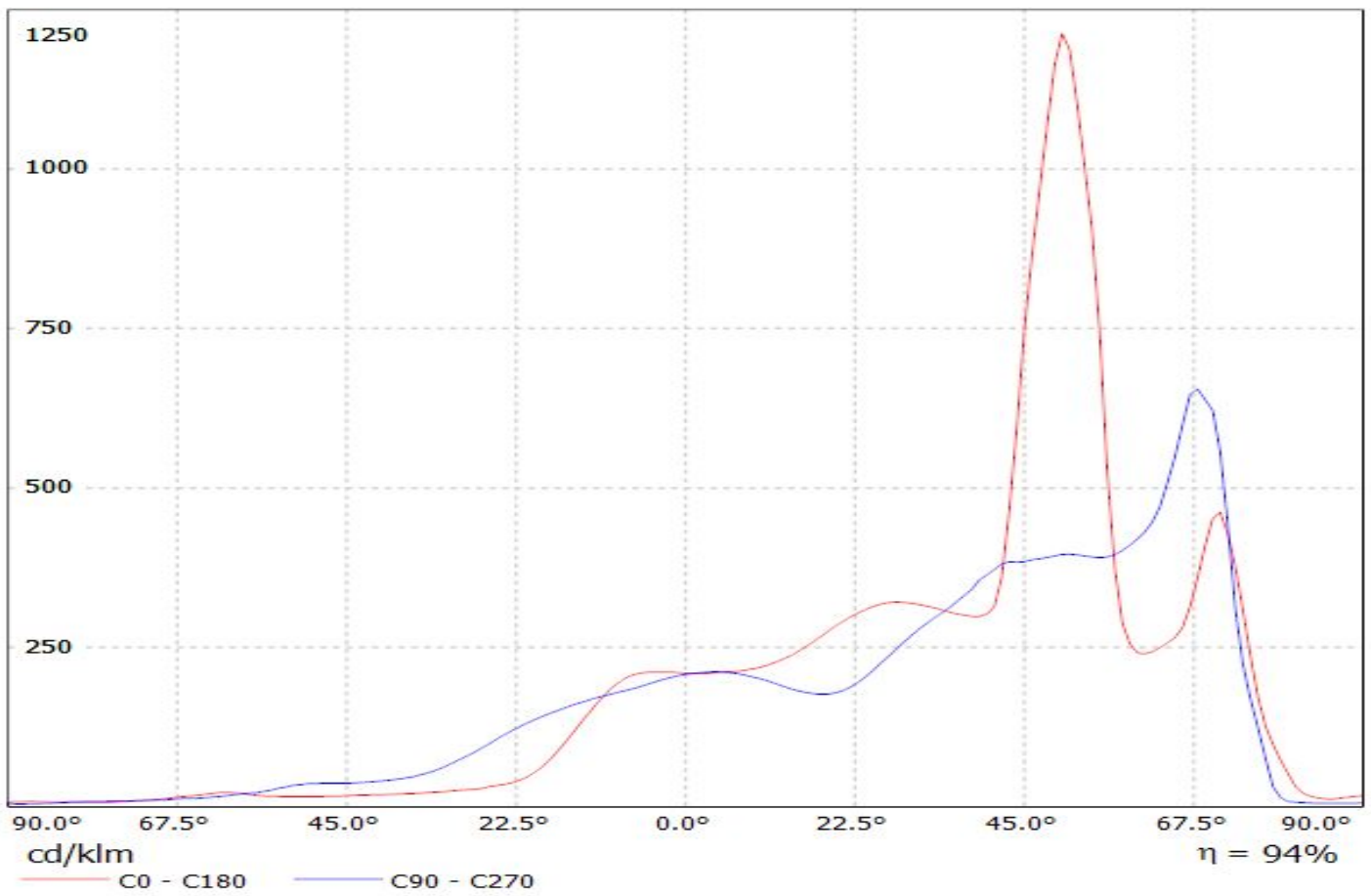

Luminaire: LEDiL Oy C14116_STRADA-2X2-PX_(XB-D)

Lamps: 1 x CREE_XB-D_2x2_366.34lm@250mA_P=3.07877W_I=249.9mA

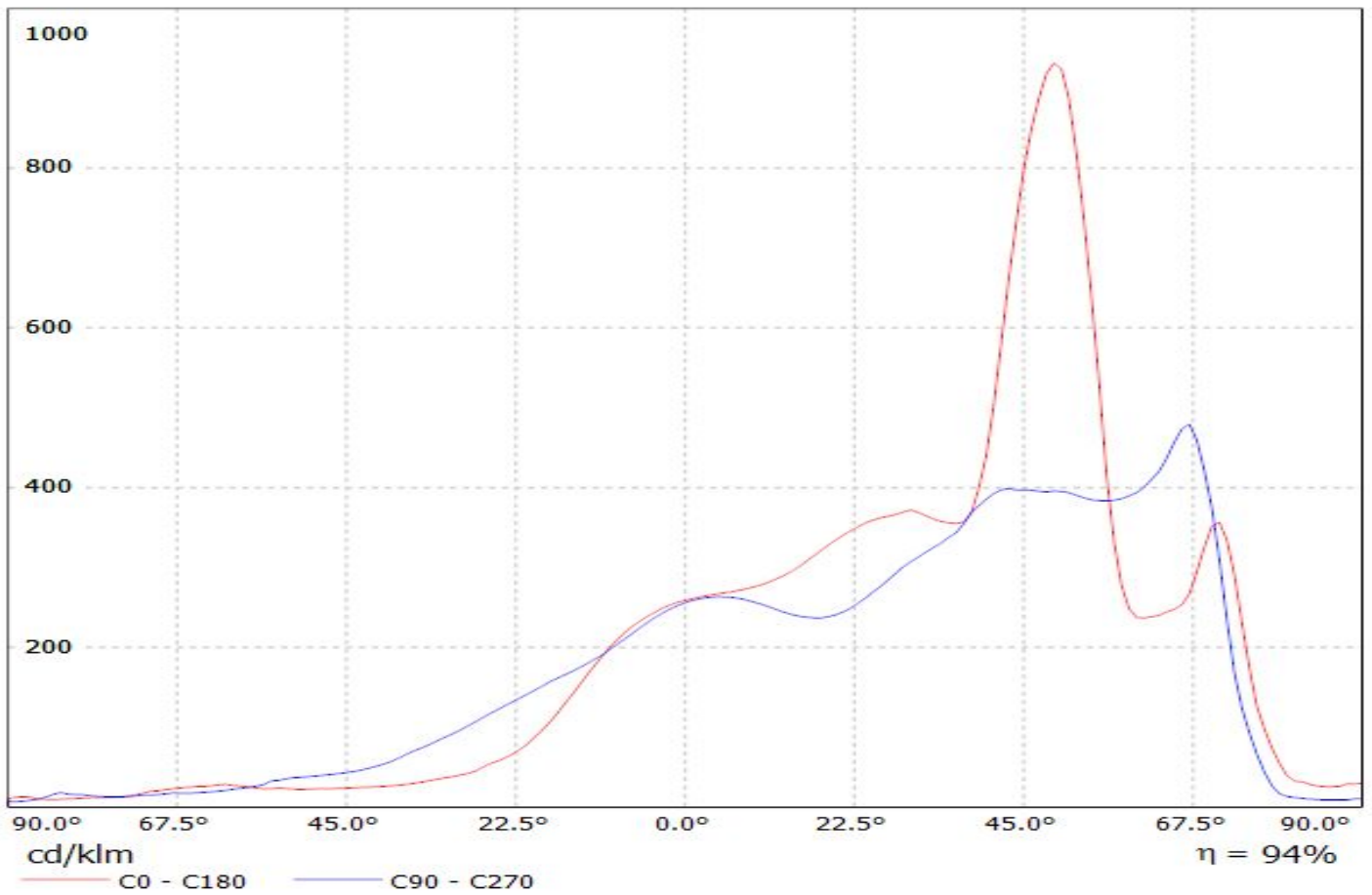

Luminaire: LEDiL Oy C14116_STRADA-2X2-PX_(SSL80)

Lamps: 1 x OSLO_N_SSL80_2x2_314.4lm@250mA_CCT=6775K_P=3.16548W_I=249.9mA

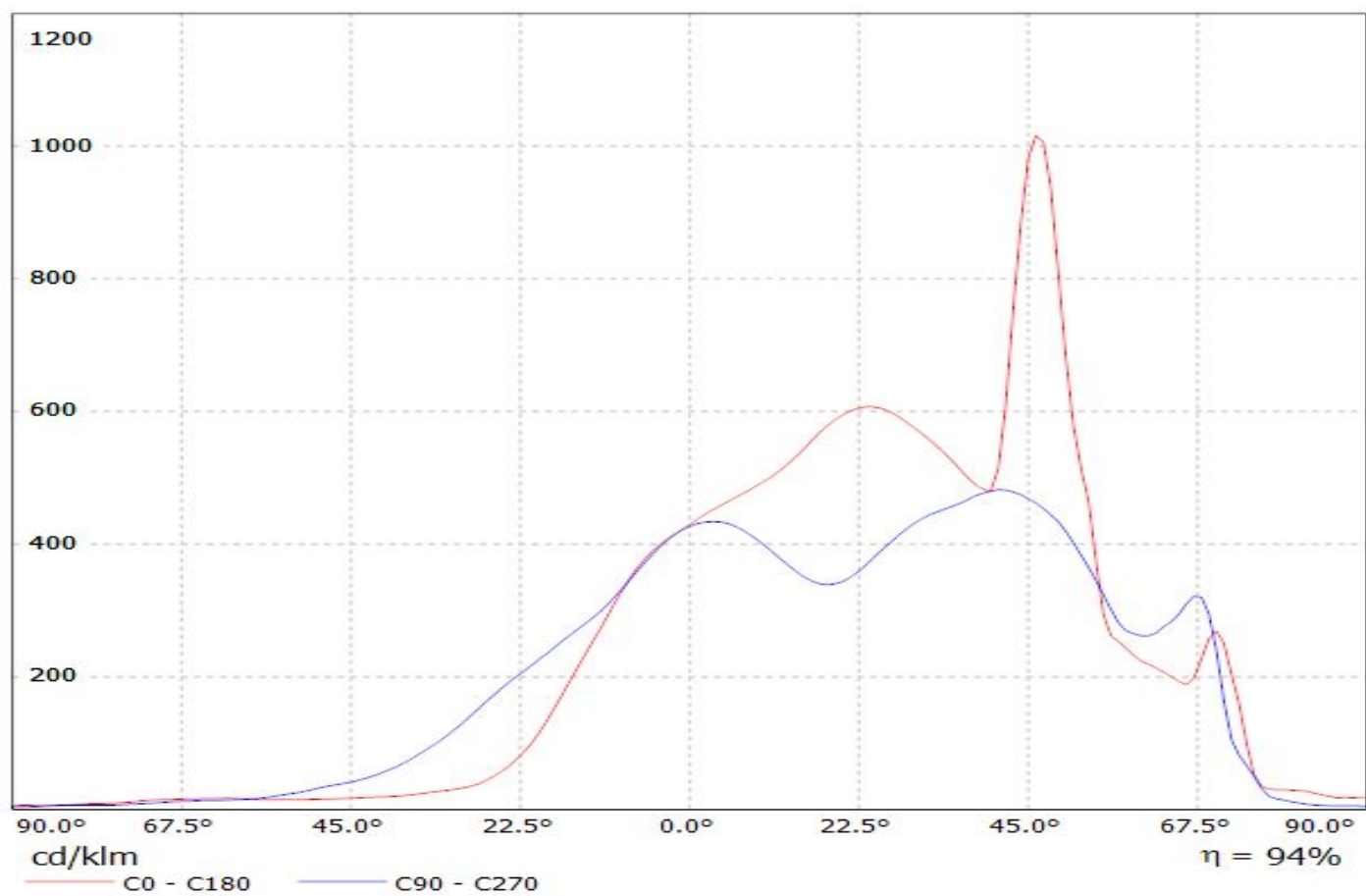

Luminaire: LEDiL Oy C14116_STRADA-2X2-PX_(NCSxx19B)
Lamps: 1 x NICHIA_NCSxx19B_(NCSW119BE)
_2x2_439.5lm@250mA_CCT=5403K_P=3.0083W_I=249.9mA

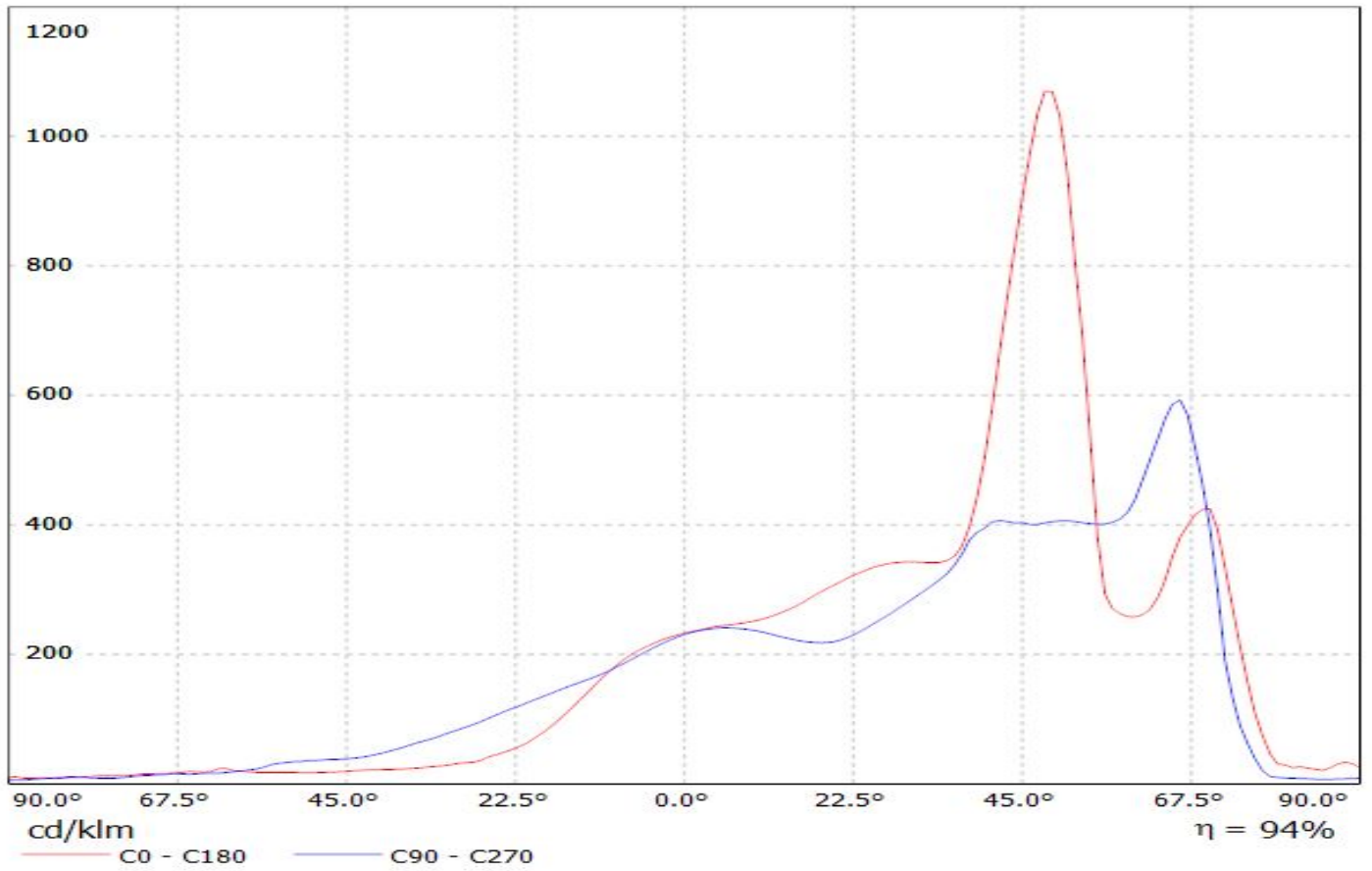

Luminaire: LEDiL Oy C14116_STRADA-2X2-PX (LUXEON_T)
Lamps: 1 x LUXEON_T_2x2_(LXH8-FW30-3)_294.67lm@250mA_P=2.806W_I=249.8mA

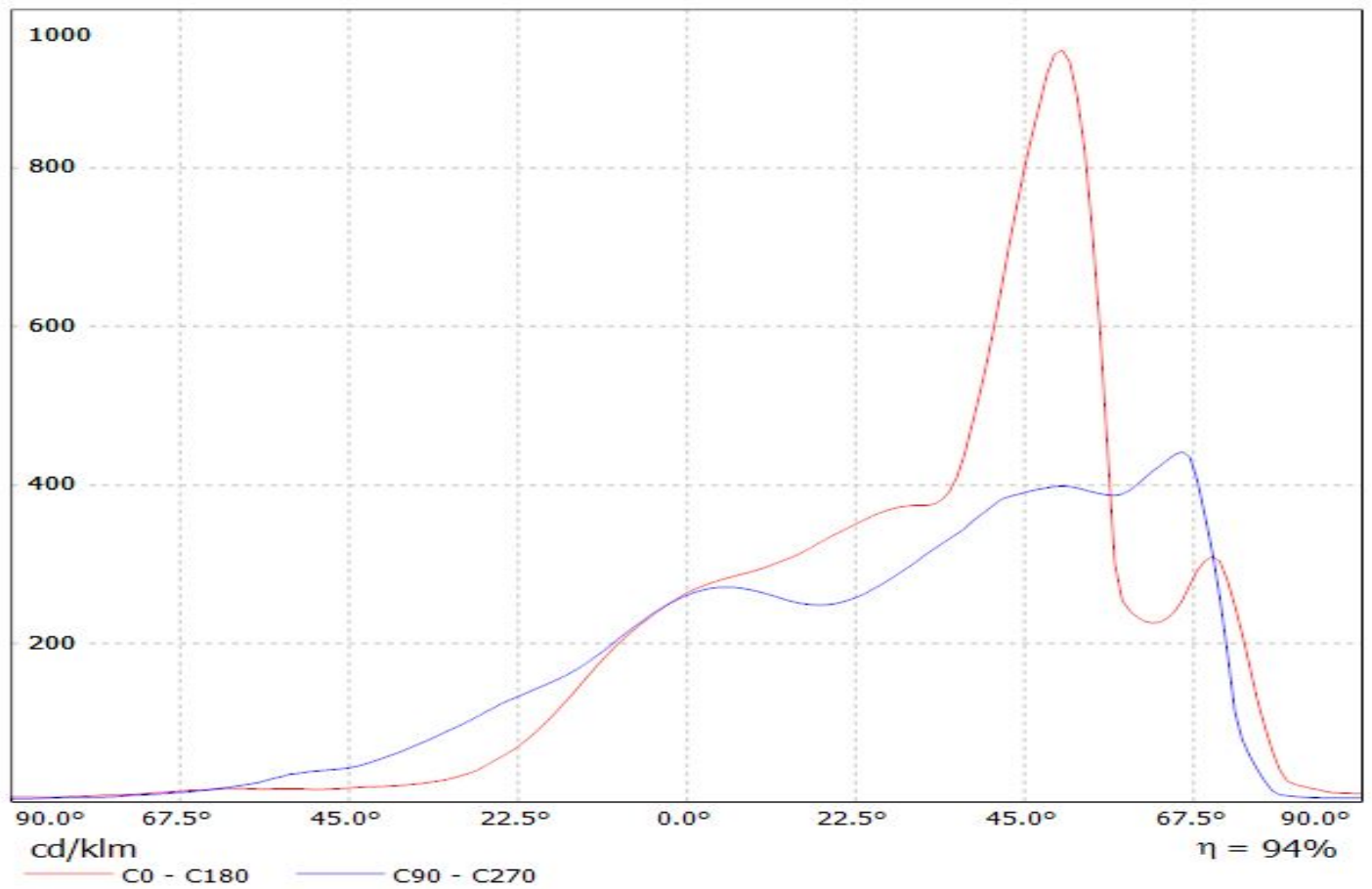

Luminaire: LEDiL Oy C14116_STRADA-2X2-PX_(REBEL_ES)

Lamps: 1 x LUXEON_REBEL_ES_2x2_340.26lm@250mA_P=2.87295W_I=249.8mA

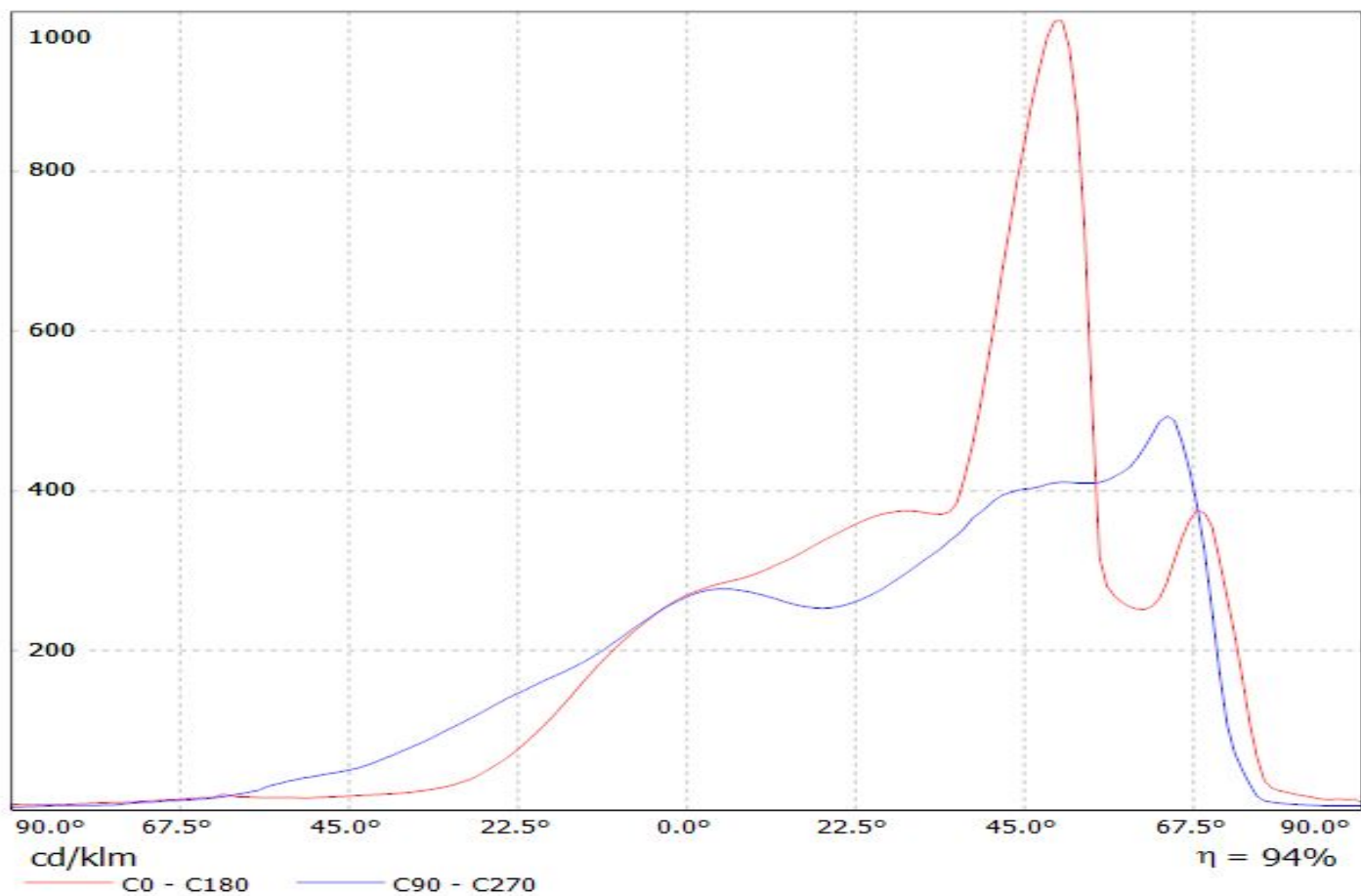

Luminaire: LEDiL Oy C14116_STRADA-2X2-PX_(XP-E)
Lamps: 1 x Cree_XP-E_2x2_(XPEWHT-L1-3C0-Q5-0-06)
_305.07lm@250mA_CCT=5434K_P=3.06902W_I=249.9mA

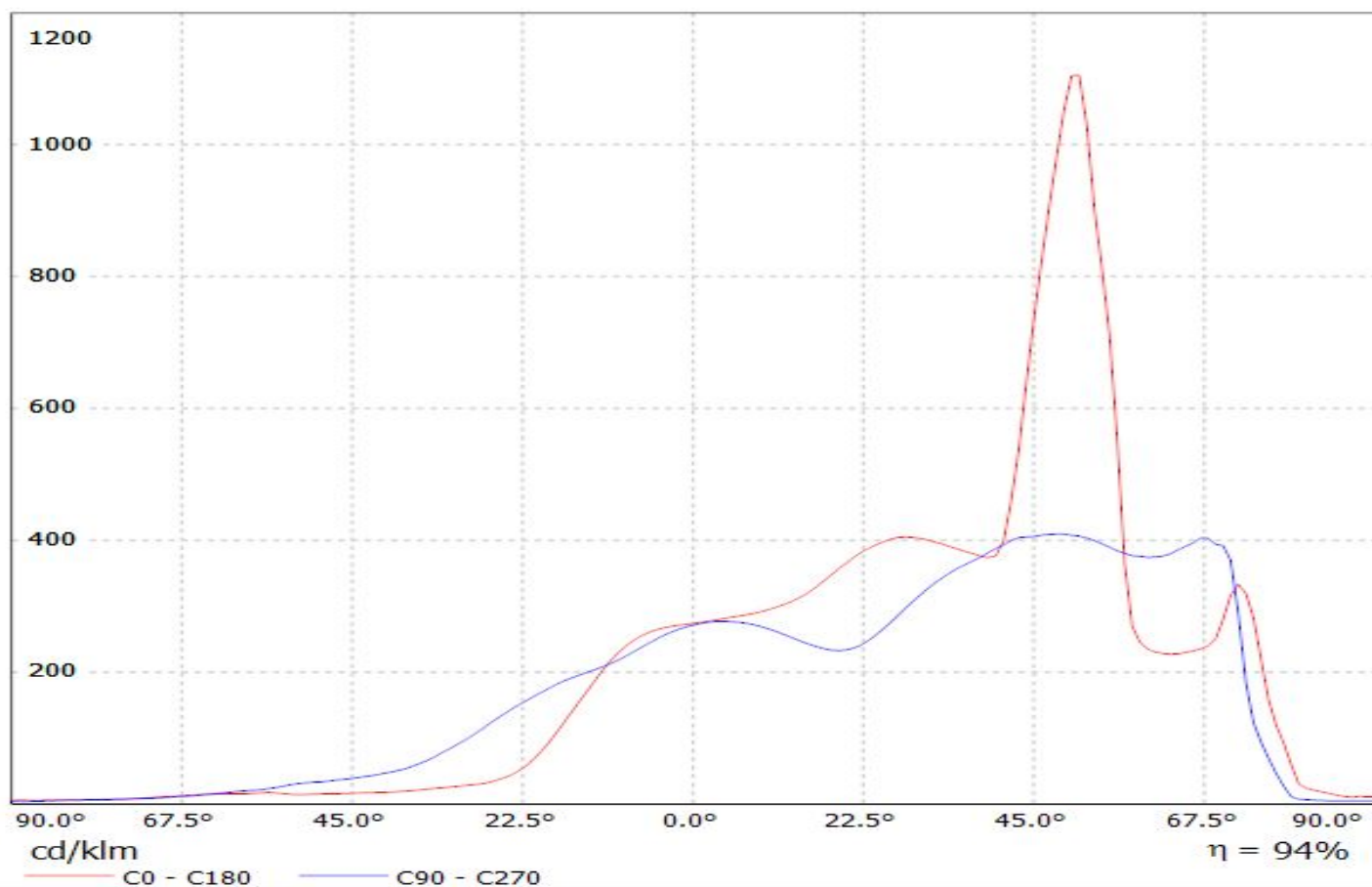

Luminaire: LEDiL Oy C14116_STRADA-2X2-PX_(Z5)

Lamps: 1 x SEOUL_Z5_(SZW05A0B)_339.3lm@250mA_P=3.01134W_I=249.8mA

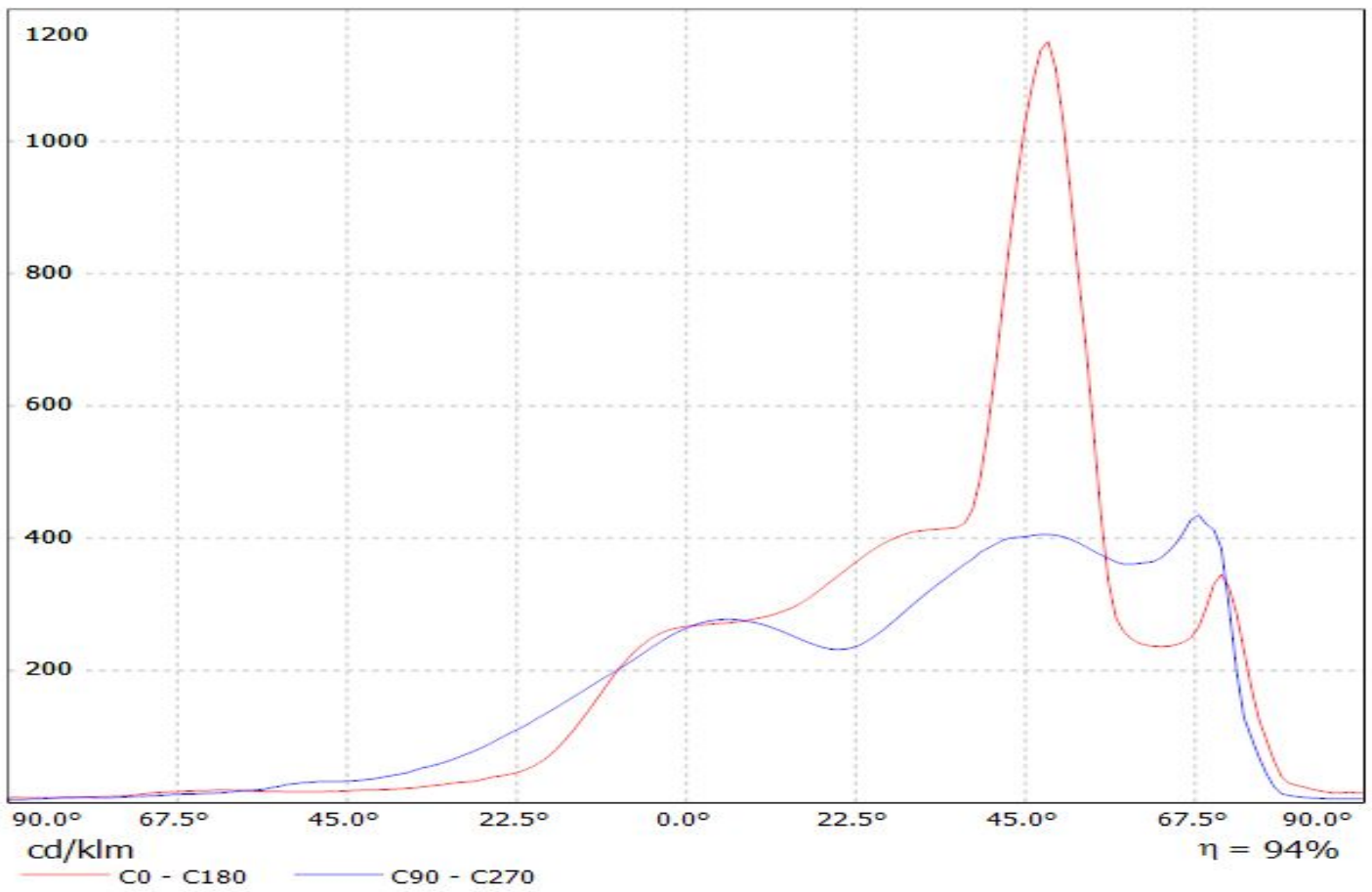

Luminaire: LEDiL Oy C14116_STRADA-2X2-PX_(LH351A)

Lamps: 1 x Samsung_LH351A_2x2_339.2lm@250mA_P=3.20997W_I=249.9mA

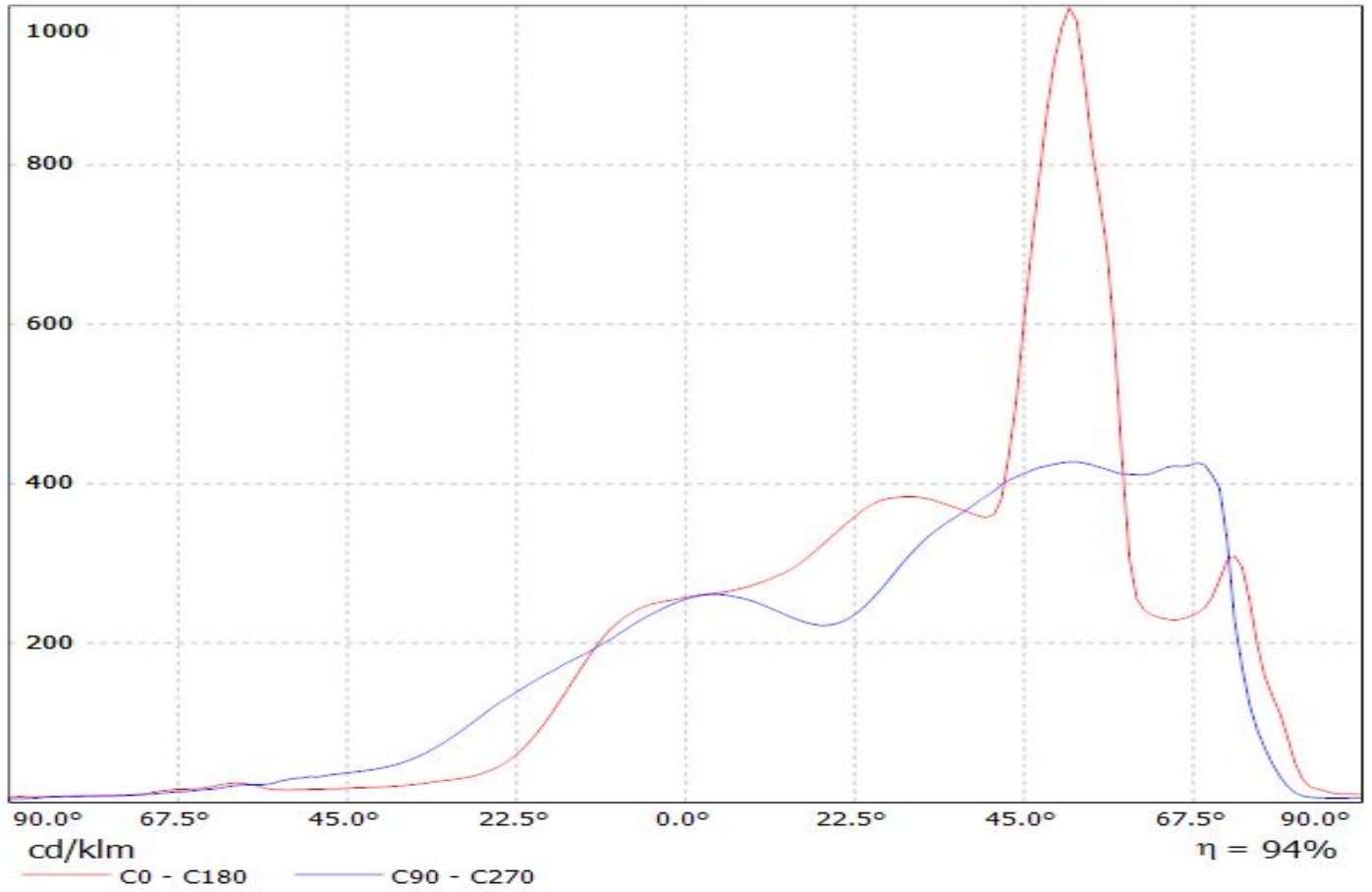

Luminaire: LEDiL Oy C14116_STRADA-2X2-PX_(H35C0)
Lamps: 1 x LG_H35C0_2x2_371.8lm@250mA_P=2.94332W_I=249.9mA

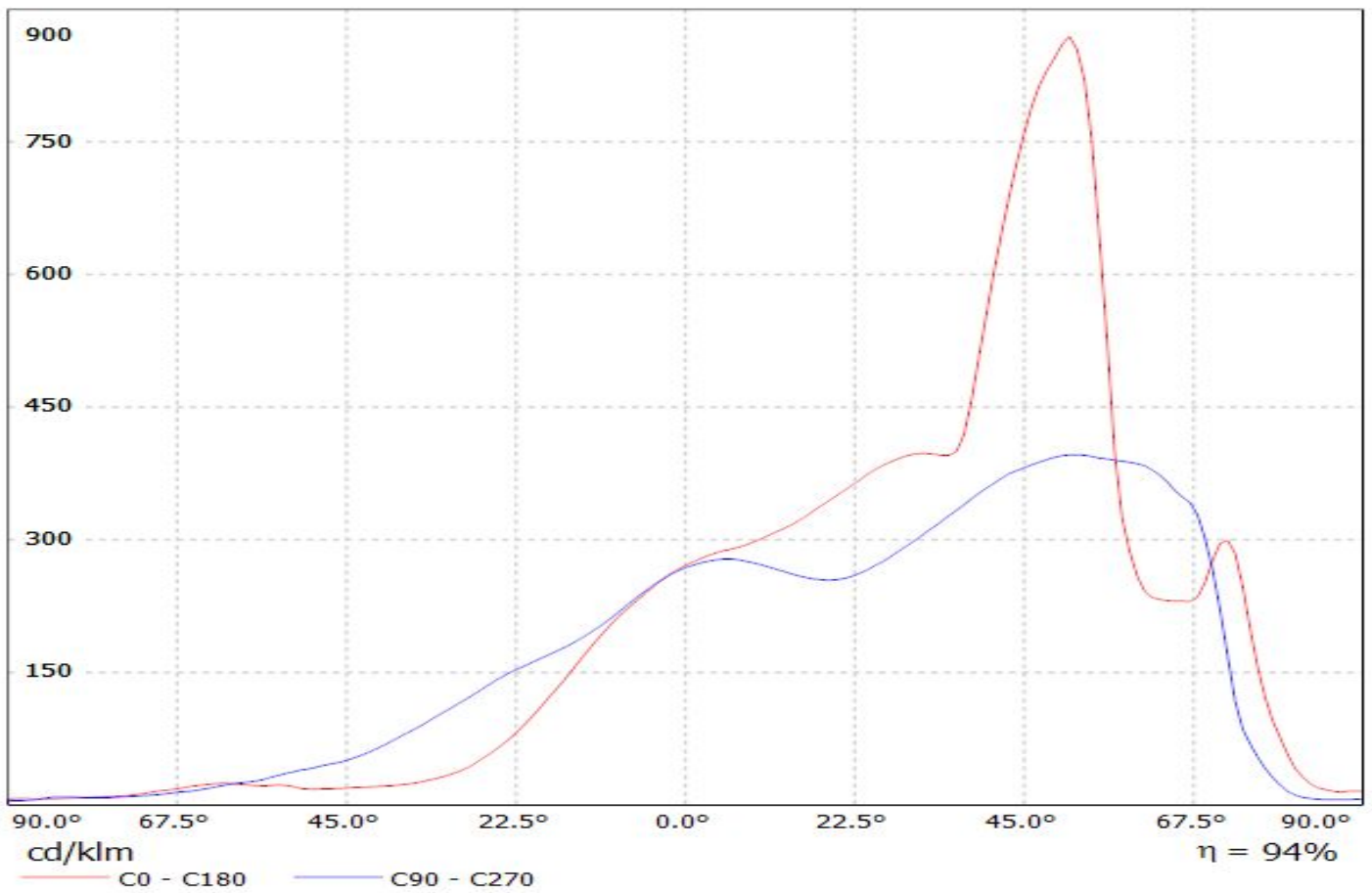

Luminaire: LEDiL Oy C14116_STRADA-2X2-PX_(H35C1)

Lamps: 1 x LG_H35C1_2x2_469.35lm@250mA_P=2.86535W_I=249.9mA

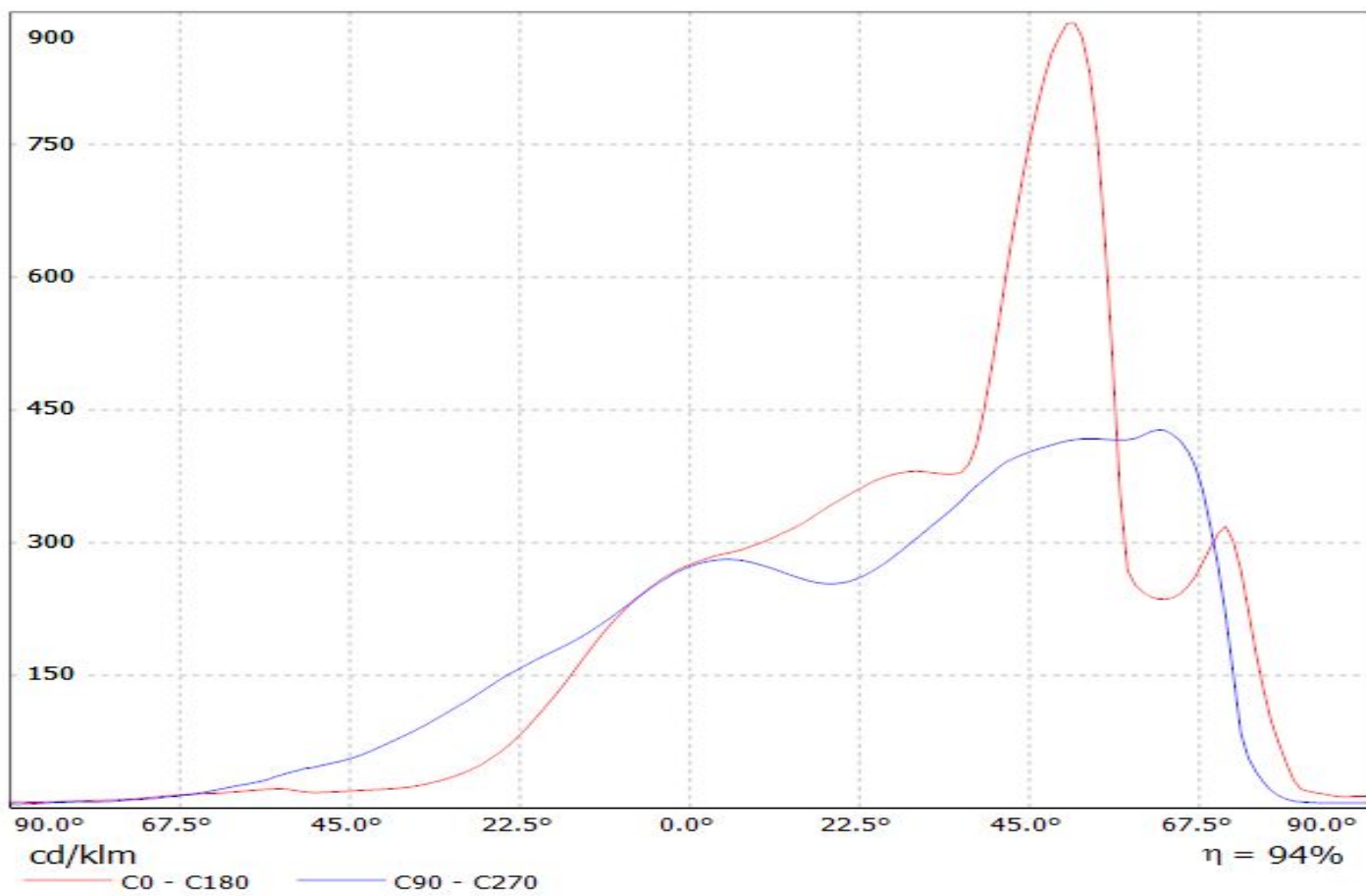

Luminaire: LEDiL Oy C14116_STRADA-2X2-PX_(NS9x383)

Lamps: 1 x NICHIA_NS9x383_(NS9W383T)_2x2_380.85lm@250mA_P=2.8856W_I=249.9mA

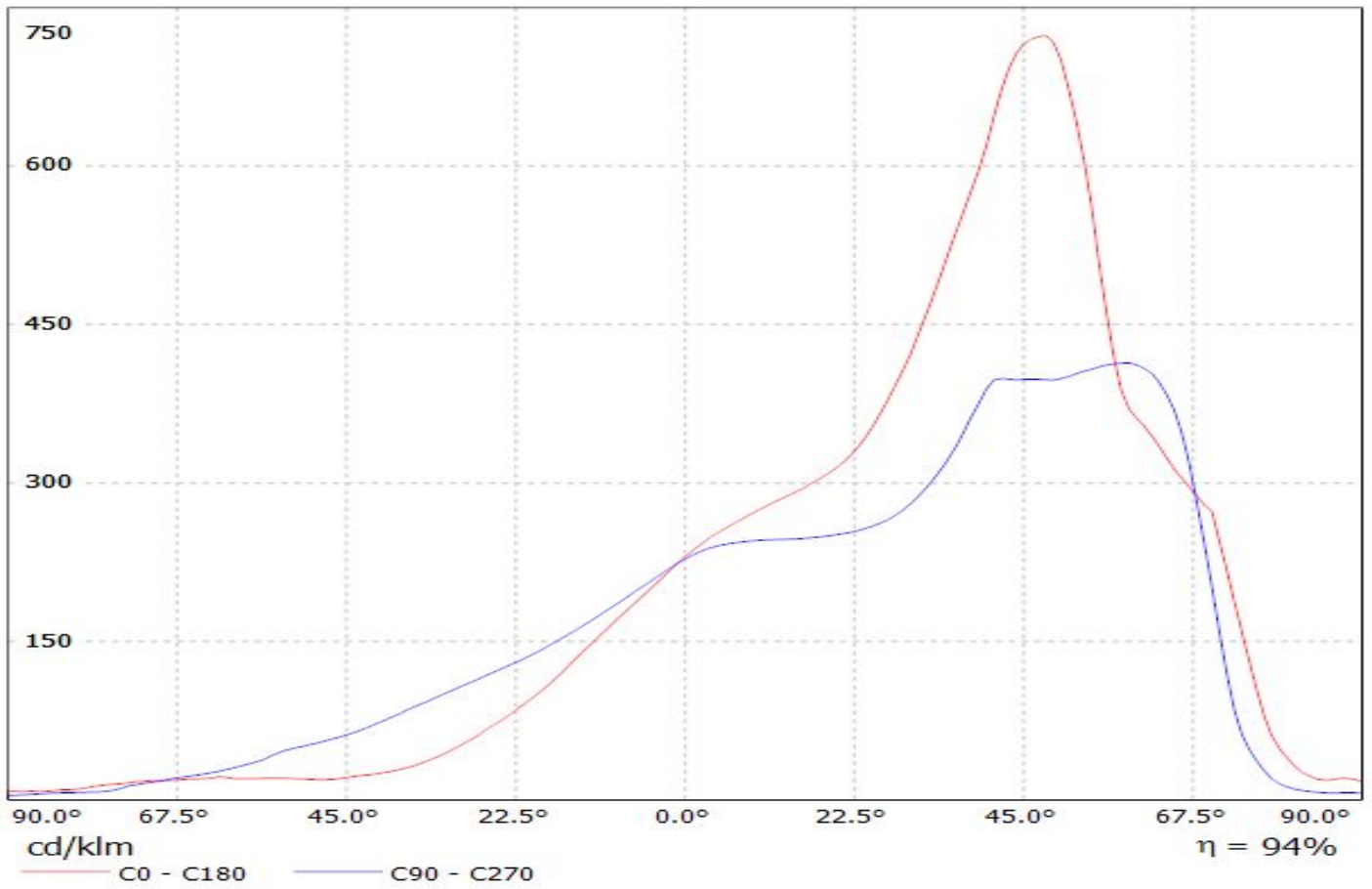

Luminaire: LEDiL Oy C14116_STRADA-2X2-PX_(NVSxx19B)
Lamps: 1 x NICHIA_NV5xx19B_(NVS219BE)
_2x2_315lm@250mA_CCT=3071K_U=2.88235W_I=249.9mA

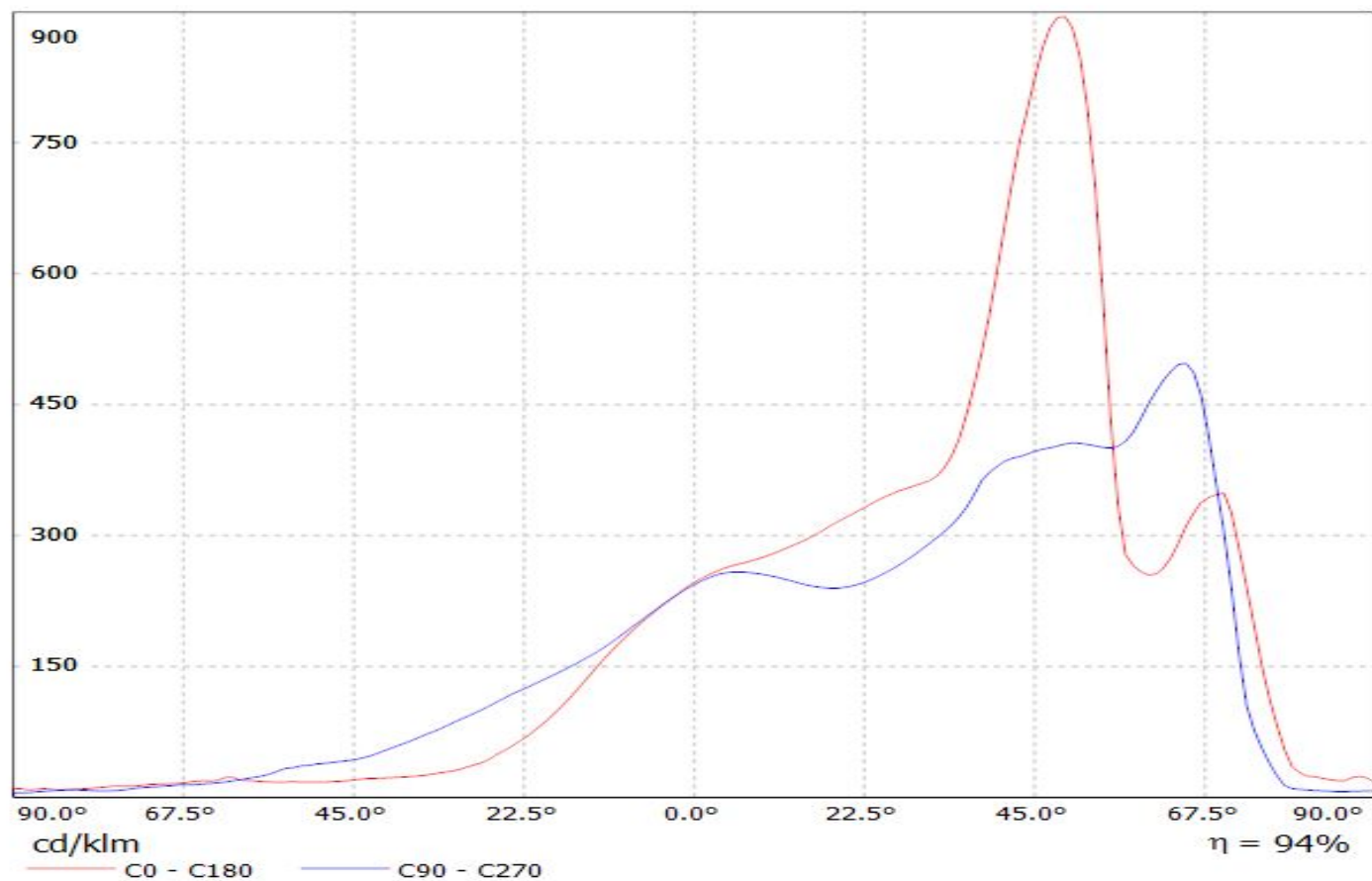

Ledil C14116_STRADA-2X2-PX_(TL1L4) / LDC (Linear)

Luminaire: Ledil C14116_STRADA-2X2-PX_(TL1L4)

Lamps: 1 x Toshiba_TL1L4_2x2_(TL1L4-DW0)_472.639lm@250mA_CCT=6500K_P=2.9W_I=0.25A

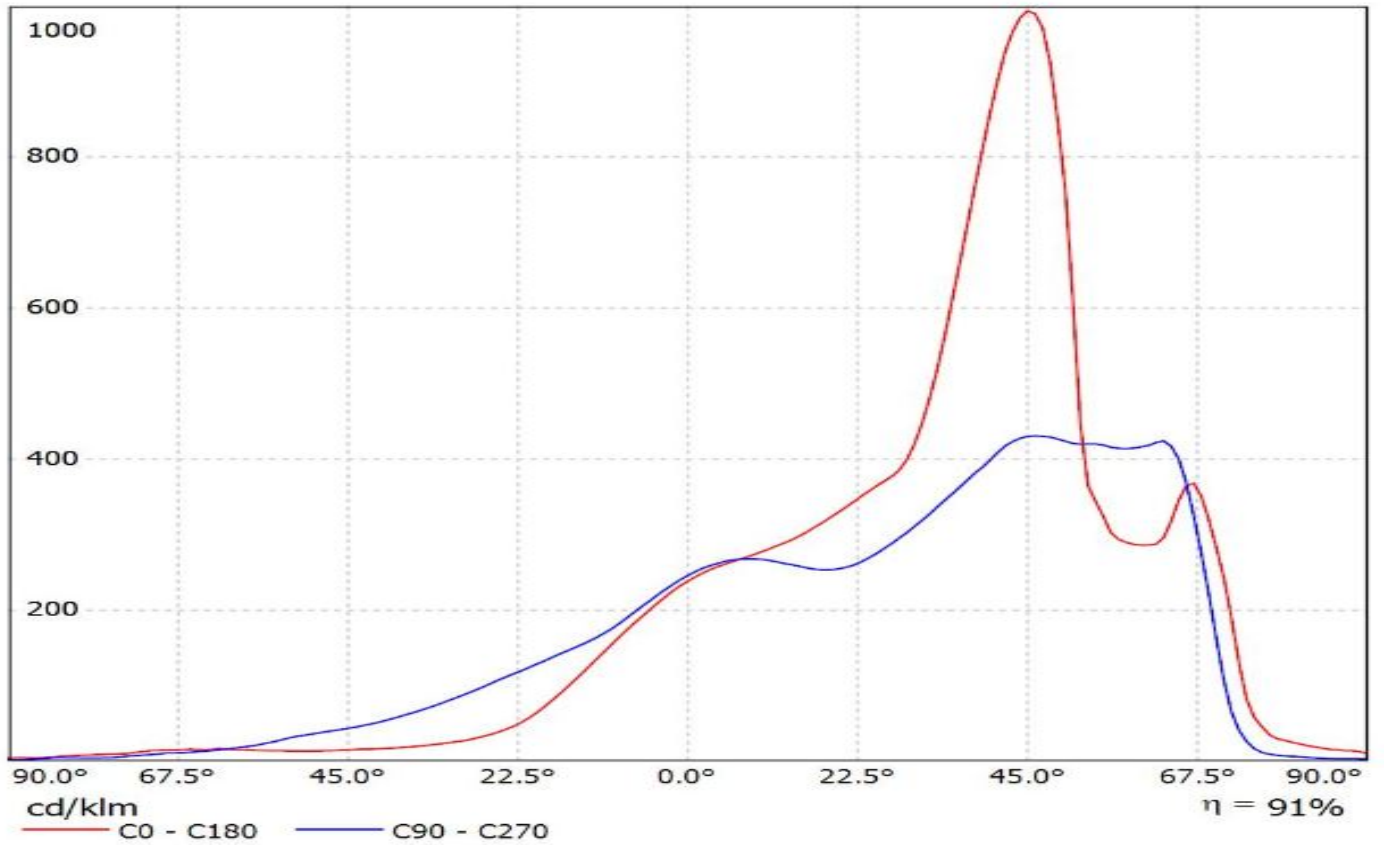

Luminaire: LEDiL Oy C14116_STRADA-2X2-PX_(Fortimo_F-Flex_2x8_740DAG3)
Lamps: 1 x Philips_Fortimo_F-Flex_2x8_740DAG3_1780.2lm@250mA_P=11.6112W_η=0.2498A

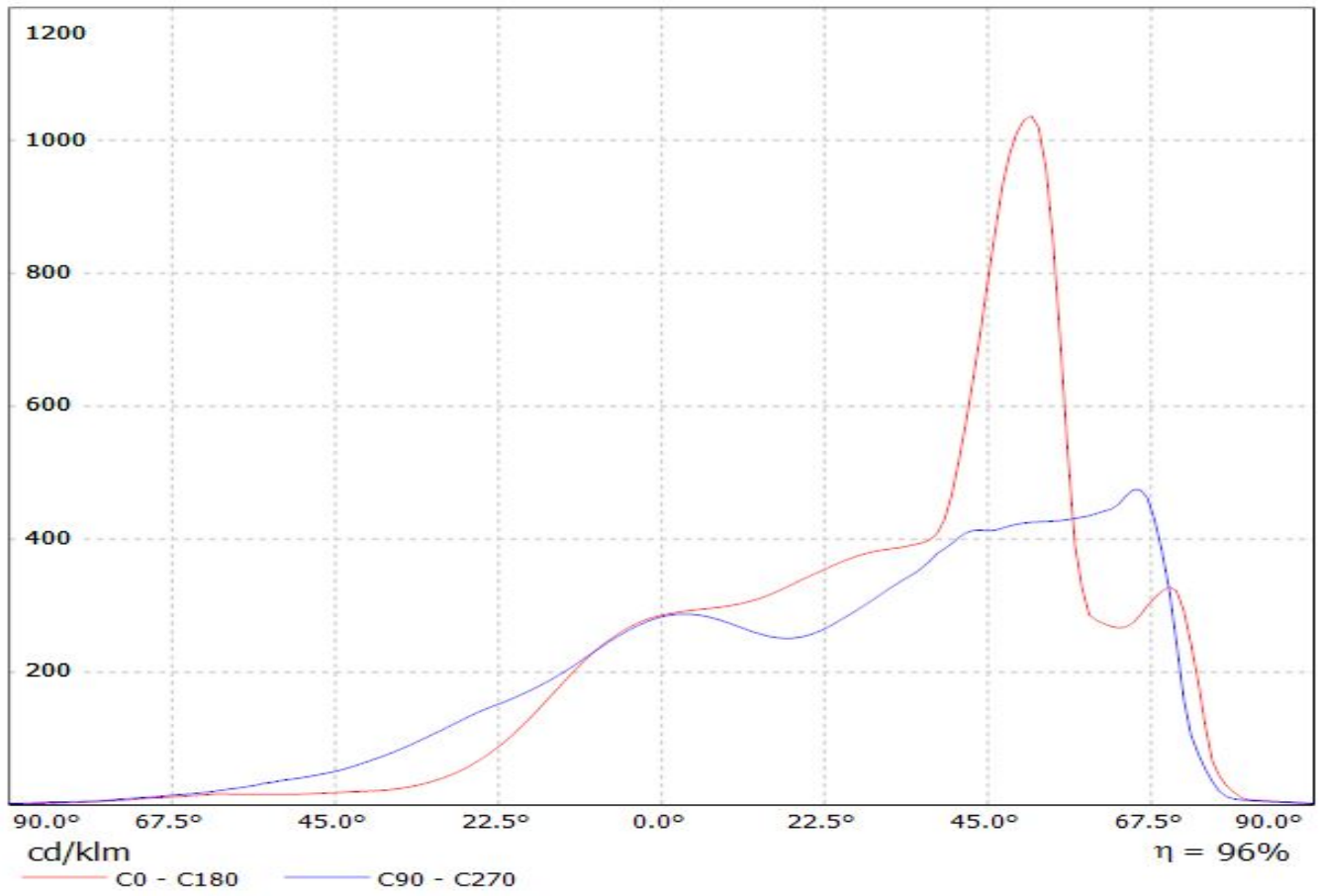

Luminaire: LEDiL Oy C14116_STRADA-2x2-PX_(Z5M1)
Lamps: 1 x SEOUL_Z5M1_2x2_(SZ5-M1-WN-C8)
_391.15lm@250mA_CCT=4587K_P=2.86086W_I=249.9mA

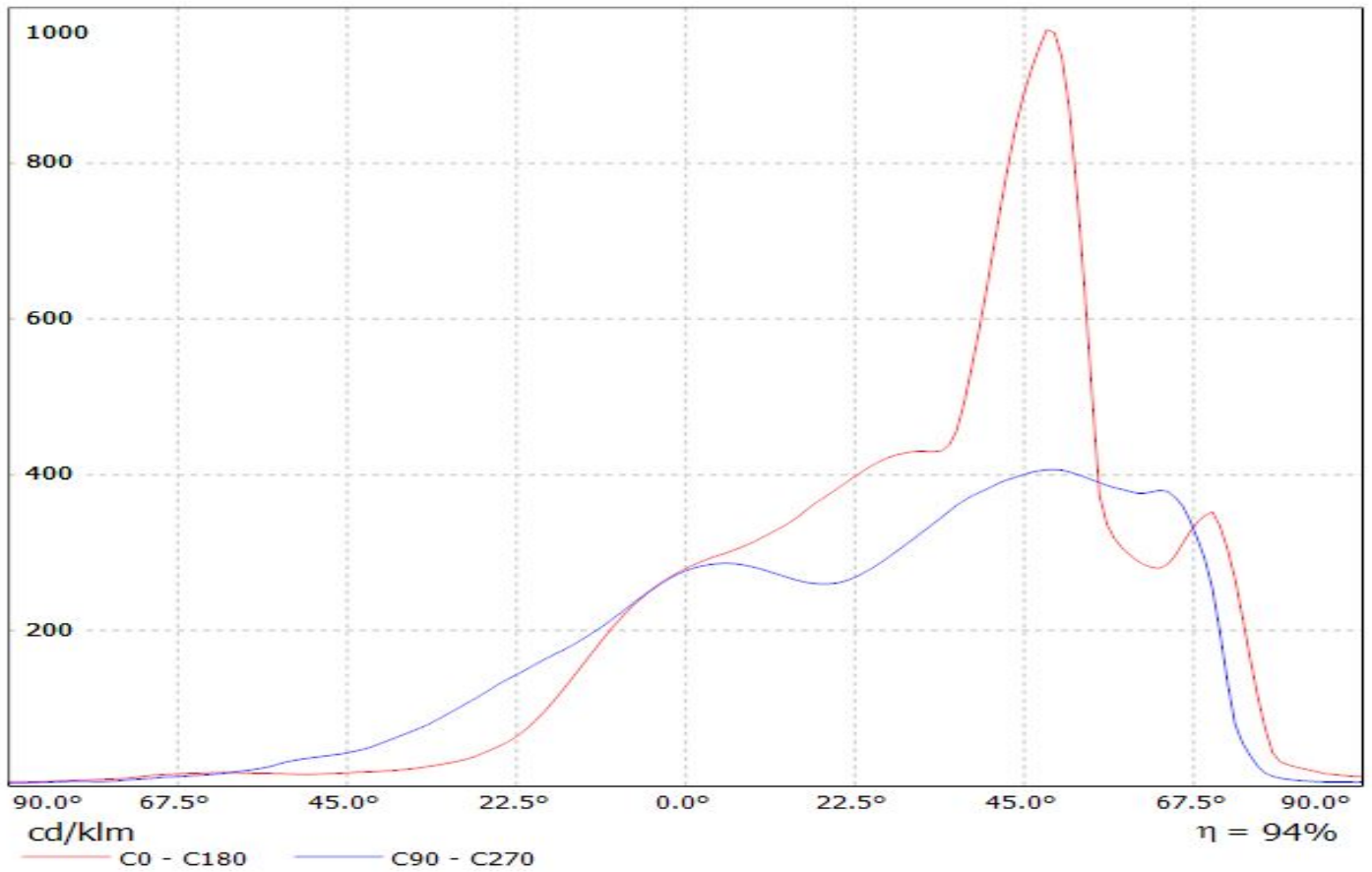

Luminaire: LEDiL Oy C14116_STRADA-2x2-PX_(Z5M)

Lamps: 1 x SEOUL_Z5M_2x2_(SZ5-M0-W0-00)_366.55lm@250mA_P=2.96931W_I=249.9mA

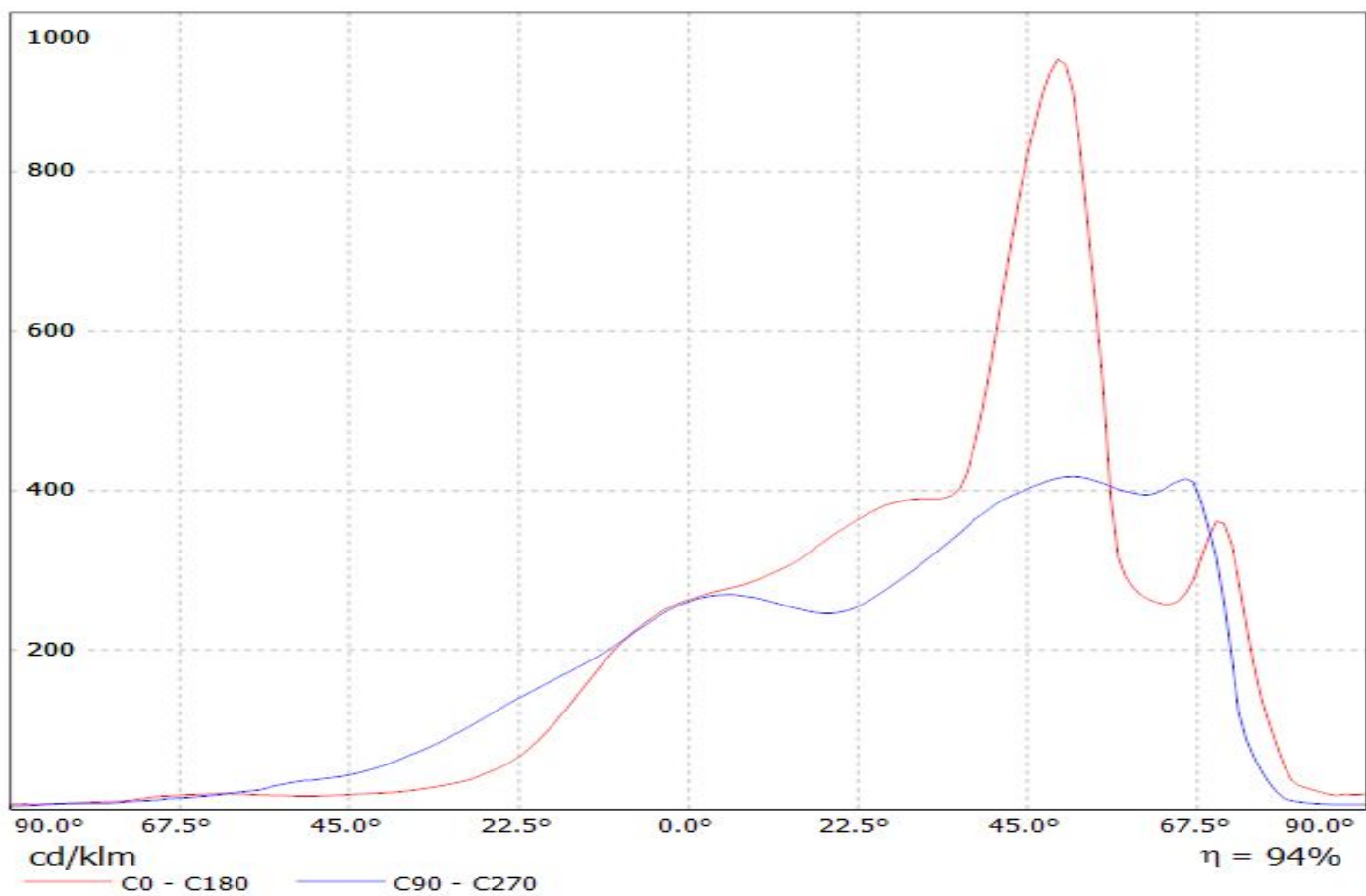

Luminaire: LEDiL Oy C14116_STRADA-2x2-PX_(LH351Z)

Lamps: 1 x SAMSUNG_LH351Z_2x2_(SZ5-M0-W0-00)_363.65lm@250mA_P=2.86635W_I=249.9mA

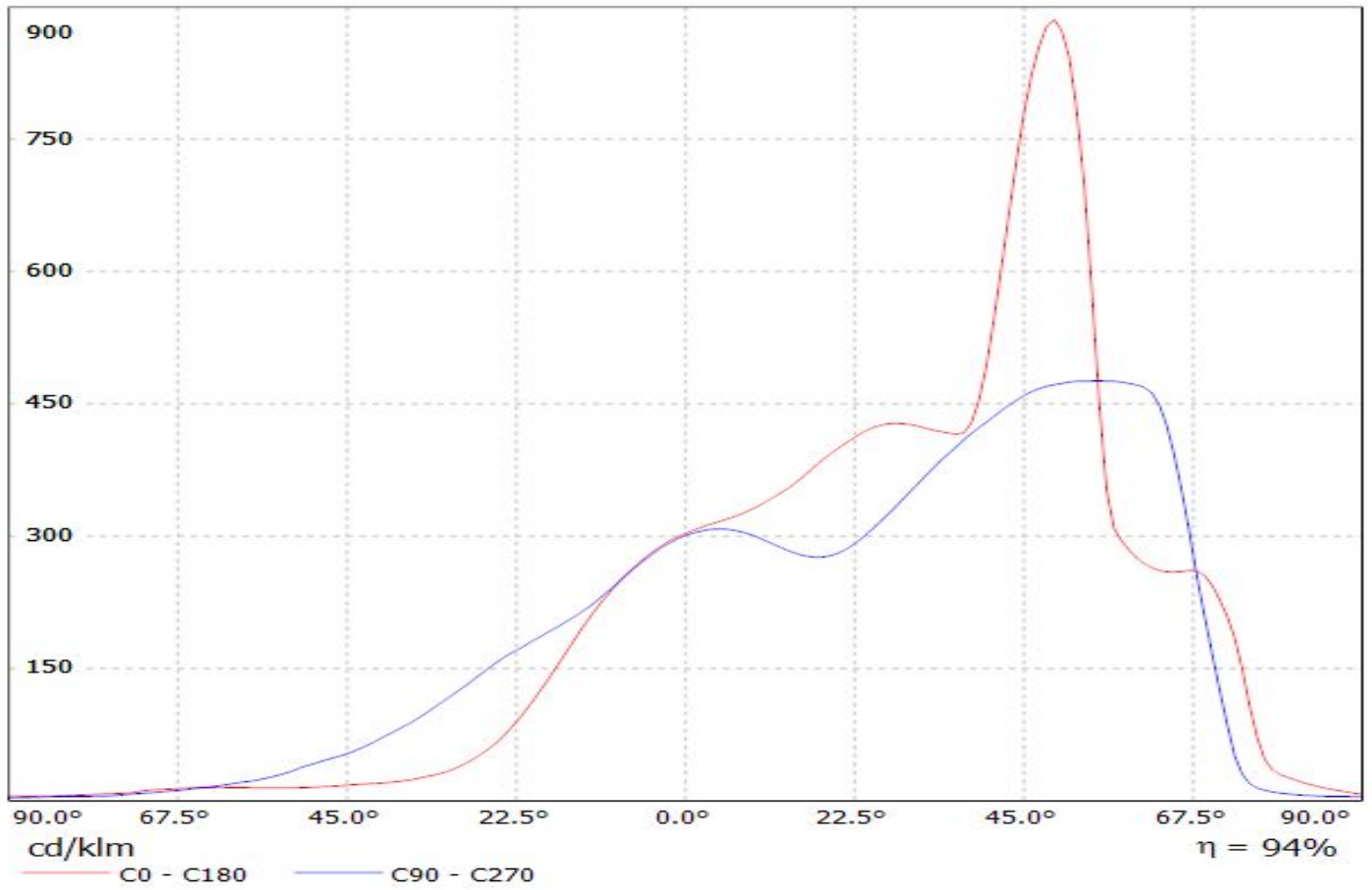

Luminaire: LEDiL Oy C14116_STRADA-2x2-PX (ACRICH_MJT_4040)
Lamps: 1 x SEOUL_ACRICH_MJT_4040_2x2_(SAW09H0A)
_131.93lm@250mA_P=1.12281W_I=19.5mA

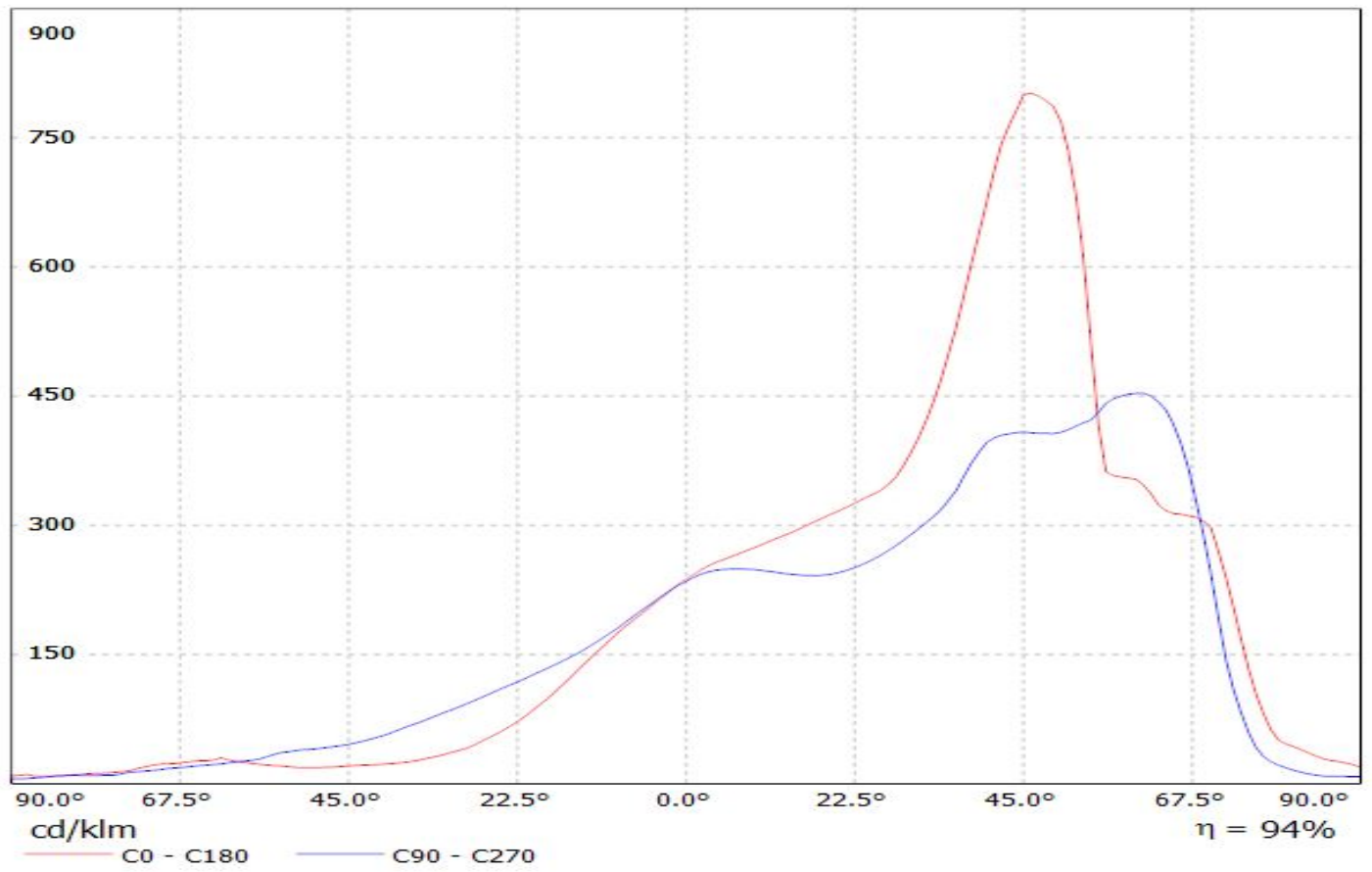

Luminaire: LEDiL Oy C14116_STRADA-2X2-PX_(XP-E2)

Lamps: 1 x CREE_XP-E2_2x2_(XPEBWT-L1-7B4-Q4-0-01)_340.5lm@250mA_P=2.93108W_I=249.9mA

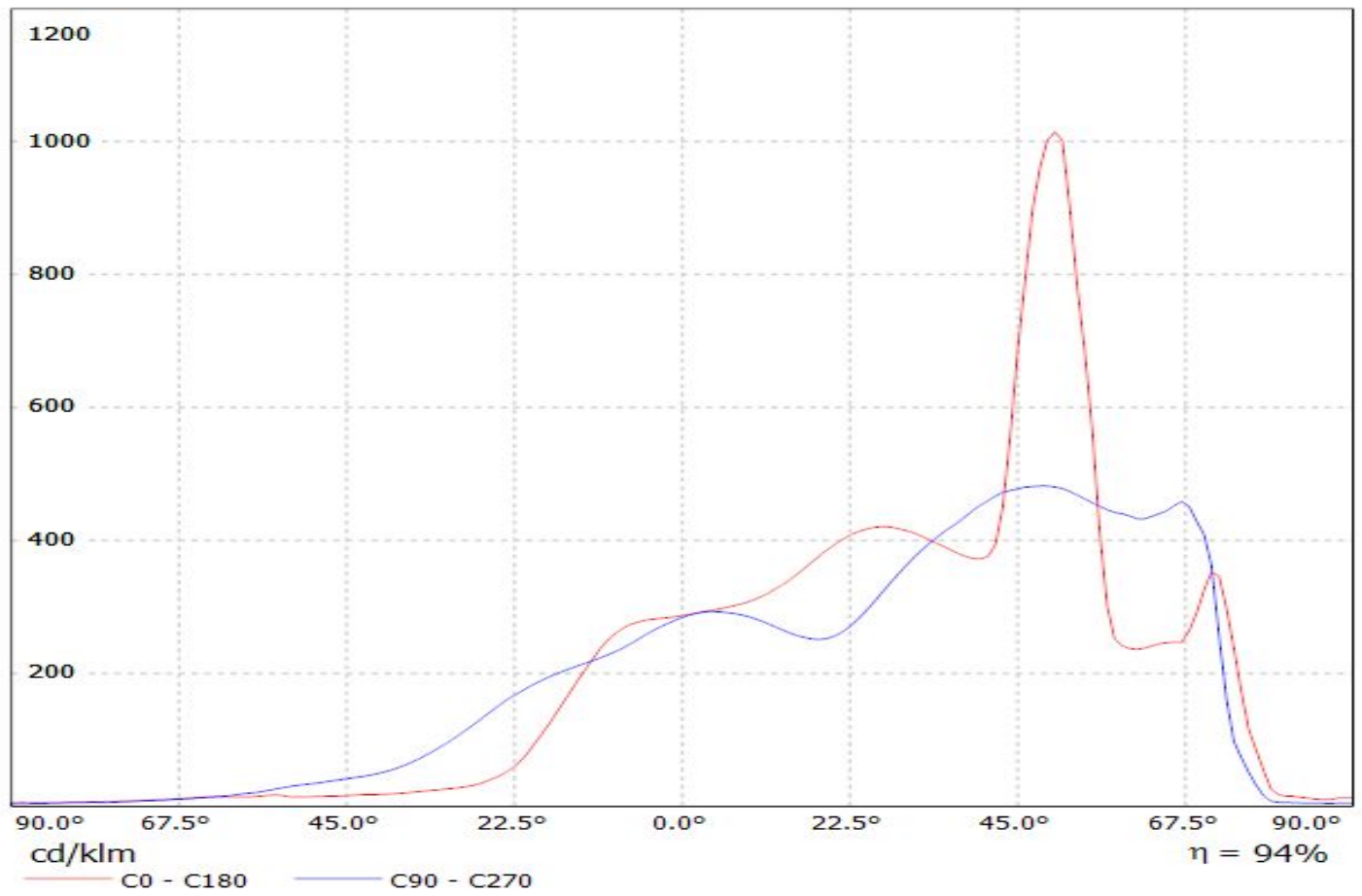

Luminaire: LEDiL Oy C14116_STRADA-2X2-PX_(XP-G)

Lamps: 1 x CREE_XP-G_2x2_259.15lm@250mA_P=2.90609W_I=249.9mA

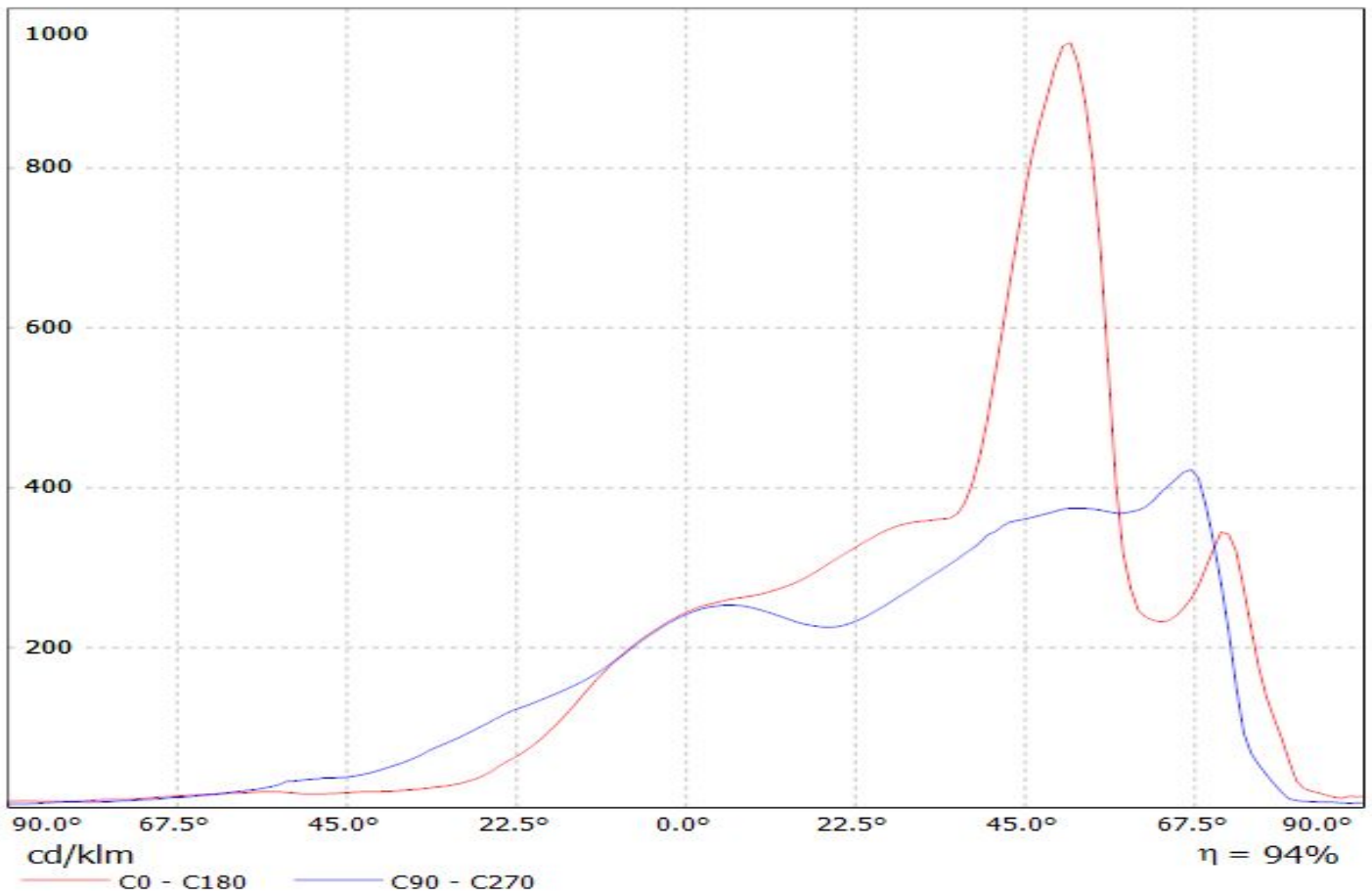

Luminaire: LEDiL Oy C14116_STRADA-2X2-PX_(XB-H)
Lamps: 1 x Cree_XB-H_2x2_(XBHAWT-0-5A3-T50-0L-0001)
_442.65lm@250mA_P=2.96762W_I=249.8mA

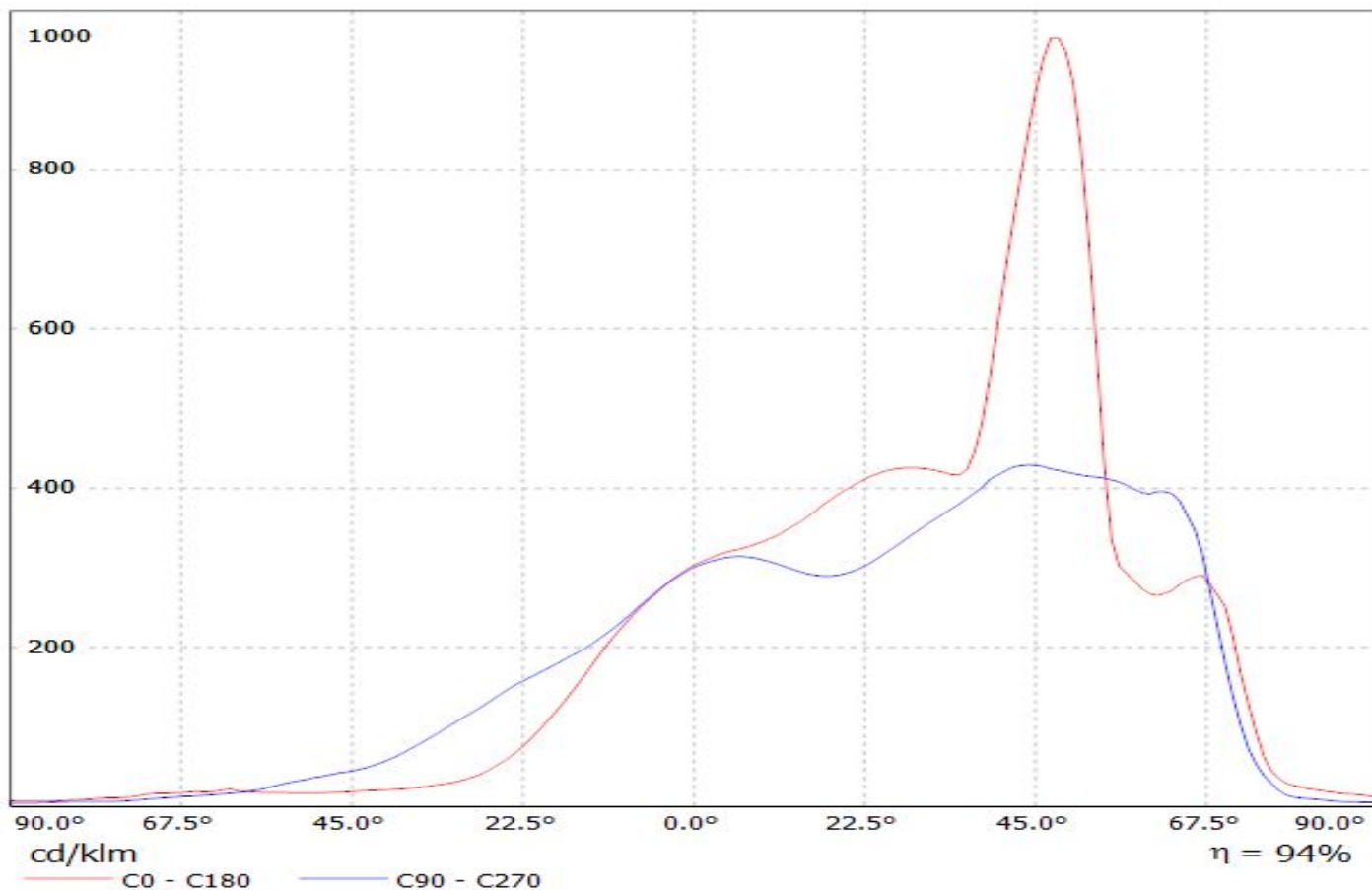

Luminaire: LEDiL Oy C14116_STRADA-2X2-PX_(XP-L)
Lamps: 1 x CREE_XP-L_2x2_(XPLAWT-0-1B0-V40-00-0001)
_508.5lm@250mA_CCT=7600K_P=2.80563W_I=249.9mA

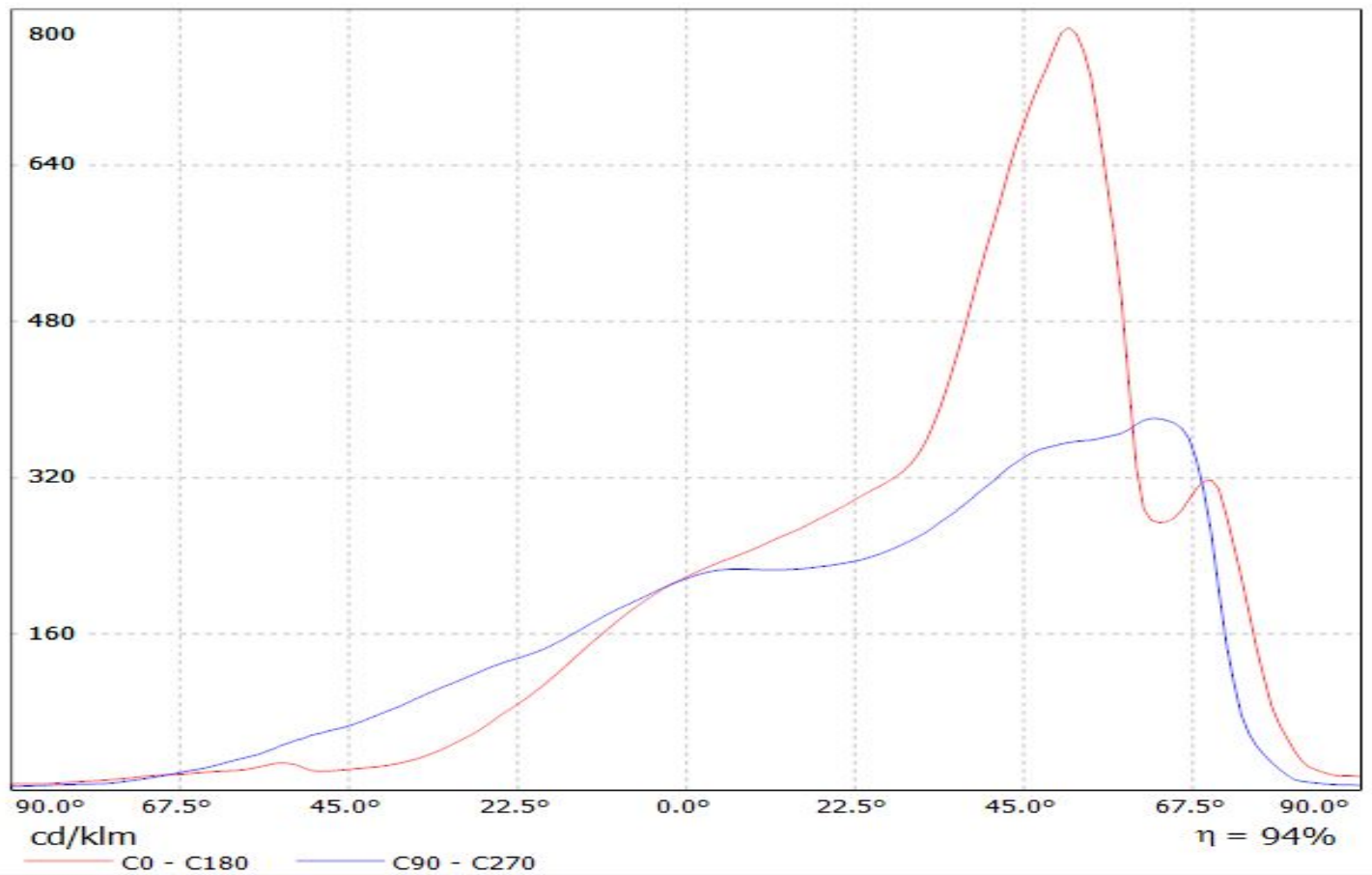

Luminaire: LEDiL Oy C14116_STRADA-2X2-PX_(LUXEON_R)
Lamps: 1 x LUXEON_R_2x2_(LXA7-PW30)_314.95lm@250mA_P=2.78414W_I=249.9mA

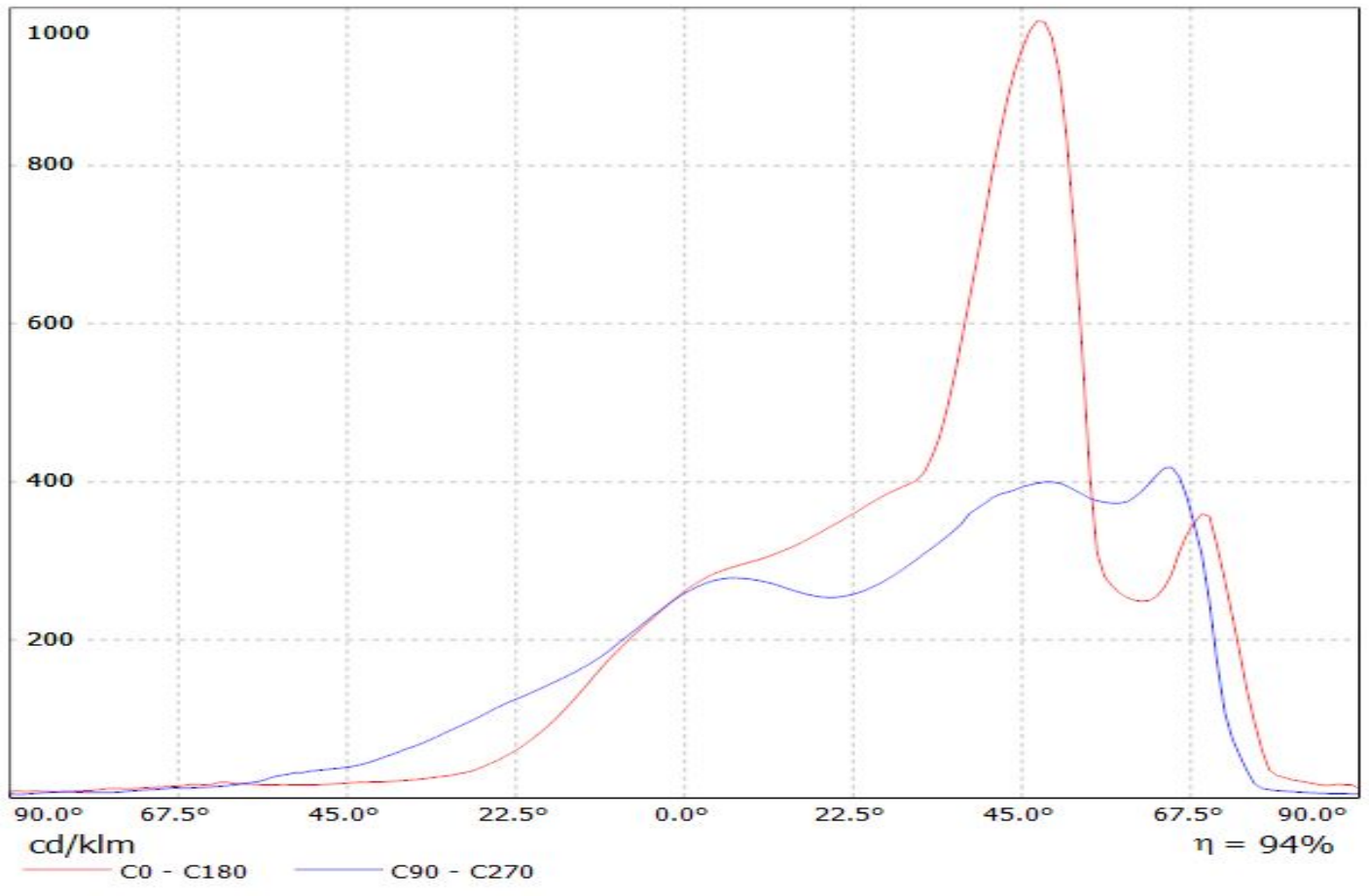

Luminaire: LEDiL Oy C14116_STRADA-2X2-PX (Z_ES)

Lamps: 1 x Luxeon_Z_ES_2x2_(LXZ2-3090)_214.14lm@250mA_P=2.82437W_I=249.9mA

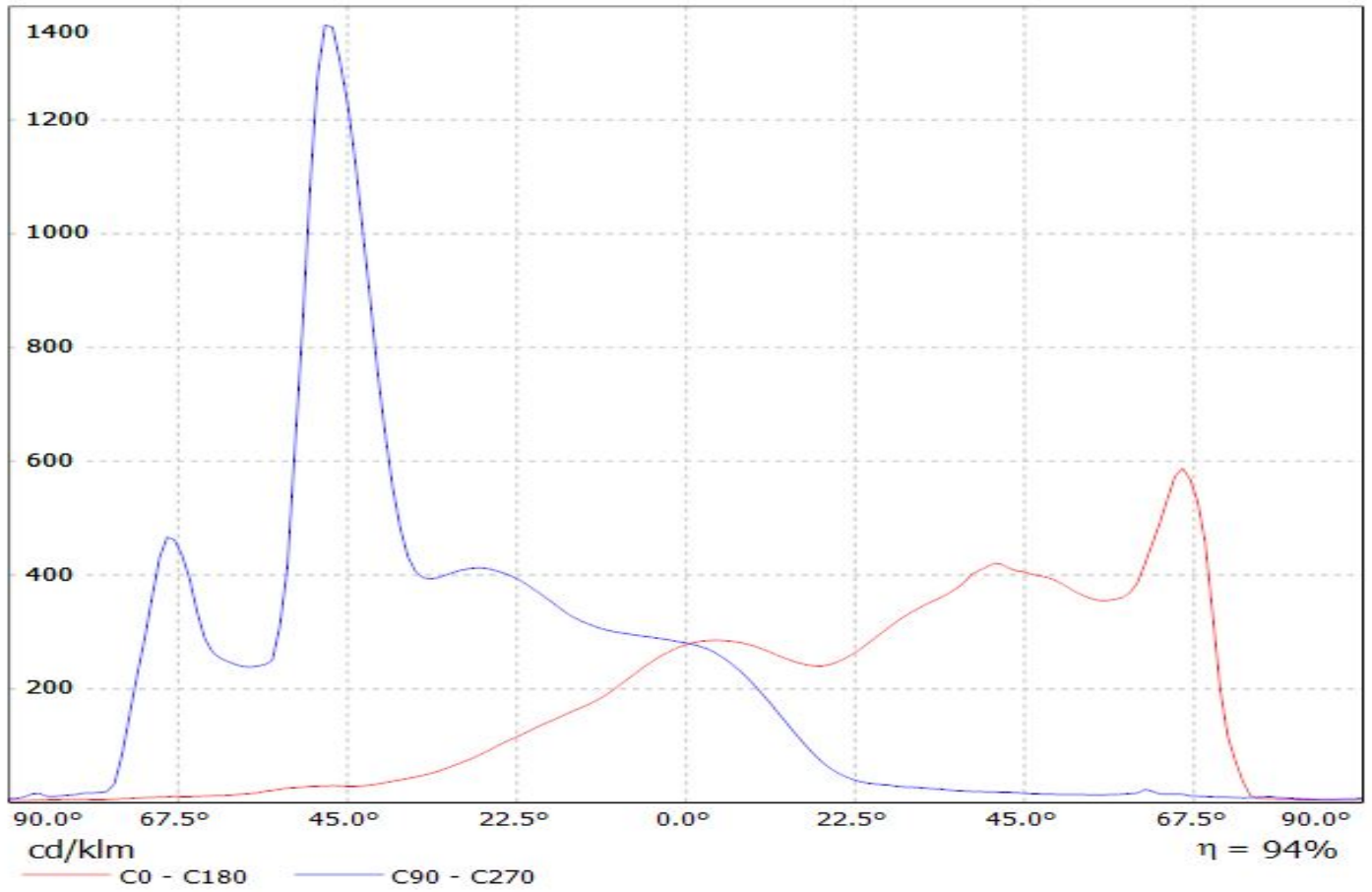

Luminaire: LEDiL Oy C14116_STRADA-2X2-PX_(NCSxx19A)
Lamps: 1 x Nichia_NCSxx19A_(NCS119AT-H1)
_234.37lm@250mA_CCT=2830K_P=3.07452W_I=249.9mA

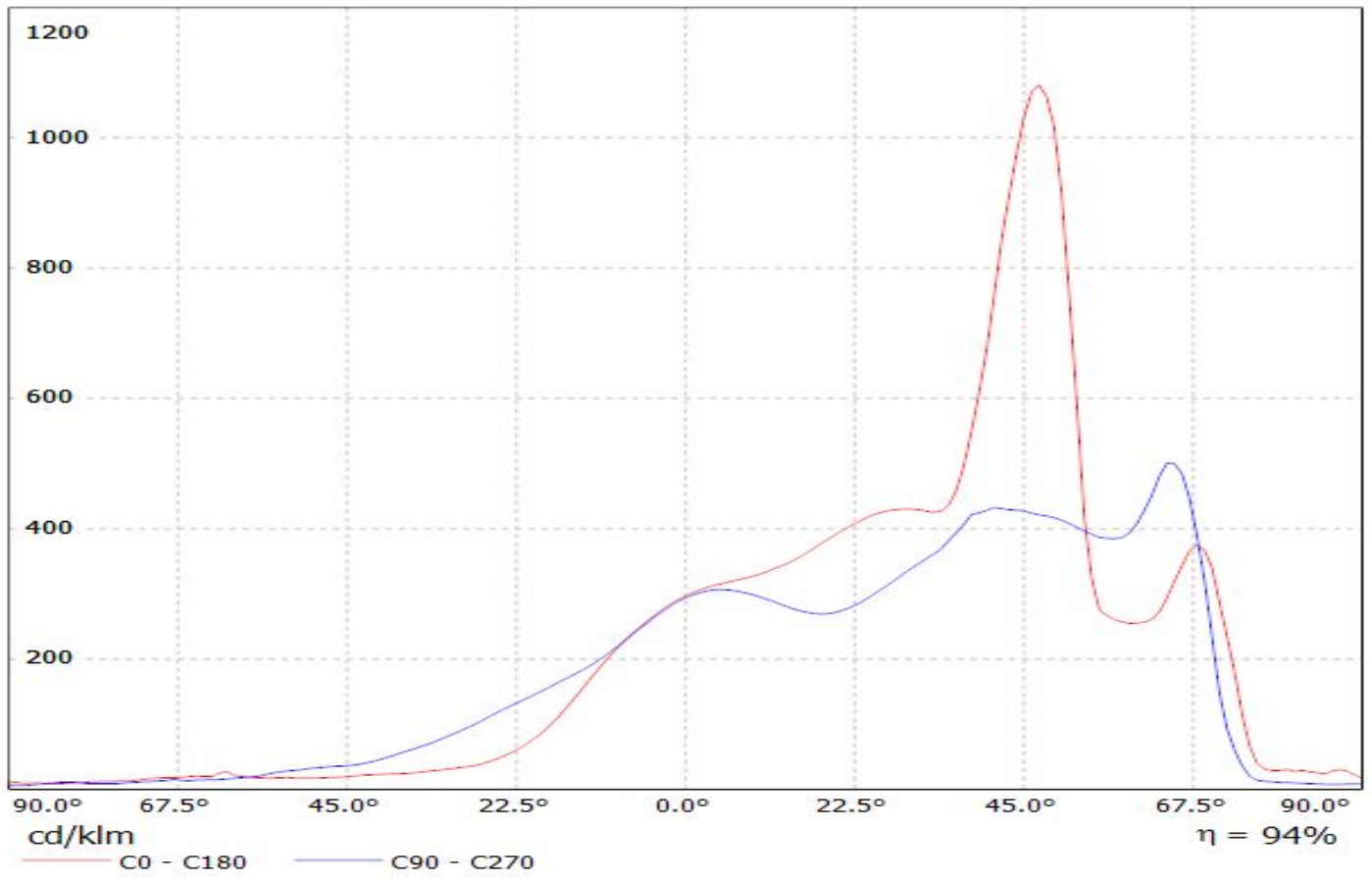

Luminaire: LEDiL Oy C14116_STRADA-2X2-PX_(NVSxx19A)

Lamps: 1 x Nichia_NVsxx19A_(NVS219AT)_392.14lm@250mA_P=2.91991W_I=249.8mA

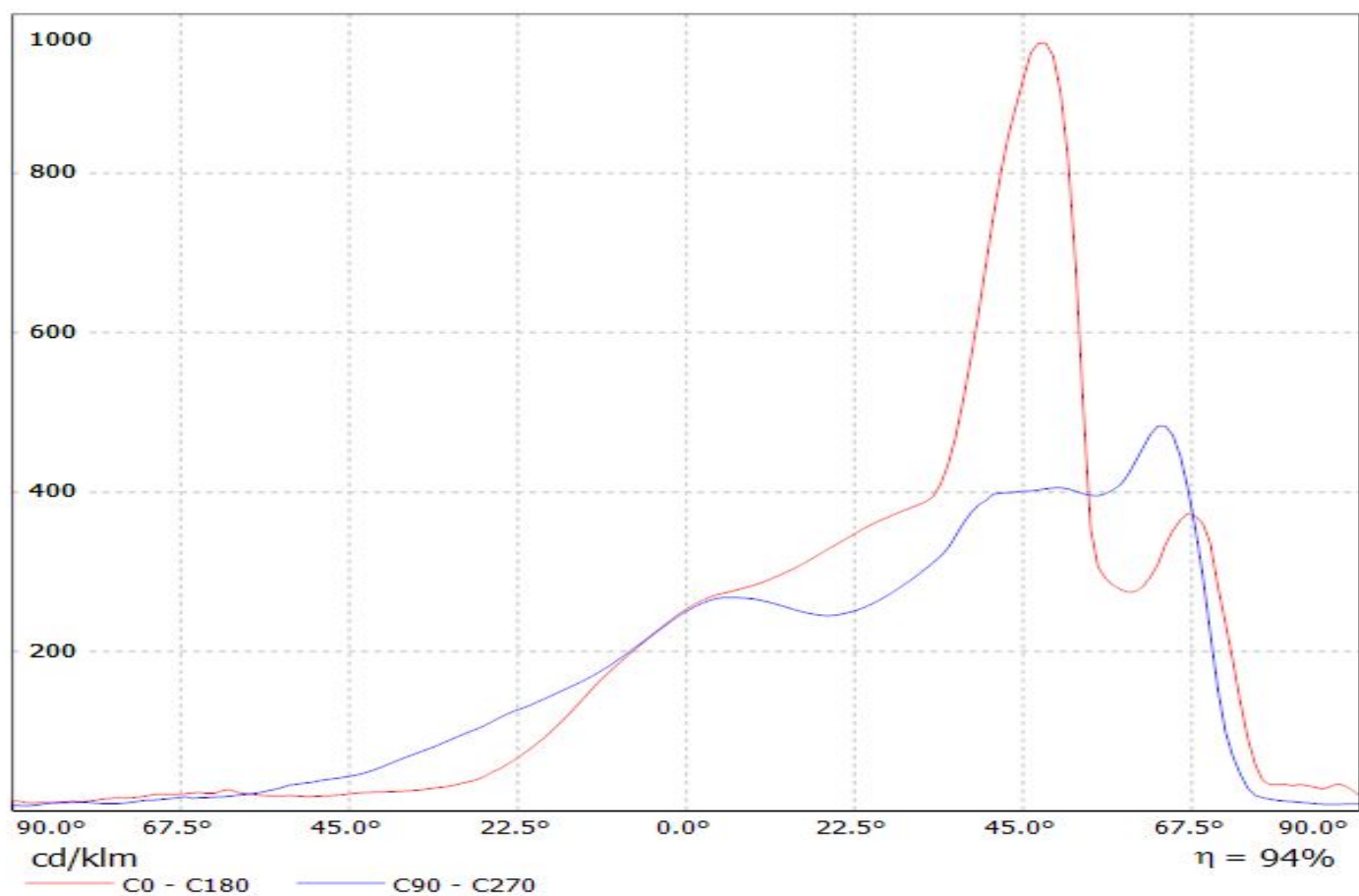

Luminaire: LEDiL Oy C14116_STRADA-2X2-PX_(LUXEON_Q)

Lamps: 1 x LUXEON_Q_2x2_(LHQ-3080)_306.14lm@250mA_P=2.88419W_I=249.8mA

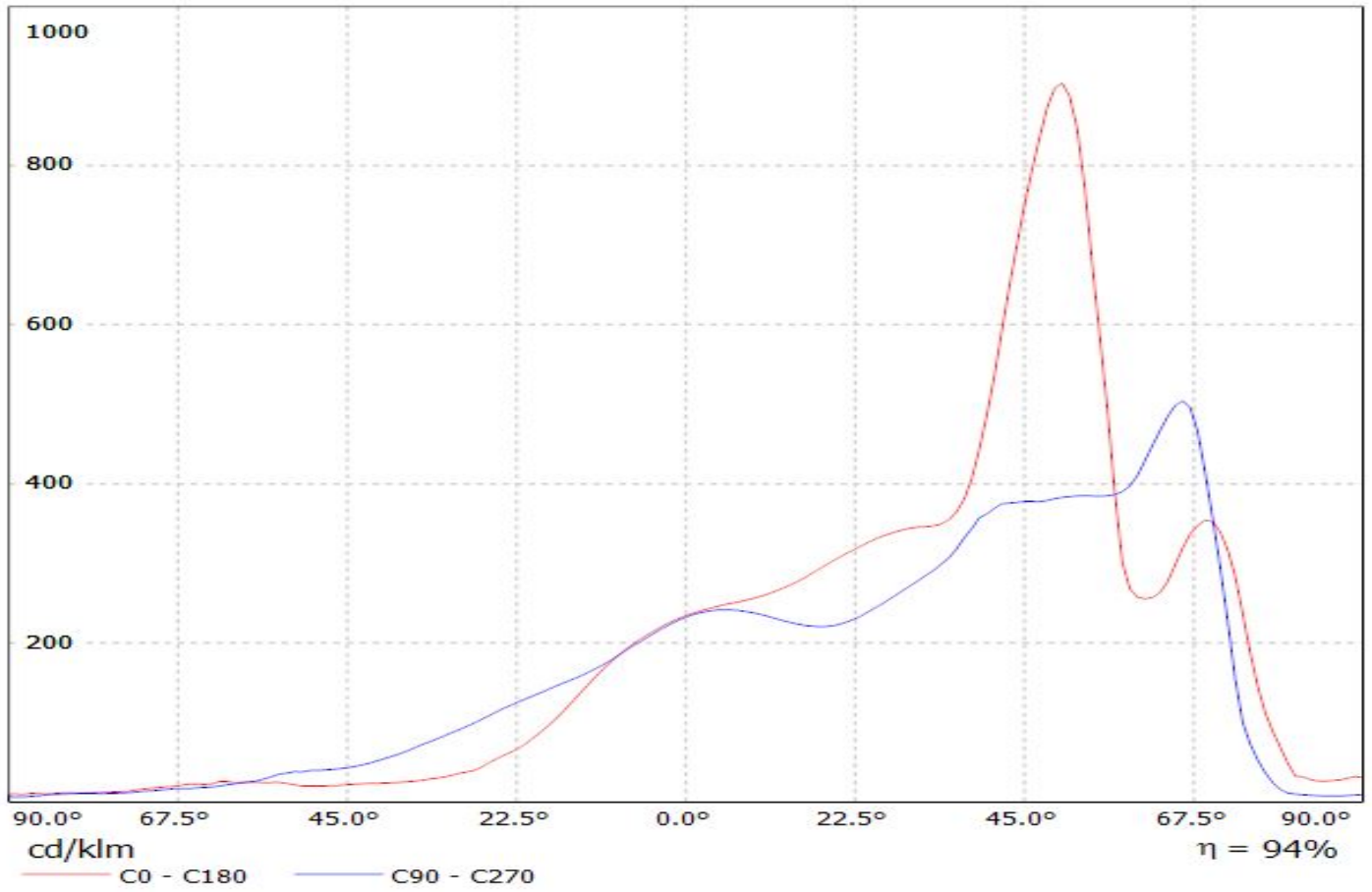

Luminaire: LEDiL Oy C14116_STRADA-2X2-PX_(LUXEON_TX)

Lamps: 1 x LUXEON_TX_2x2_(L1T2-3585)_327.05lm@250mA_P=2.79476W_I=249.8mA

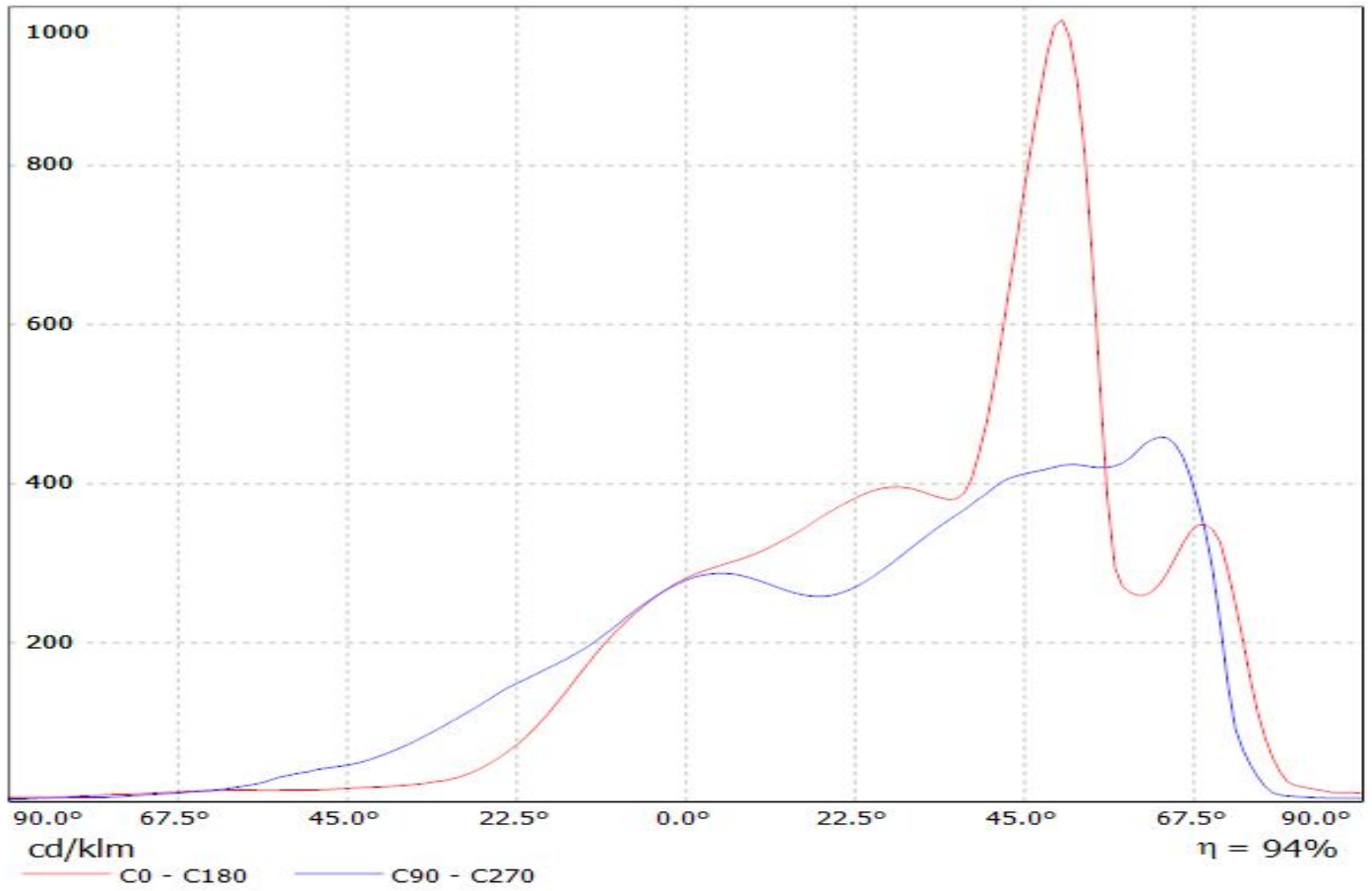

Ledil C14116_STRADA-2X2-PX_(TL1L3) / LDC (Polar)

Luminaire: Ledil C14116_STRADA-2X2-PX_(TL1L3)

Lamps: 1 x Toshiba_TL1L3_2x2_(TL1L3-NW1.L)_387.773lm@250mA_CCT=5000K_P=2.829W_I=0.25A

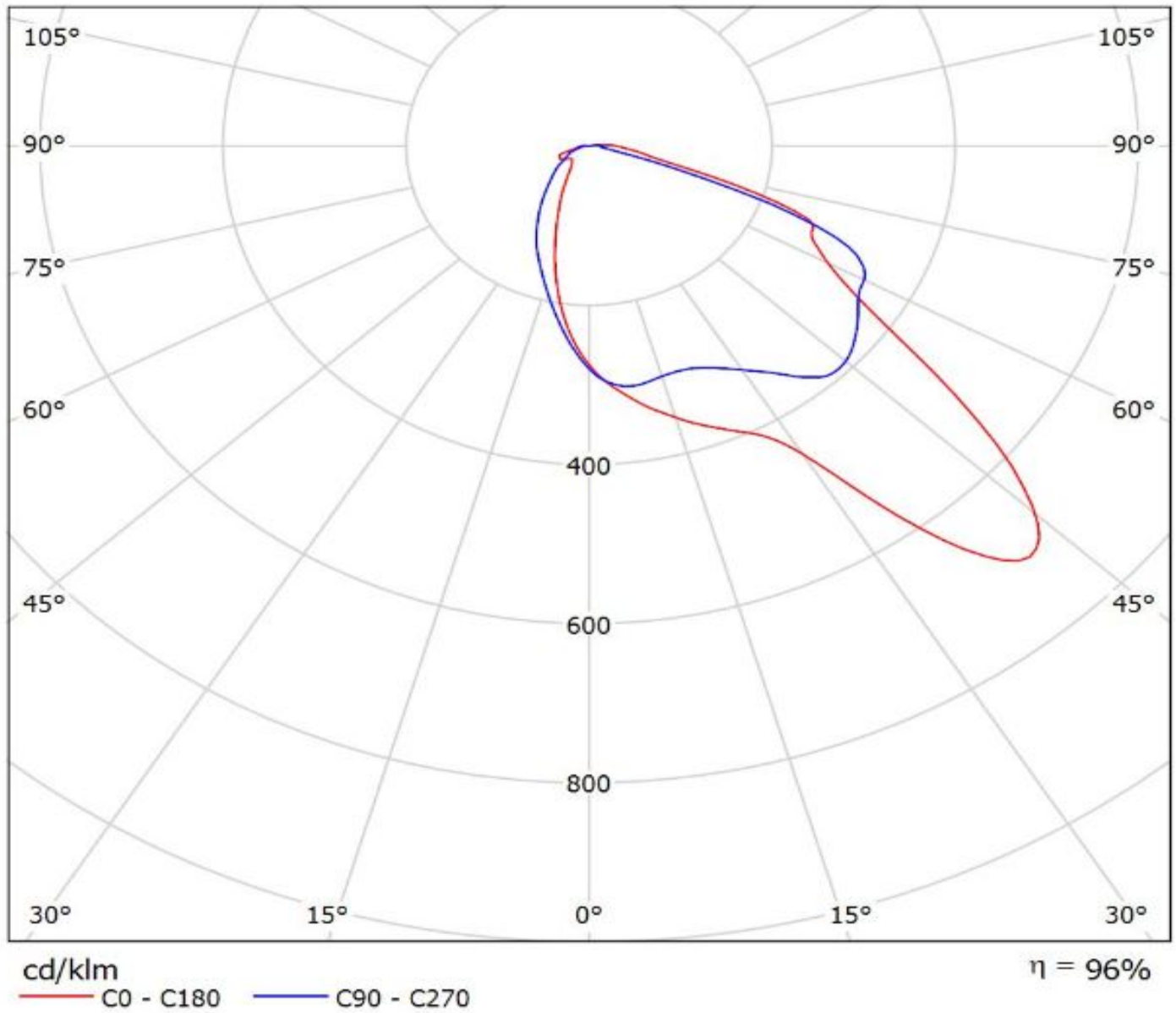

Luminaire: LEDiL Oy C14116_STRADA-2X2-PX_(XT-E)

Lamps: 1 x CREE_XT-E_2x2_390.75lm@250mA_CCT=5717K_P=2.99855W_I=249.9mA

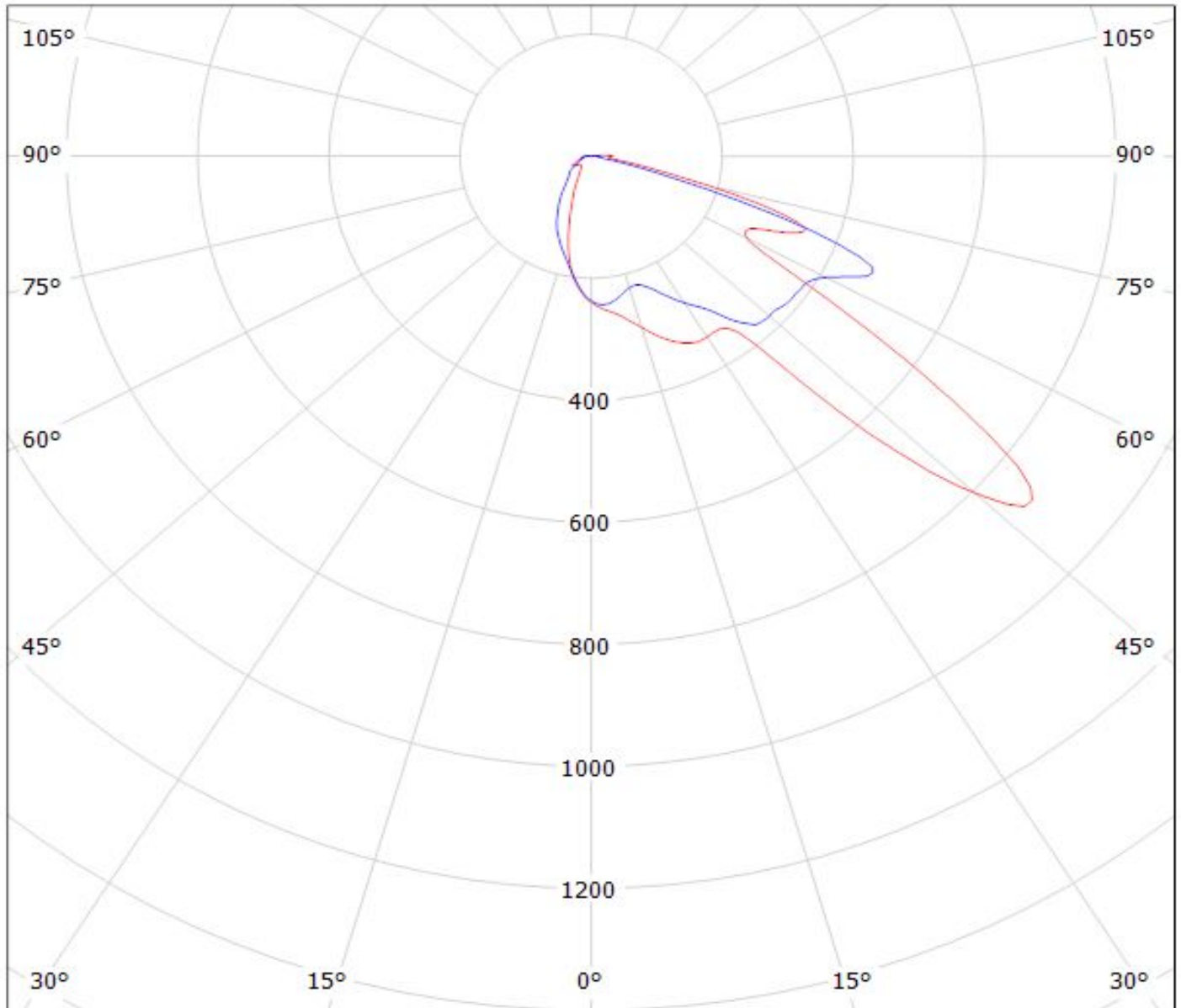

cd/klm

— C0 - C180

— C90 - C270

$\eta = 94\%$

Luminaire: LEDiL Oy C14116_STRADA-2X2-PX_(XM-L2)
Lamps: 1 x CREE_XM-L2_2x2_(XMLBWT-0-7B4-T30-0L-001)
_361.65lm@250mA_CCT3220K_P=2.81924W_I=249.8mA

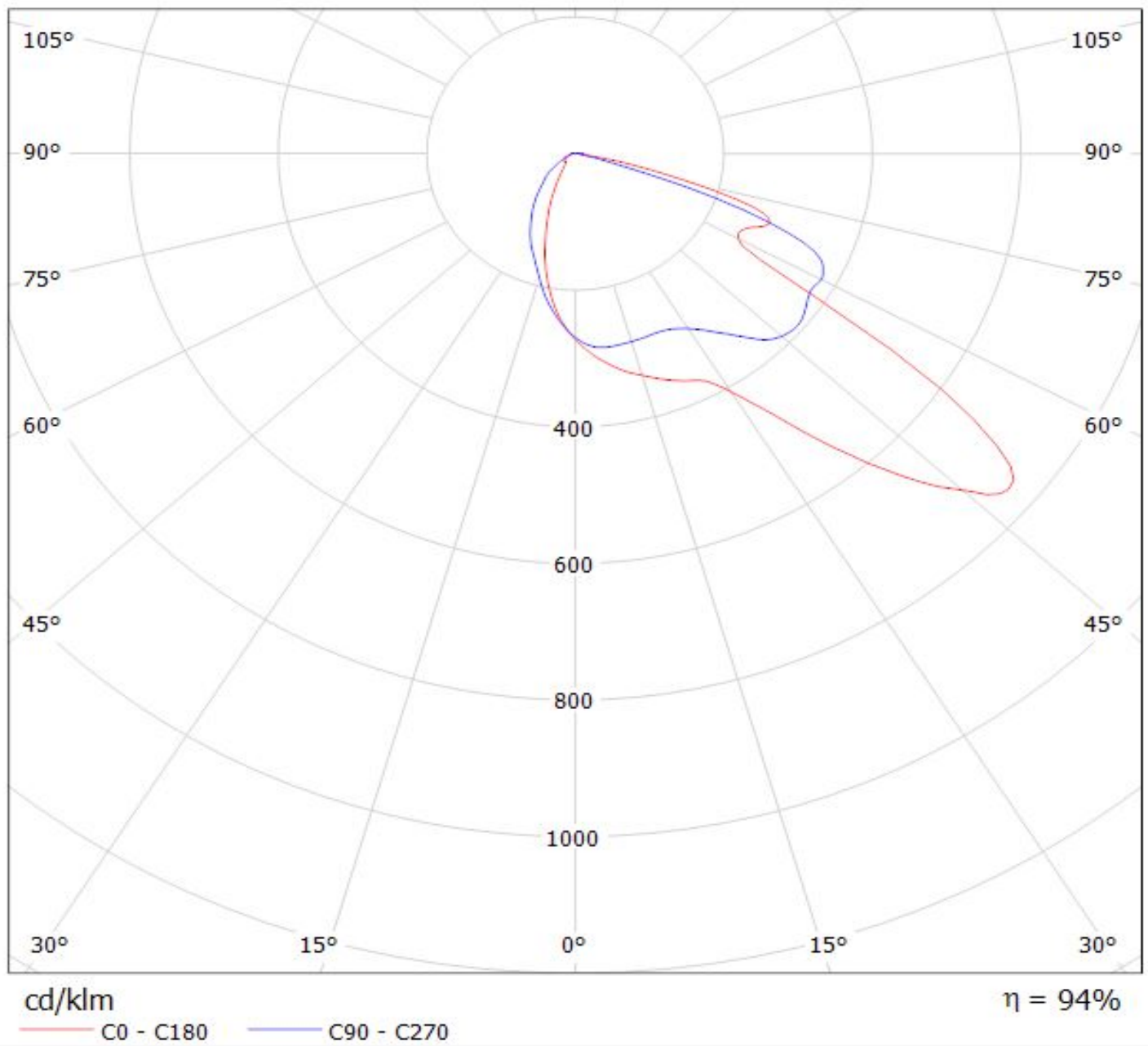

Luminaire: LEDiL Oy C14116_STRADA-2X2-PX_(XM-L)

Lamps: 1 x CREE_XM-L_2x2_362.5lm@250mA_CCT7700K_P=2.83911W_I=249.9mA

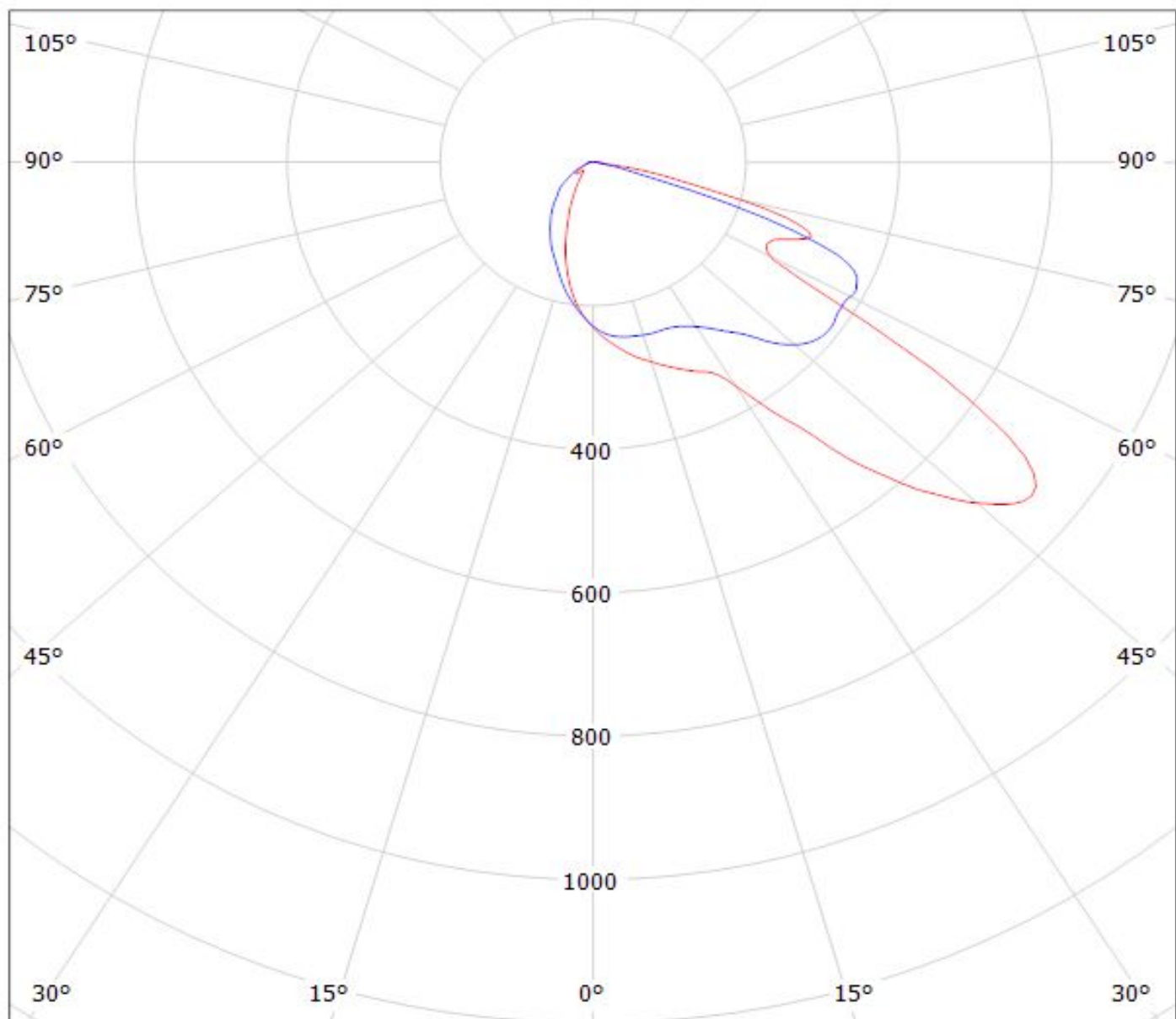

cd/klm

— C0 - C180

— C90 - C270

$\eta = 94\%$

Luminaire: LEDiL Oy C14116_STRADA-2X2-PX_(XP-G2)
Lamps: 1 x CREE_XP-G2_2x2_(XPGBWT-L1-000-00G51)
_414.85lm@250mA_CCT=7181K_P=2.95563W_I=249.8mA

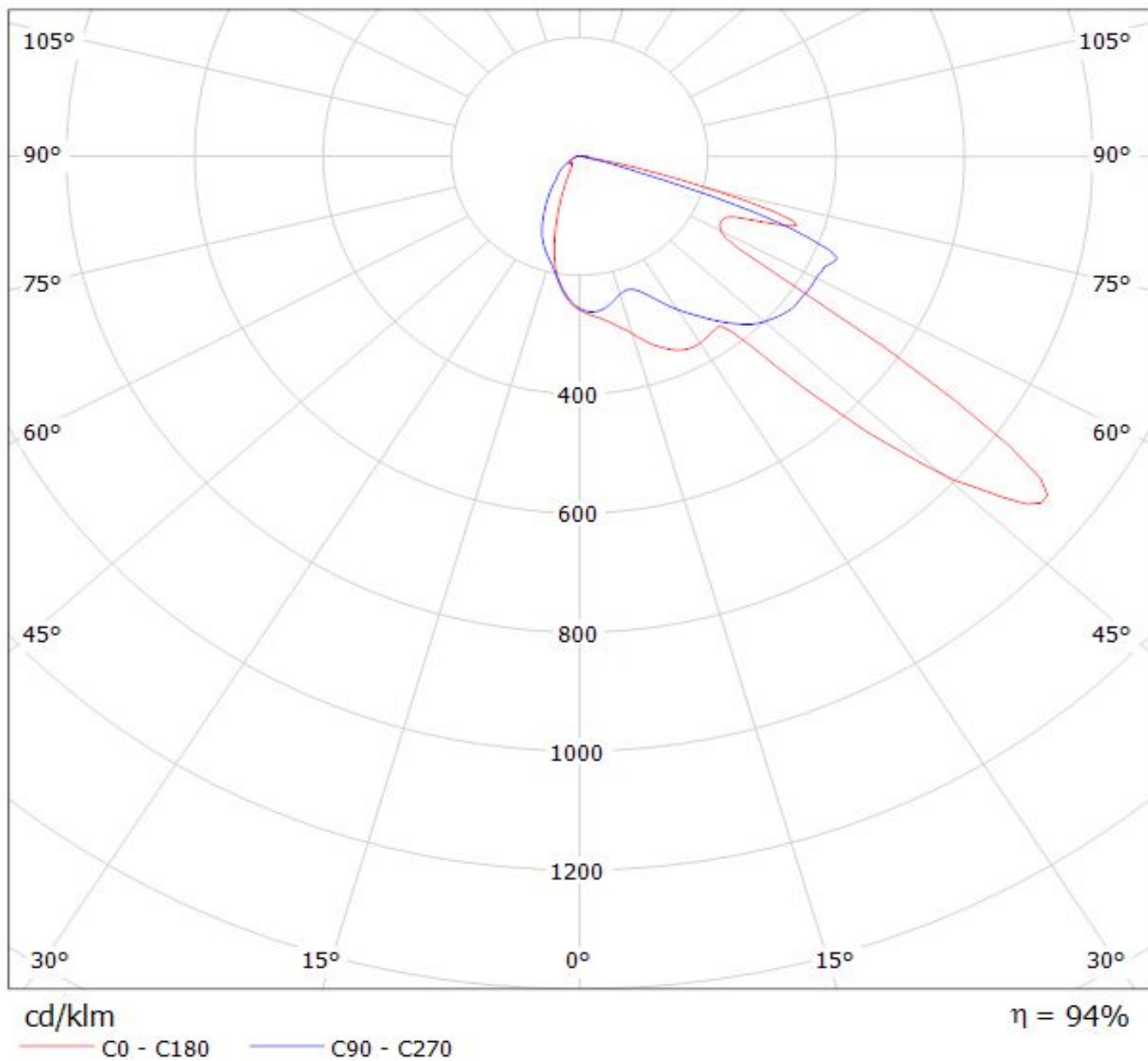

Luminaire: LEDiL Oy C14116_STRADA-2x2-PX_(Z5P)

Lamps: 1 x SEOUL_Z5P_2x2_286.1lm@250mA_P=3.66253W_I=249.9mA

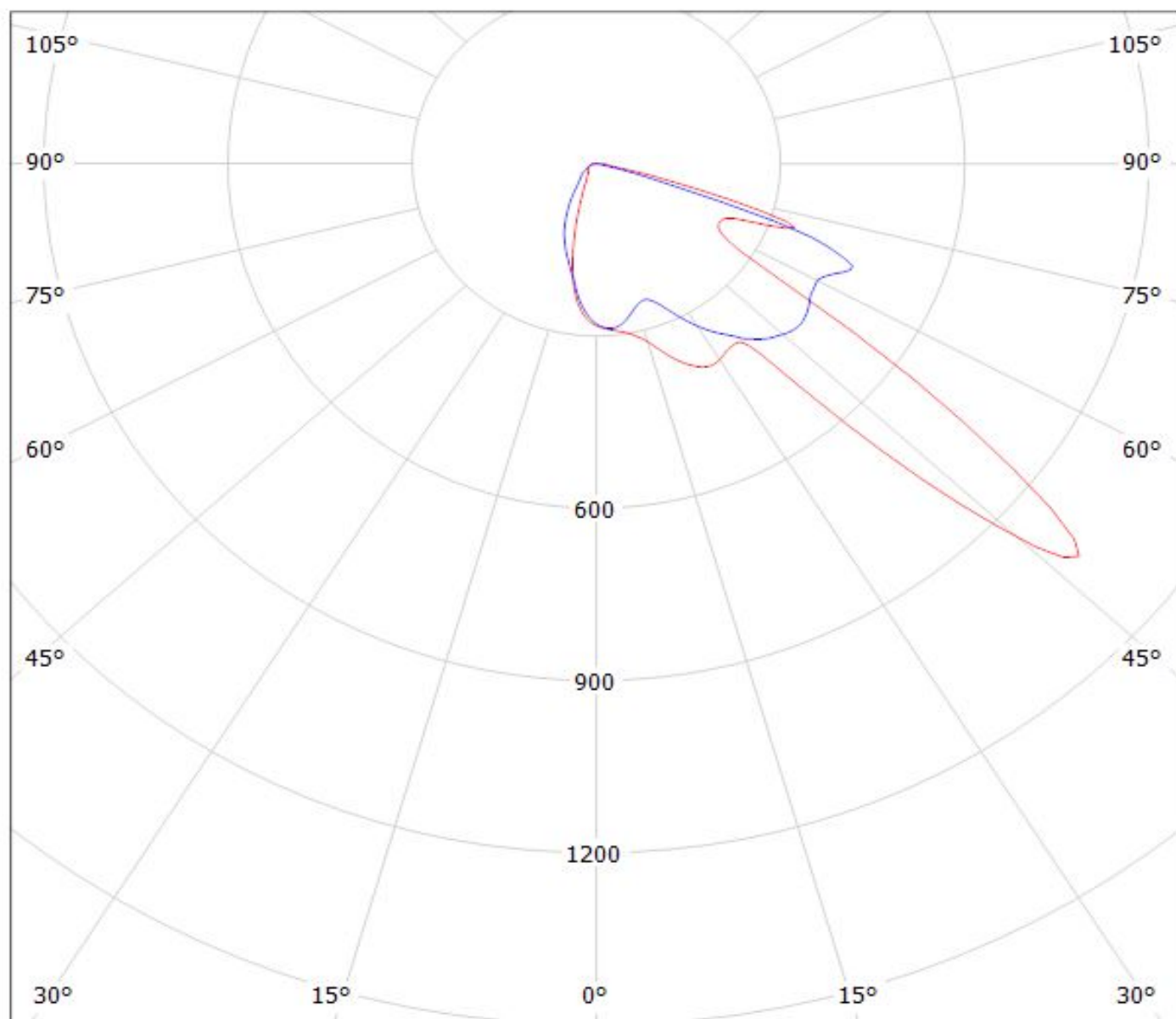

cd/klm

— C0 - C180

— C90 - C270

$\eta = 94\%$

Luminaire: LEDiL Oy C14116_STRADA-2X2-PX_(SQ-PC)

Lamps: 1 x OSRAM OSOLON SQUARE_PC_2x2_(LCW_CQAR.PC-MSMU-5H71-1)

_423.6lm@250mA_CCT=5960K_P=2.86246W_I=249.8mA

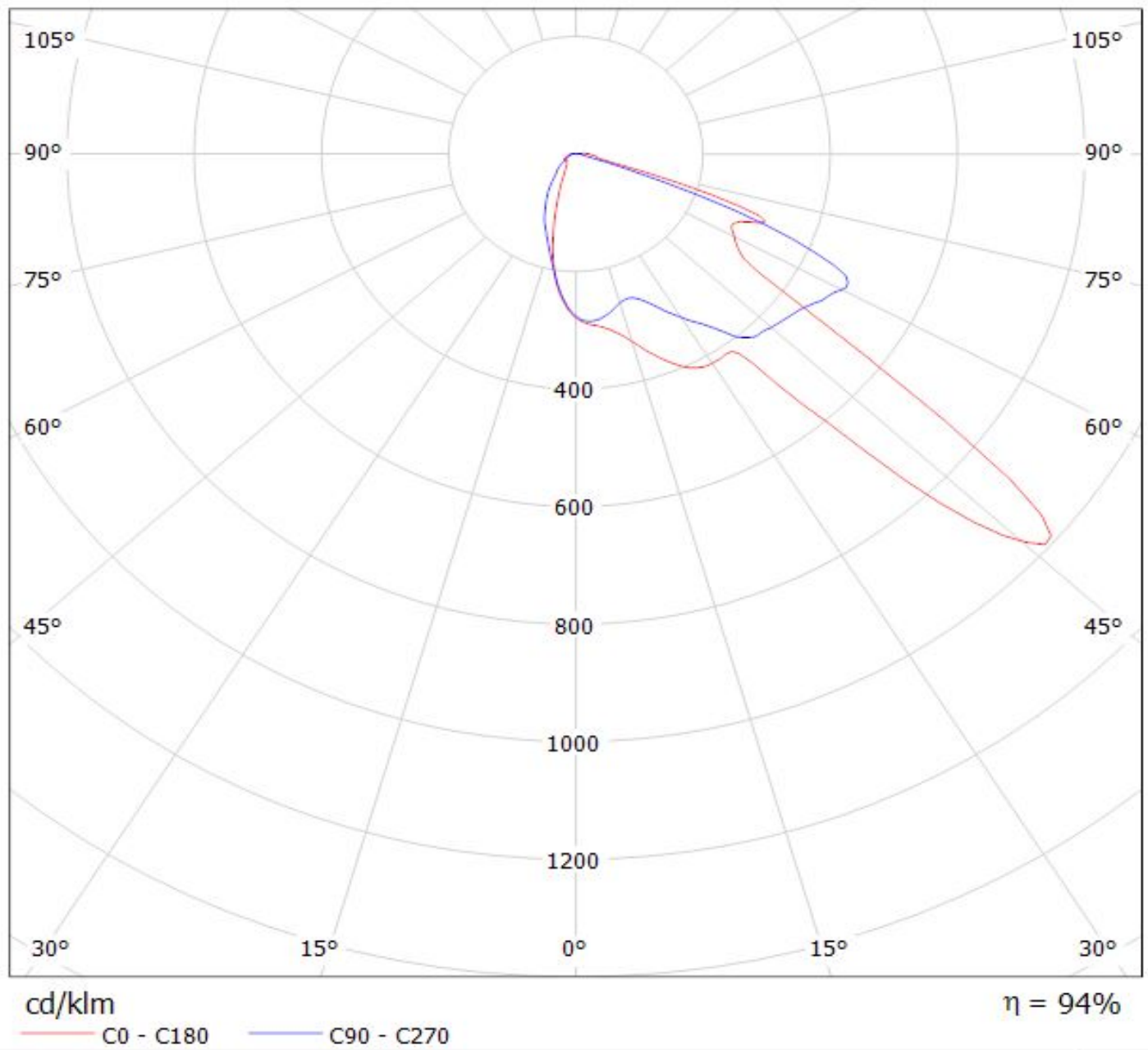

Luminaire: LEDiL Oy C14116_STRADA-2X2-PX_(SSL150)

Lamps: 1 x OSLOM_SSL150_2x2_284.9lm@250mA_CCT=3154K_P=3.15274W_I=249.9mA

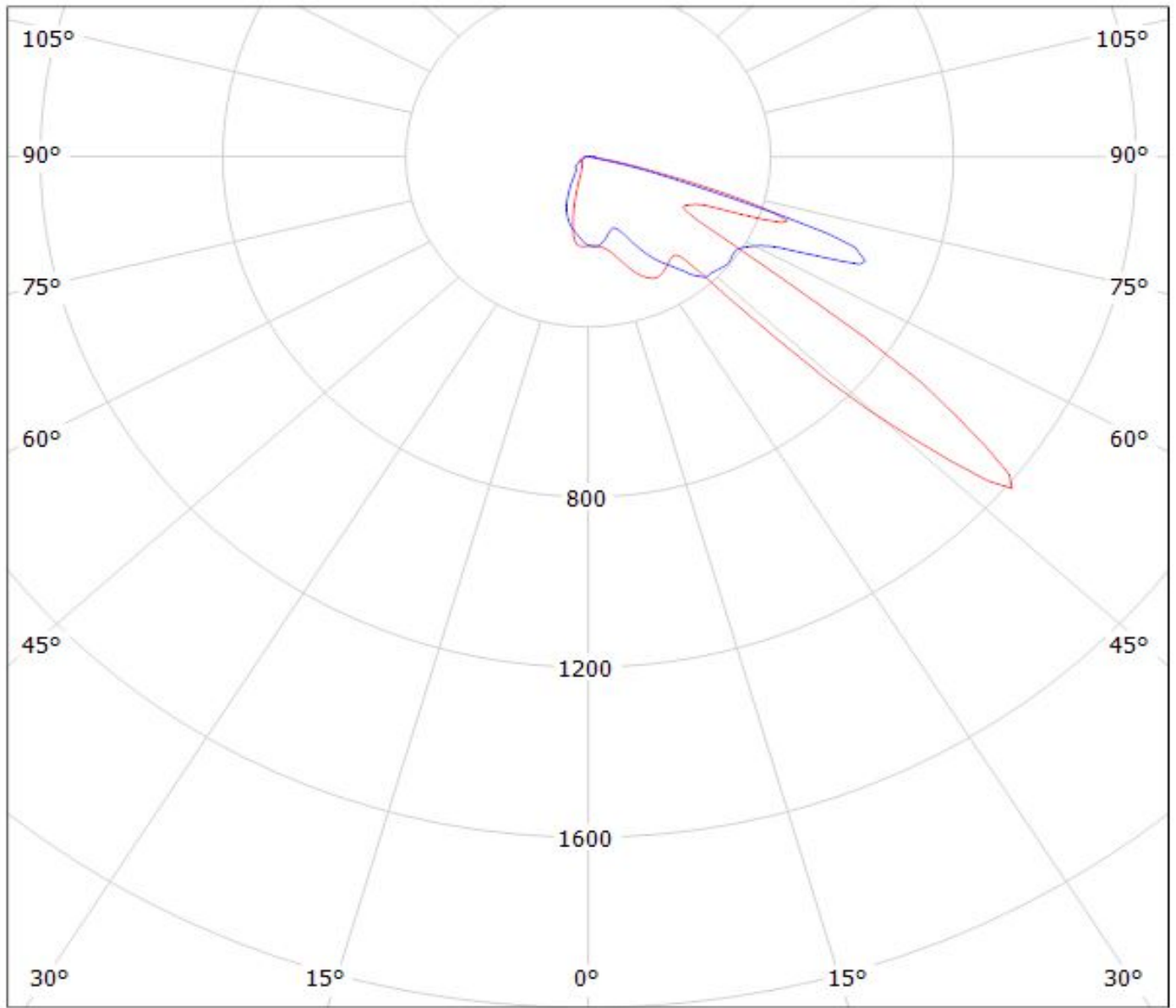

cd/klm

— C0 - C180 — C90 - C270

$\eta = 94\%$

Luminaire: LEDiL Oy C14116_STRADA-2X2-PX_(XB-D)

Lamps: 1 x CREE_XB-D_2x2_366.34lm@250mA_P=3.07877W_I=249.9mA

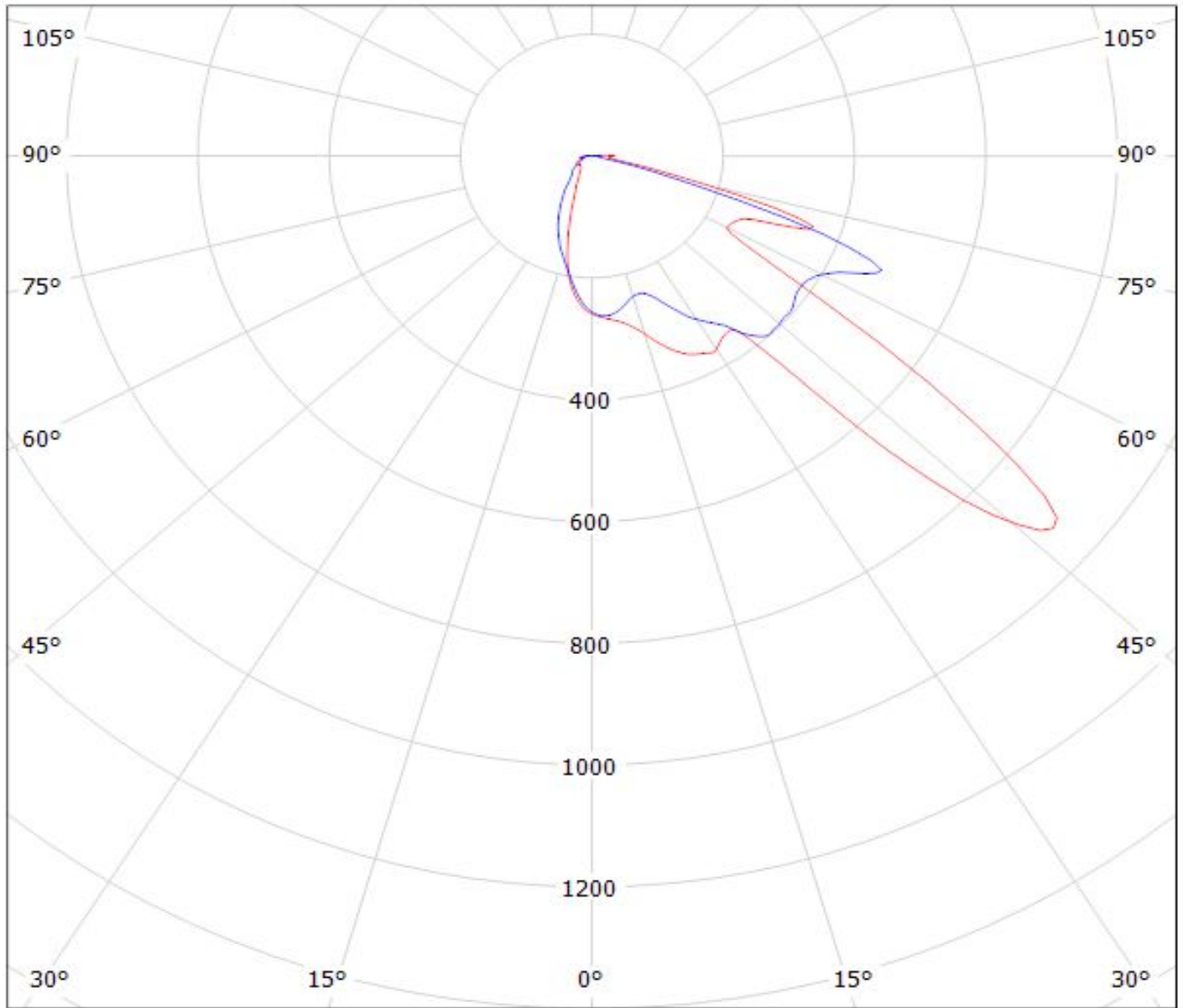

cd/klm

— C0 - C180

— C90 - C270

$\eta = 94\%$

Luminaire: LEDiL Oy C14116_STRADA-2X2-PX_(SSL80)

Lamps: 1 x OSLOM_SSL80_2x2_314.4lm@250mA_CCT=6775K_P=3.16548W_I=249.9mA

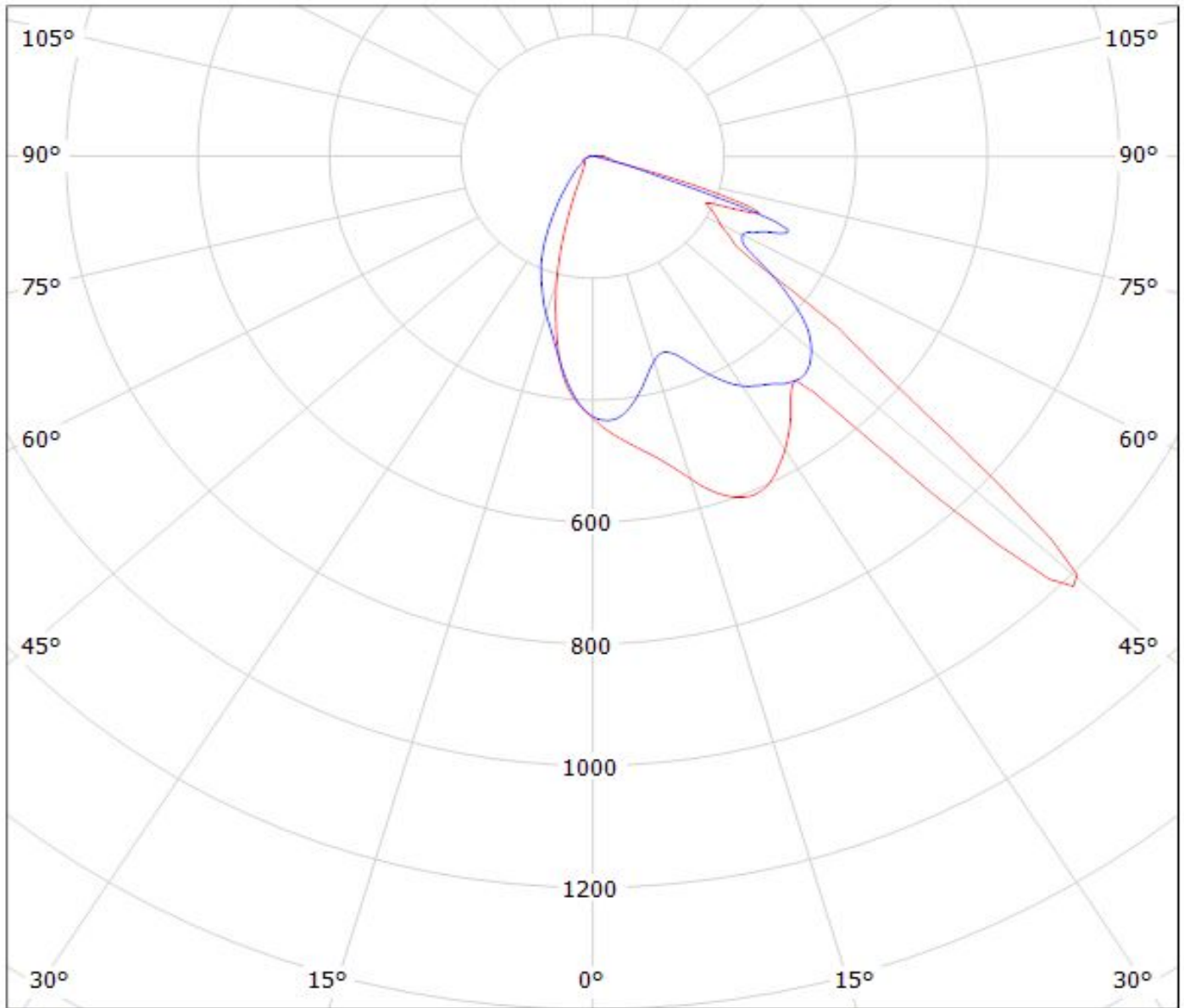

cd/klm

— C0 - C180 — C90 - C270

$\eta = 94\%$

Luminaire: LEDiL Oy C14116_STRADA-2X2-PX_(NCSxx19B)
Lamps: 1 x NICHIA_NCSxx19B_(NCSW119BE)
_2x2_439.5lm@250mA_CCT=5403K_P=3.0083W_I=249.9mA

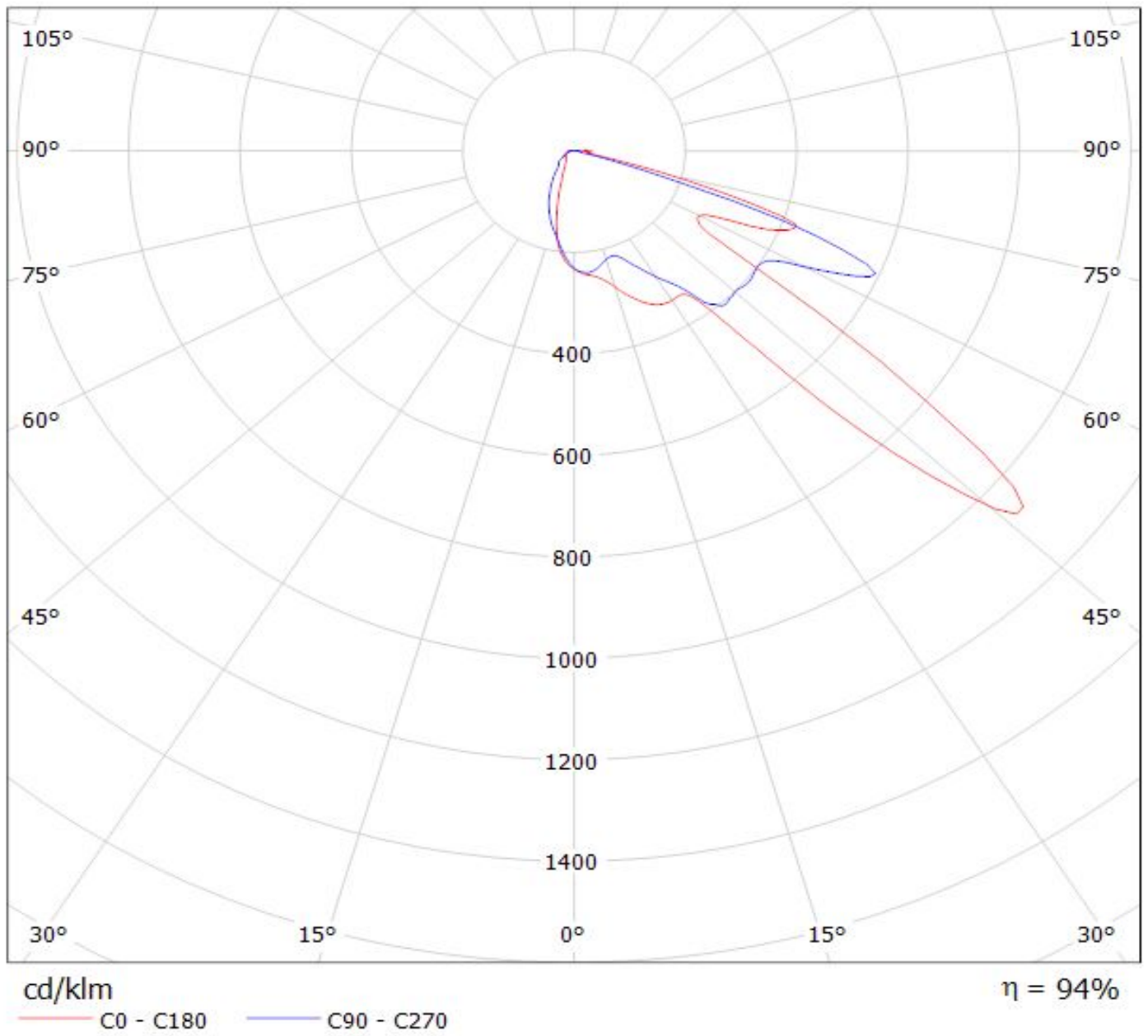

Luminaire: LEDiL Oy C14116_STRADA-2X2-PX_(LUXEON_T)

Lamps: 1 x LUXEON_T_2x2_(LXH8-FW30-3)_294.67lm@250mA_P=2.806W_I=249.8mA

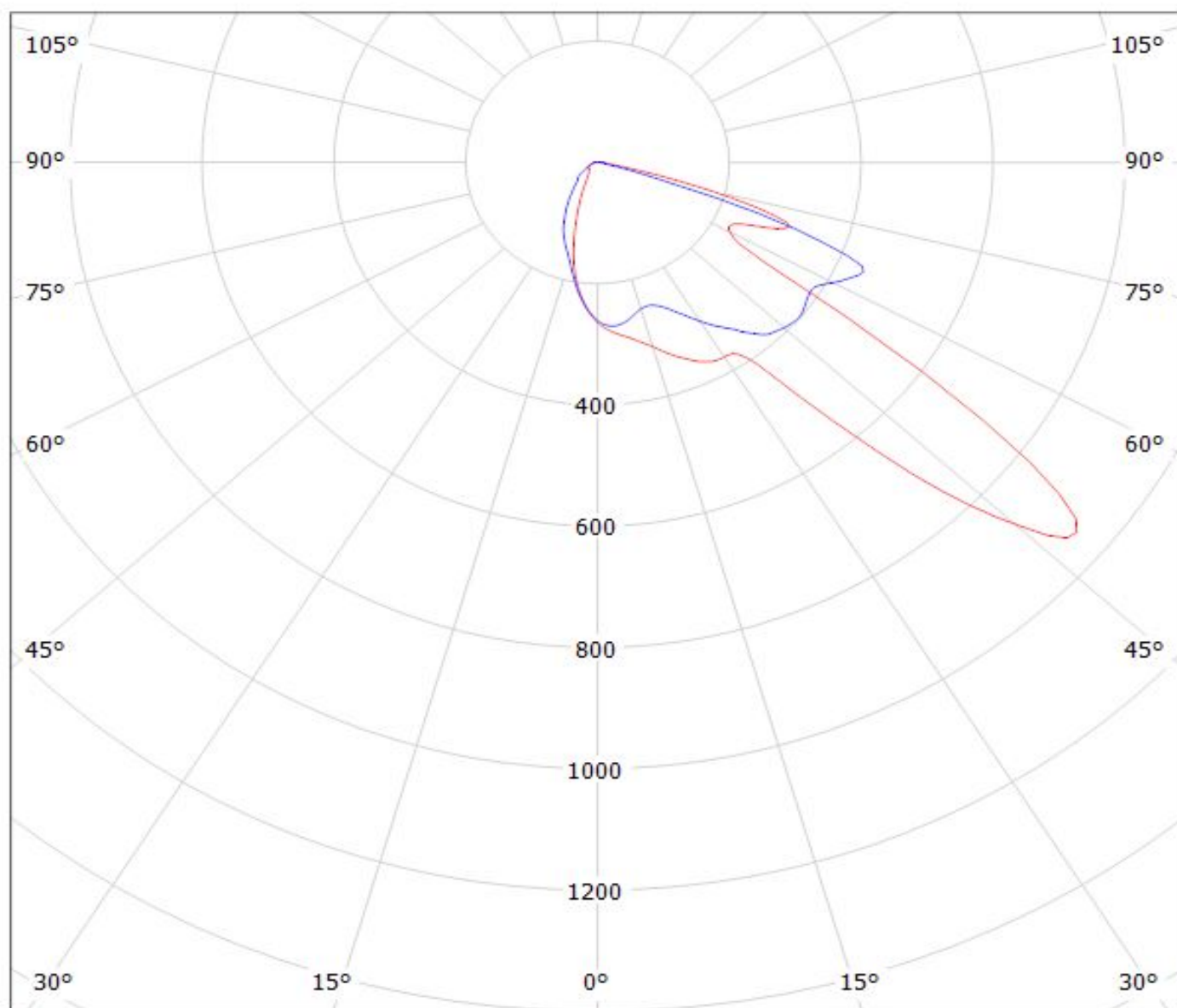

cd/klm

— C0 - C180

— C90 - C270

$\eta = 94\%$

Luminaire: LEDiL Oy C14116_STRADA-2X2-PX_(REBEL_ES)

Lamps: 1 x LUXEON_REBEL_ES_2x2_340.26lm@250mA_P=2.87295W_I=249.8mA

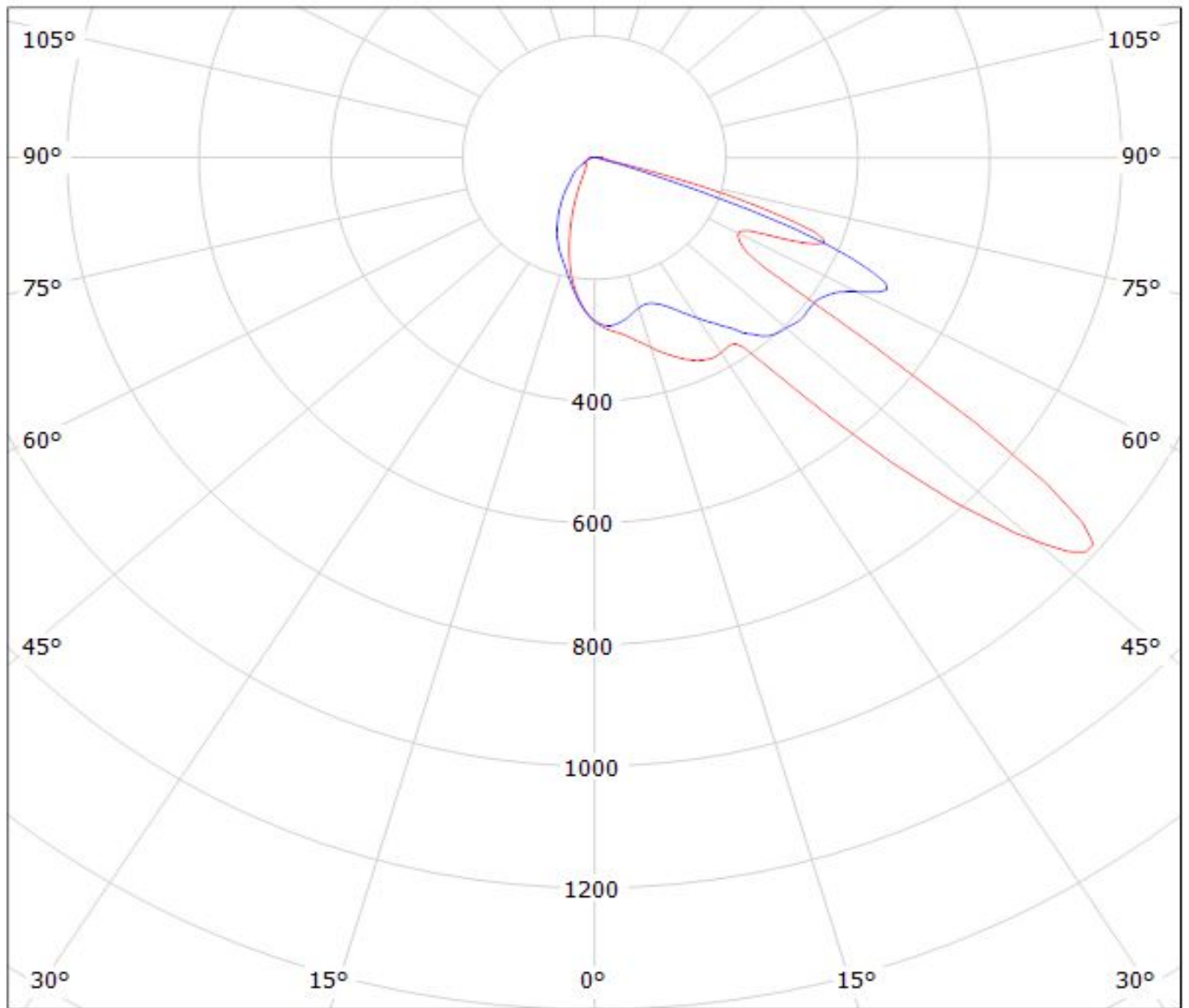

cd/klm

— C0 - C180

— C90 - C270

$\eta = 94\%$

Luminaire: LEDiL Oy C14116_STRADA-2X2-PX_(XP-E)
Lamps: 1 x Cree_XP-E_2x2_(XPEWHT-L1-3C0-Q5-0-06)
_305.07lm@250mA_CCT=5434K_P=3.06902W_I=249.9mA

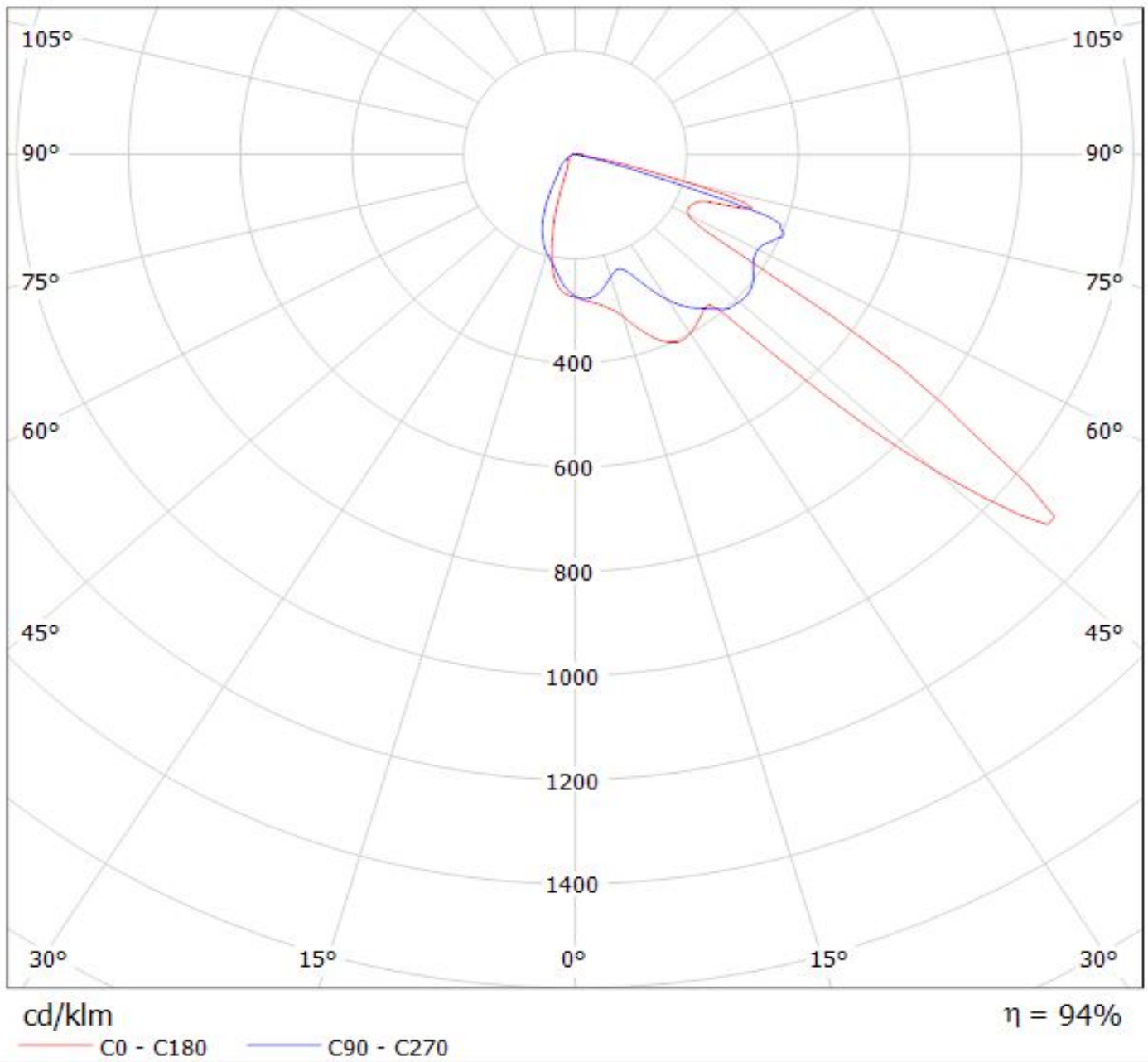

Luminaire: LEDiL Oy C14116_STRADA-2X2-PX_(Z5)

Lamps: 1 x SEOUL_Z5_(SZW05A0B)_339.3lm@250mA_P=3.01134W_I=249.8mA

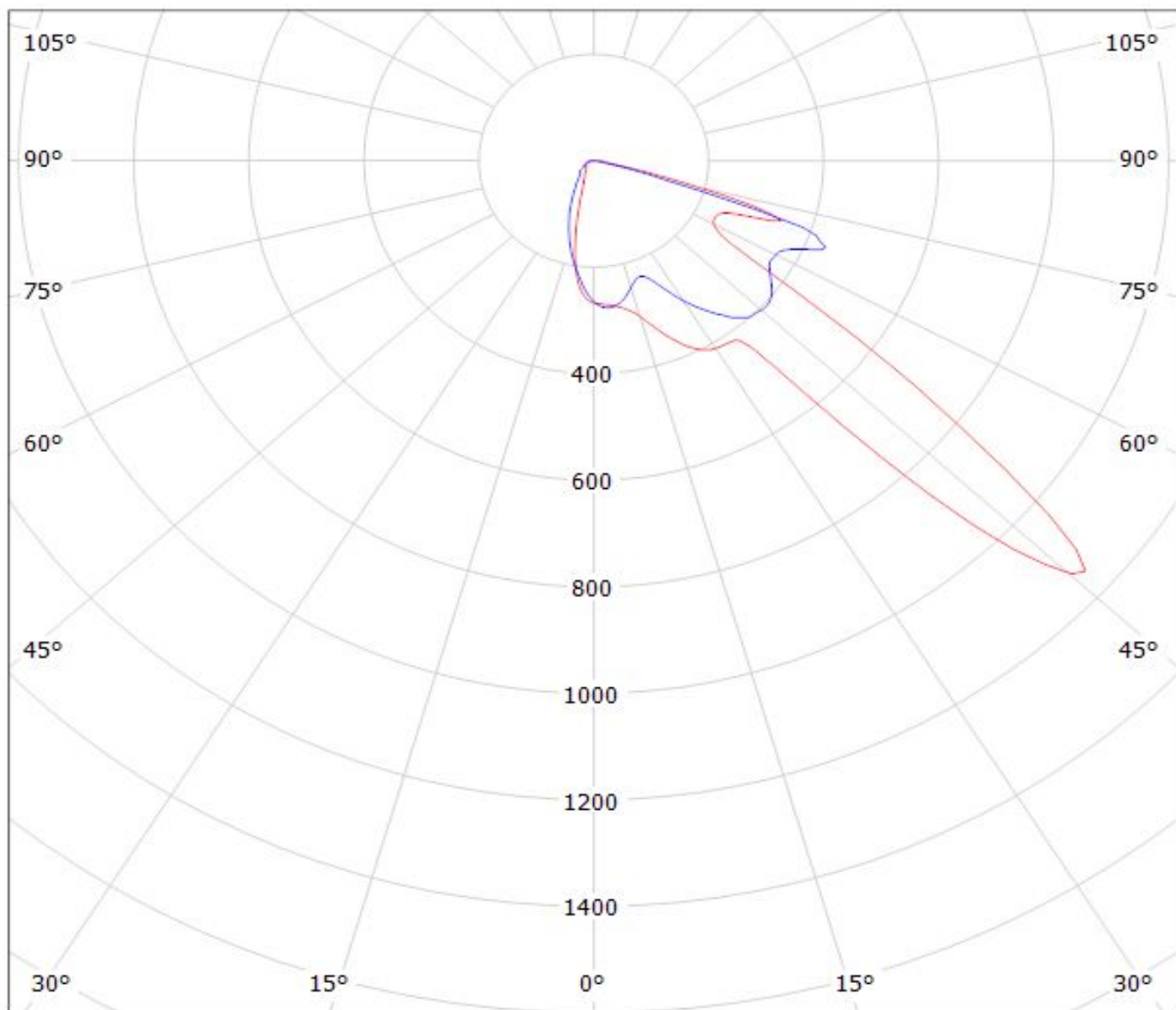

cd/klm

— C0 - C180

— C90 - C270

$\eta = 94\%$

Luminaire: LEDiL Oy C14116_STRADA-2X2-PX_(LH351A)

Lamps: 1 x Samsung_LH351A_2x2_339.2lm@250mA_P=3.20997W_I=249.9mA

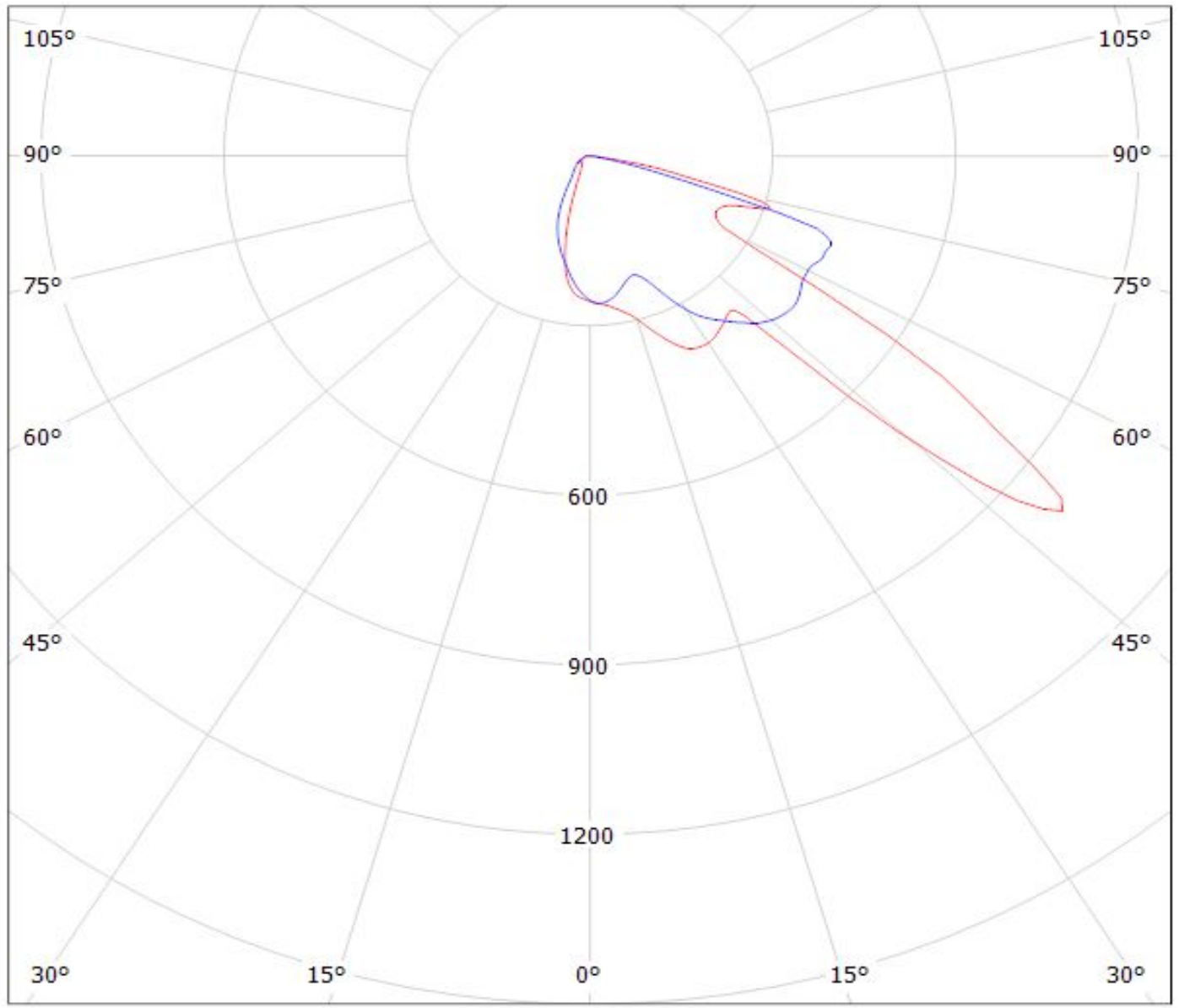

cd/klm

— C0 - C180 — C90 - C270

$\eta = 94\%$

Luminaire: LEDiL Oy C14116_STRADA-2X2-PX_(H35C0)

Lamps: 1 x LG_H35C0_2x2_371.8lm@250mA_P=2.94332W_I=249.9mA

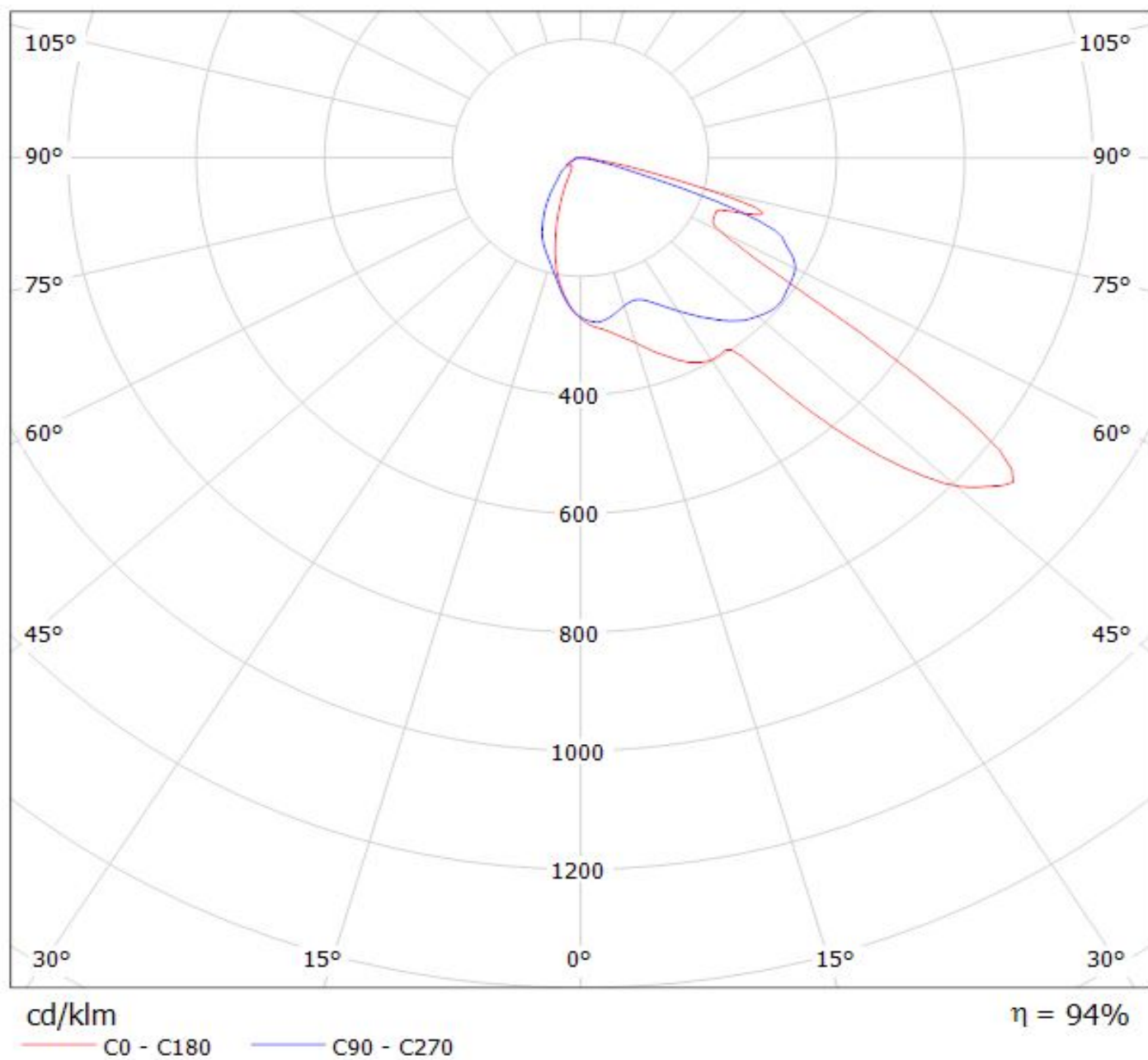

Luminaire: LEDiL Oy C14116_STRADA-2X2-PX_(H35C1)

Lamps: 1 x LG_H35C1_2x2_469.35lm@250mA_P=2.86535W_I=249.9mA

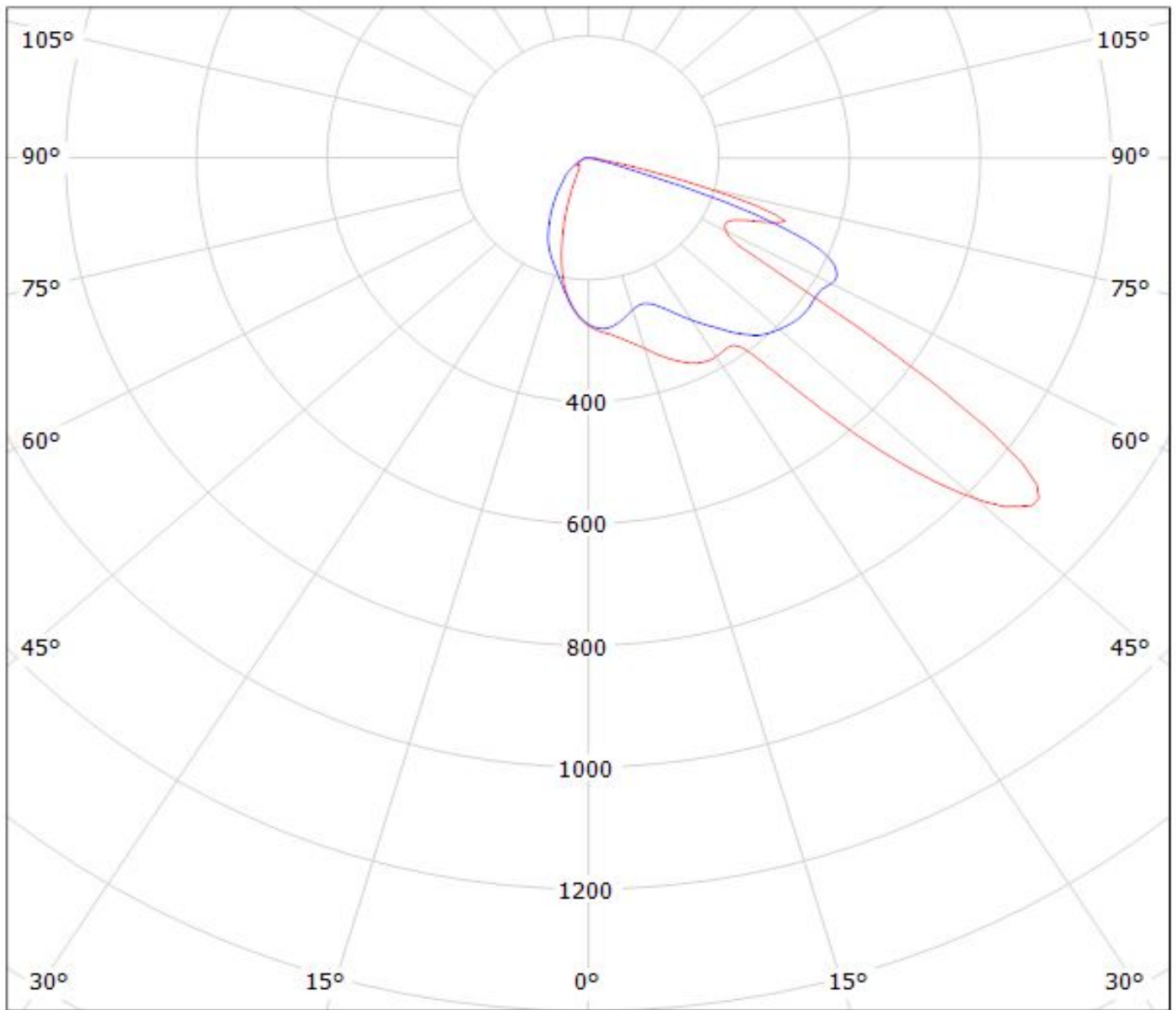

cd/klm

$\eta = 94\%$

— C0 - C180

— C90 - C270

Luminaire: LEDiL Oy C14116_STRADA-2X2-PX_(NS9x383)

Lamps: 1 x NICHIA_NS9x383_(NS9W383T)_2x2_380.85lm@250mA_P=2.8856W_I=249.9mA

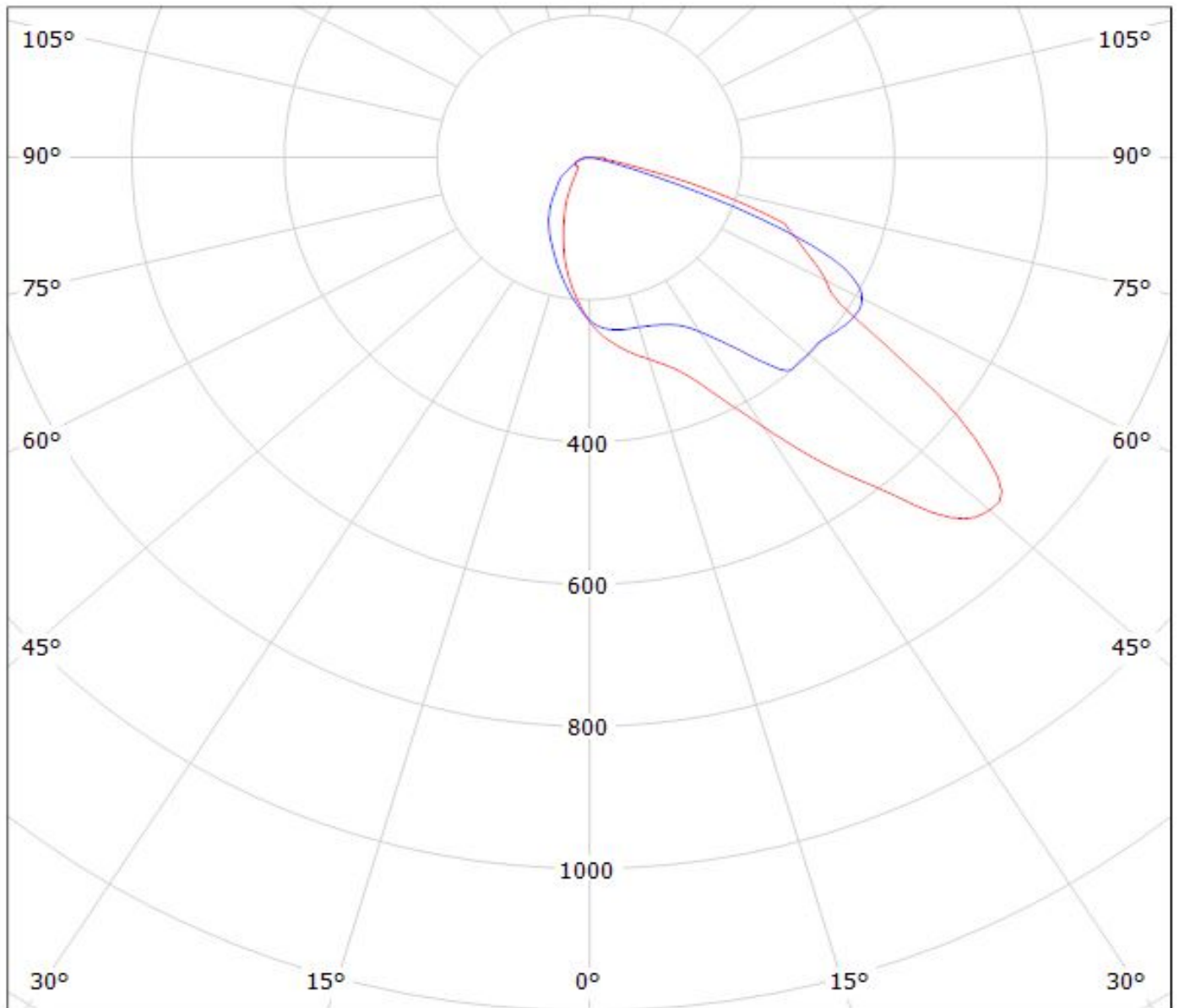

cd/klm

— C0 - C180

— C90 - C270

$\eta = 94\%$

Luminaire: LEDiL Oy C14116_STRADA-2X2-PX_(NVSxx19B)
Lamps: 1 x NICHIA_NVsxx19B_(NVS219BE)
_2x2_315lm@250mA_CCT=3071K_U=2.88235W_I=249.9mA

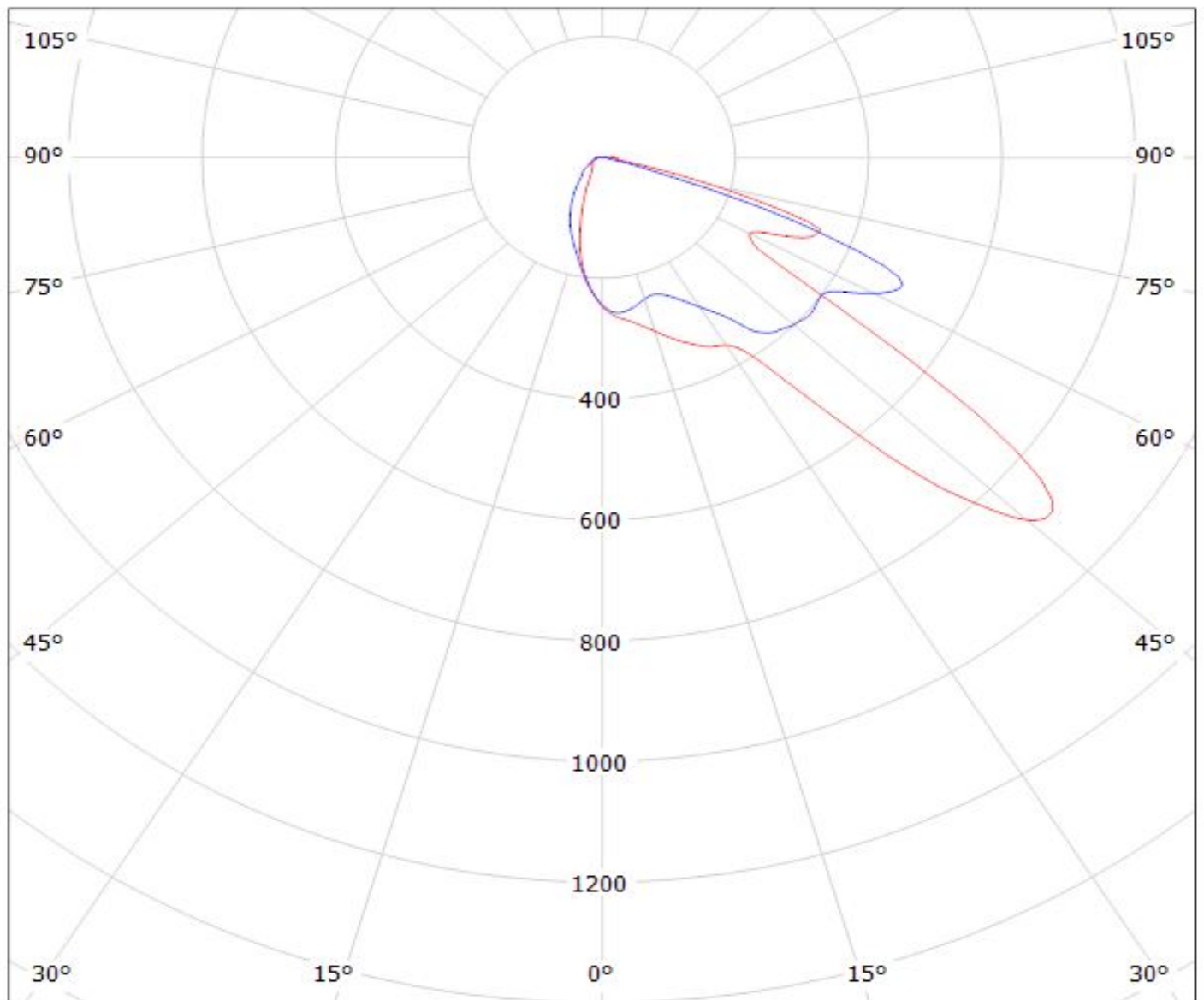

cd/klm

— C0 - C180 — C90 - C270

$\eta = 94\%$

Ledil C14116_STRADA-2X2-PX_(TL1L4) / LDC (Polar)

Luminaire: Ledil C14116_STRADA-2X2-PX_(TL1L4)

Lamps: 1 x Toshiba_TL1L4_2x2_(TL1L4-DW0)_472.639lm@250mA_CCT=6500K_P=2.9W_I=0.25A

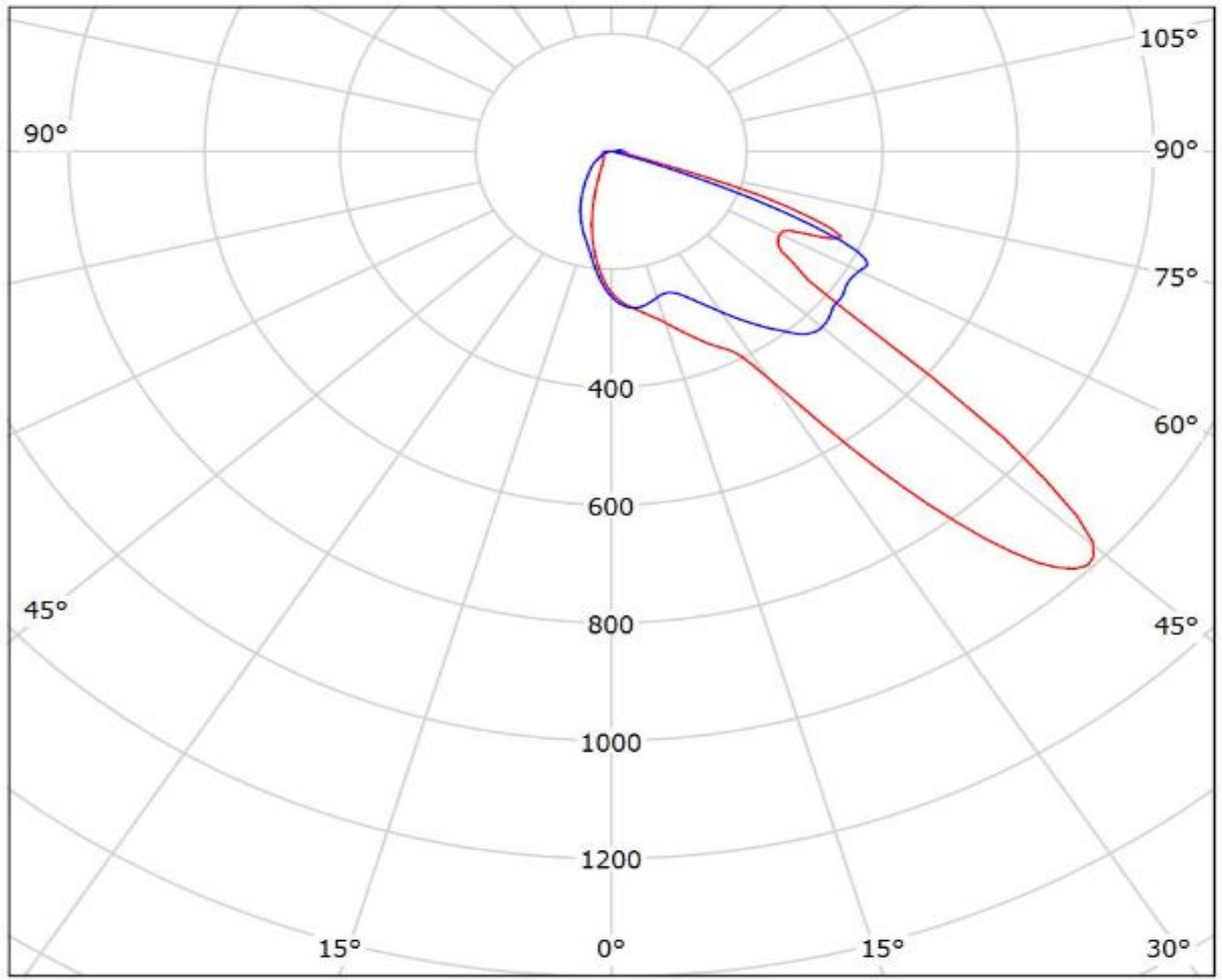

cd/klm

— C0 - C180 — C90 - C270

$\eta = 91\%$

Luminaire: LEDiL Oy C14116_STRADA-2X2-PX_(Fortimo_F-Flex_2x8_740DAG3)
Lamps: 1 x Philips_Fortimo_F-Flex_2x8_740DAG3_1780.2lm@250mA_P=11.6112W_I=0.2498A

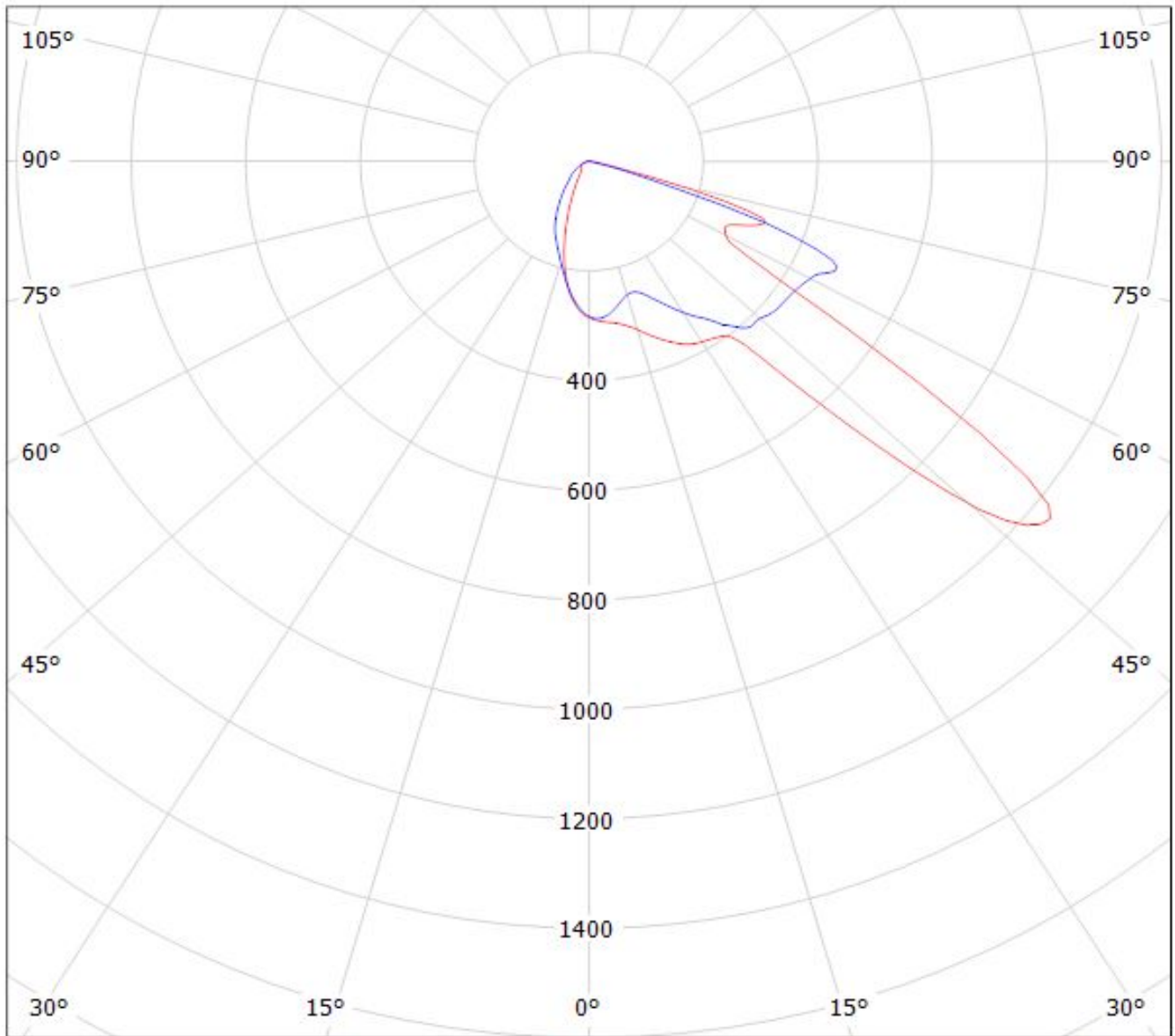

cd/klm

$\eta = 96\%$

— C0 - C180 — C90 - C270

Luminaire: LEDiL Oy C14116_STRADA-2x2-PX_(Z5M1)
Lamps: 1 x SEOUL_Z5M1_2x2_(SZ5-M1-WN-C8)
_391.15lm@250mA_CCT=4587K_P=2.86086W_I=249.9mA

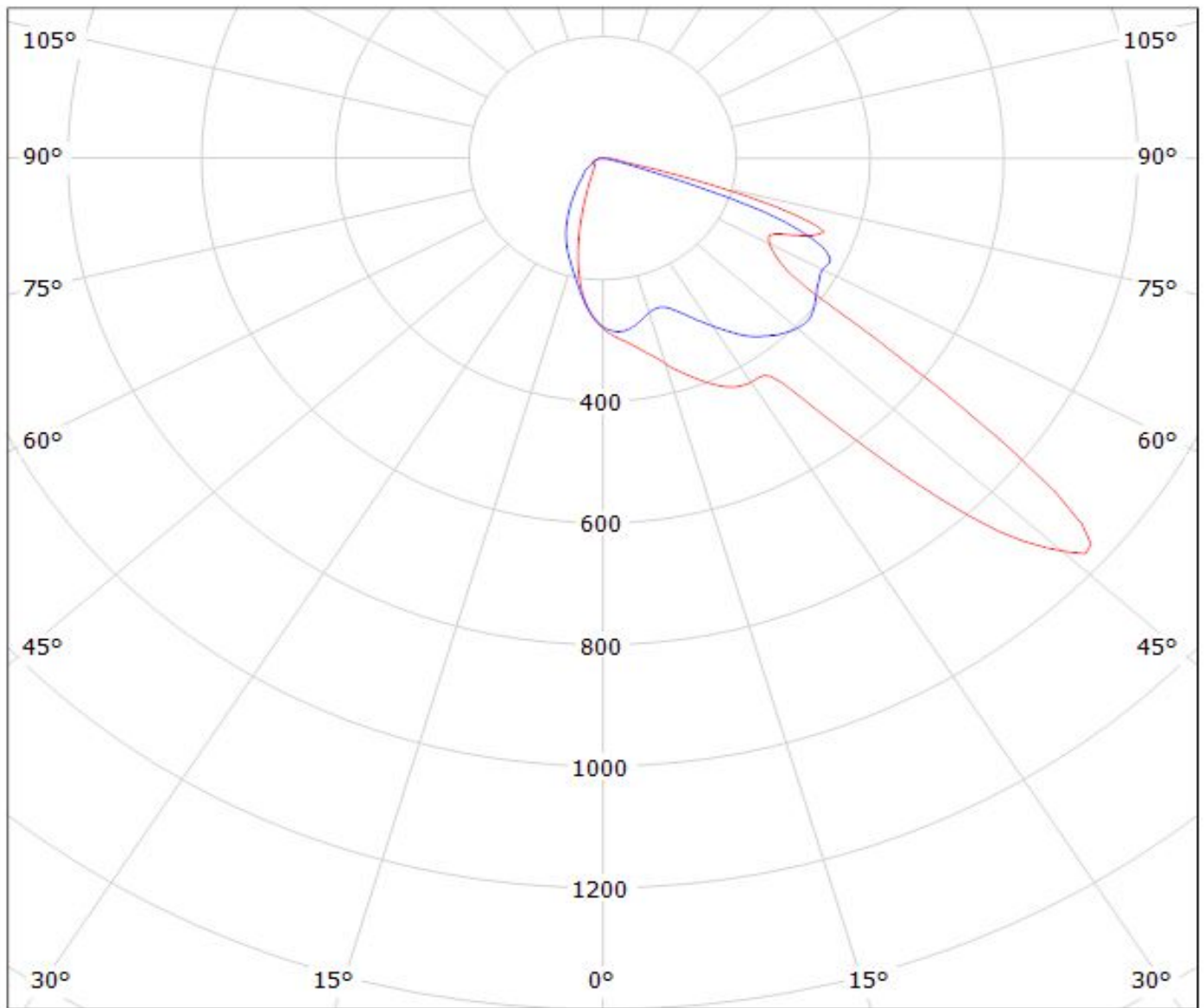

cd/klm

— C0 - C180 — C90 - C270

$\eta = 94\%$

Luminaire: LEDiL Oy C14116_STRADA-2x2-PX_(Z5M)

Lamps: 1 x SEOUL_Z5M_2x2_(SZ5-M0-W0-00)_366.55lm@250mA_P=2.96931W_I=249.9mA

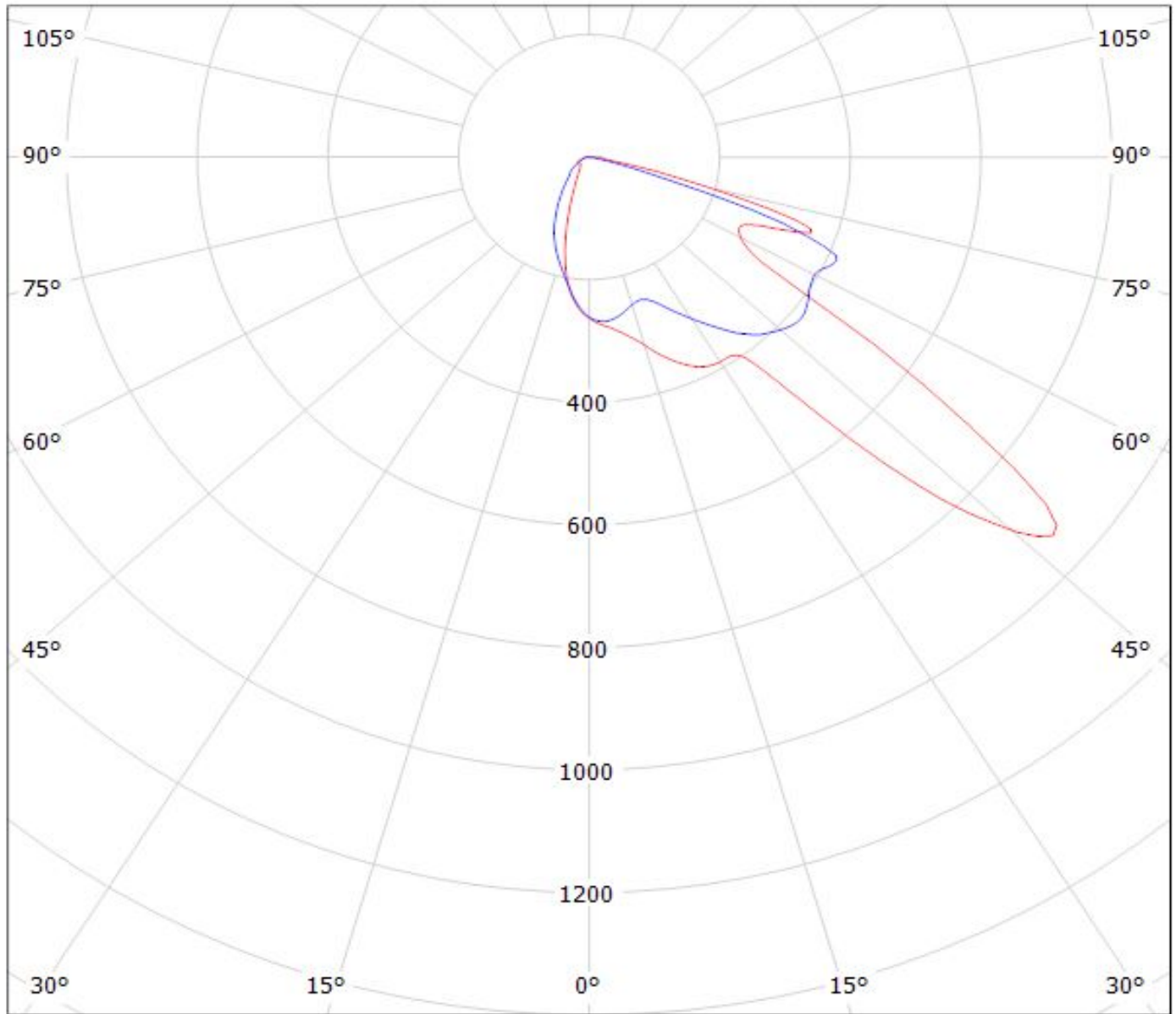

cd/klm

— C0 - C180

— C90 - C270

$\eta = 94\%$

Luminaire: LEDiL Oy C14116_STRADA-2x2-PX_(LH351Z)

Lamps: 1 x SAMSUNG_LH351Z_2x2_(SZ5-M0-W0-00)_363.65lm@250mA_P=2.86635W_I=249.9mA

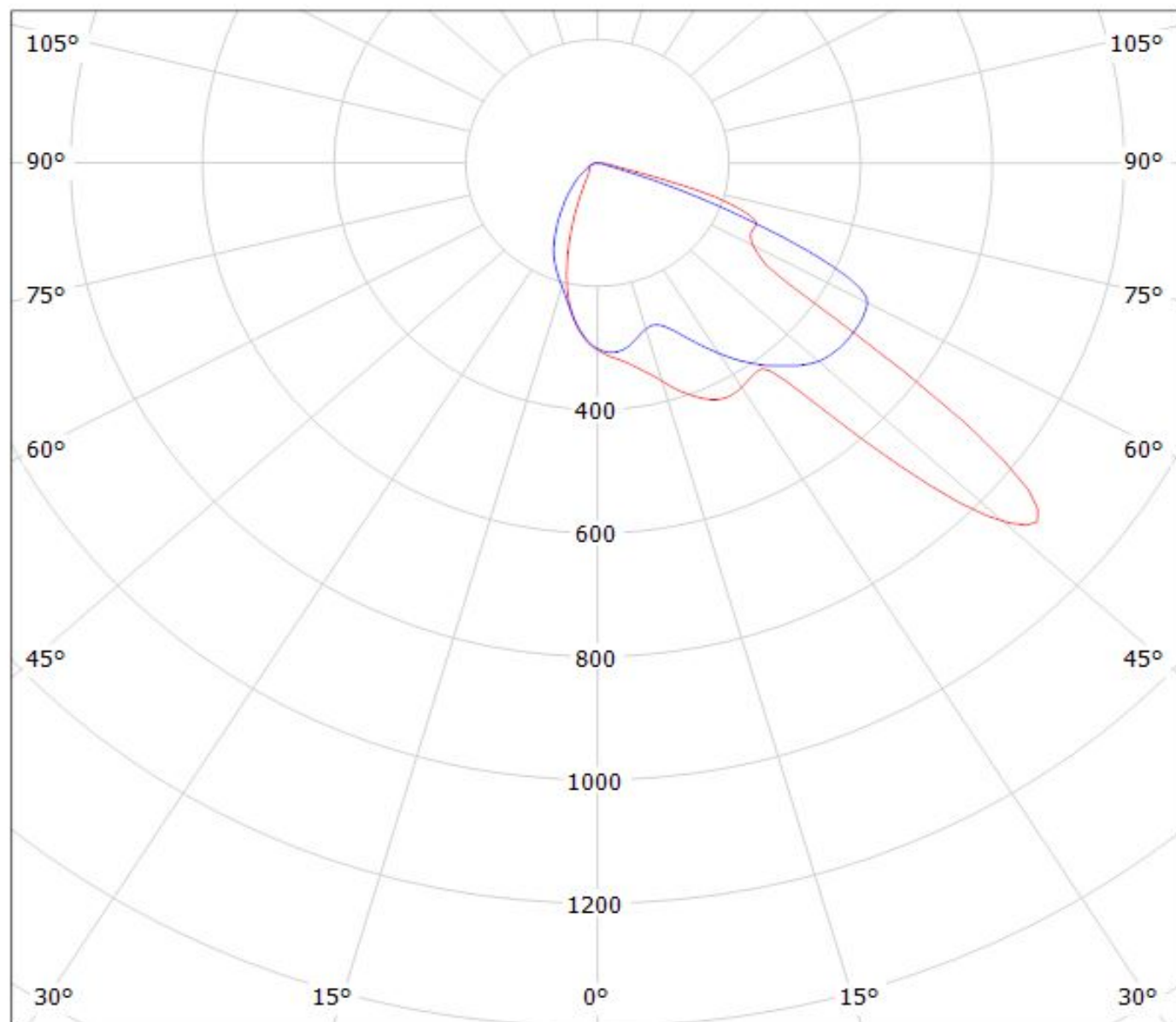

cd/klm

— C0 - C180

— C90 - C270

$\eta = 94\%$

Luminaire: LEDiL Oy C14116_STRADA-2x2-PX_(ACRICH_MJT_4040)
Lamps: 1 x SEOUL_ACRICH_MJT_4040_2x2_(SAW09H0A)
_131.93lm@250mA_P=1.12281W_I=19.5mA

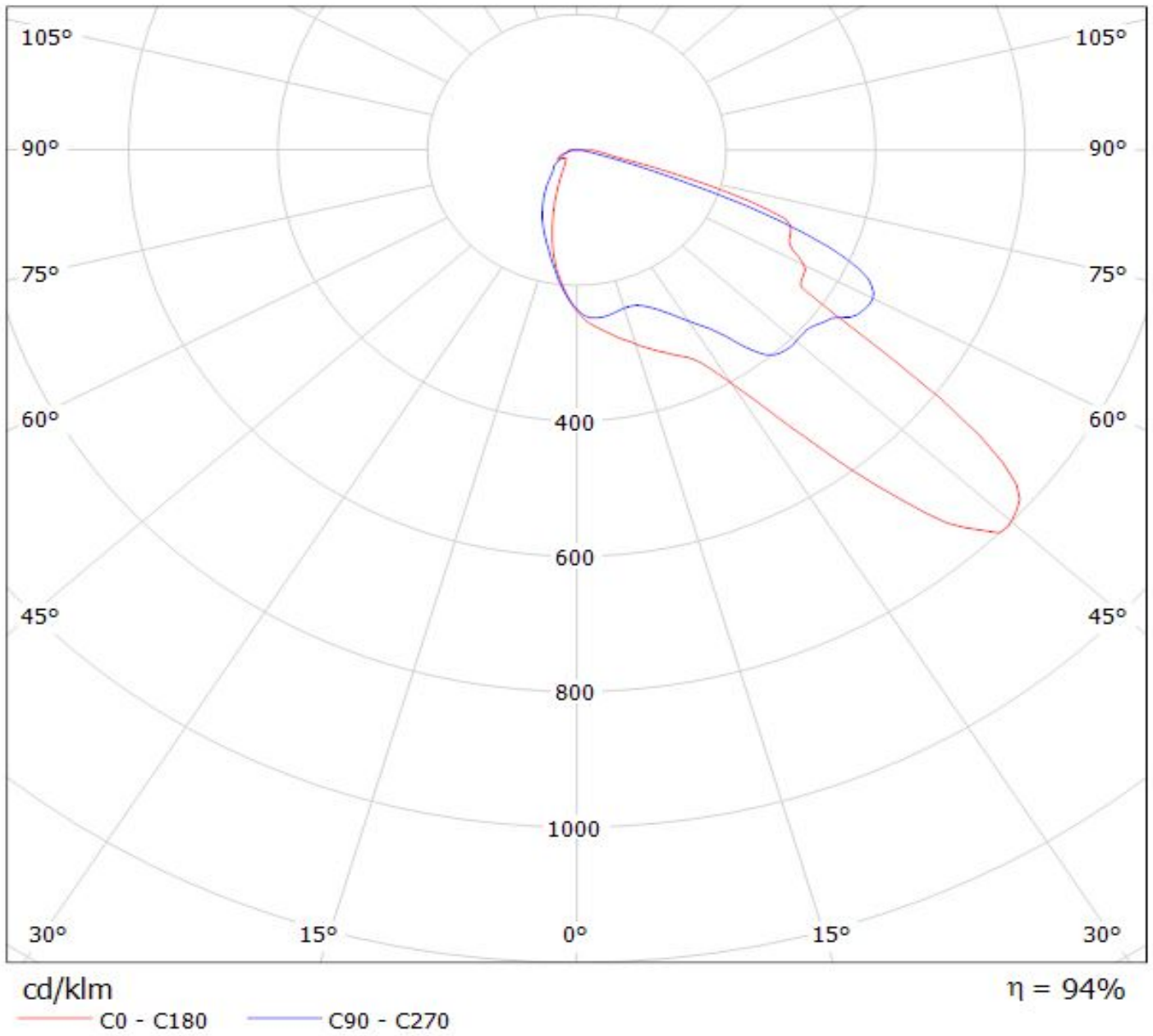

Luminaire: LEDiL Oy C14116_STRADA-2X2-PX_(XP-E2)

Lamps: 1 x CREE_XP-E2_2x2_(XPEBWT-L1-7B4-Q4-0-01)_340.5lm@250mA_P=2.93108W_I=249.9mA

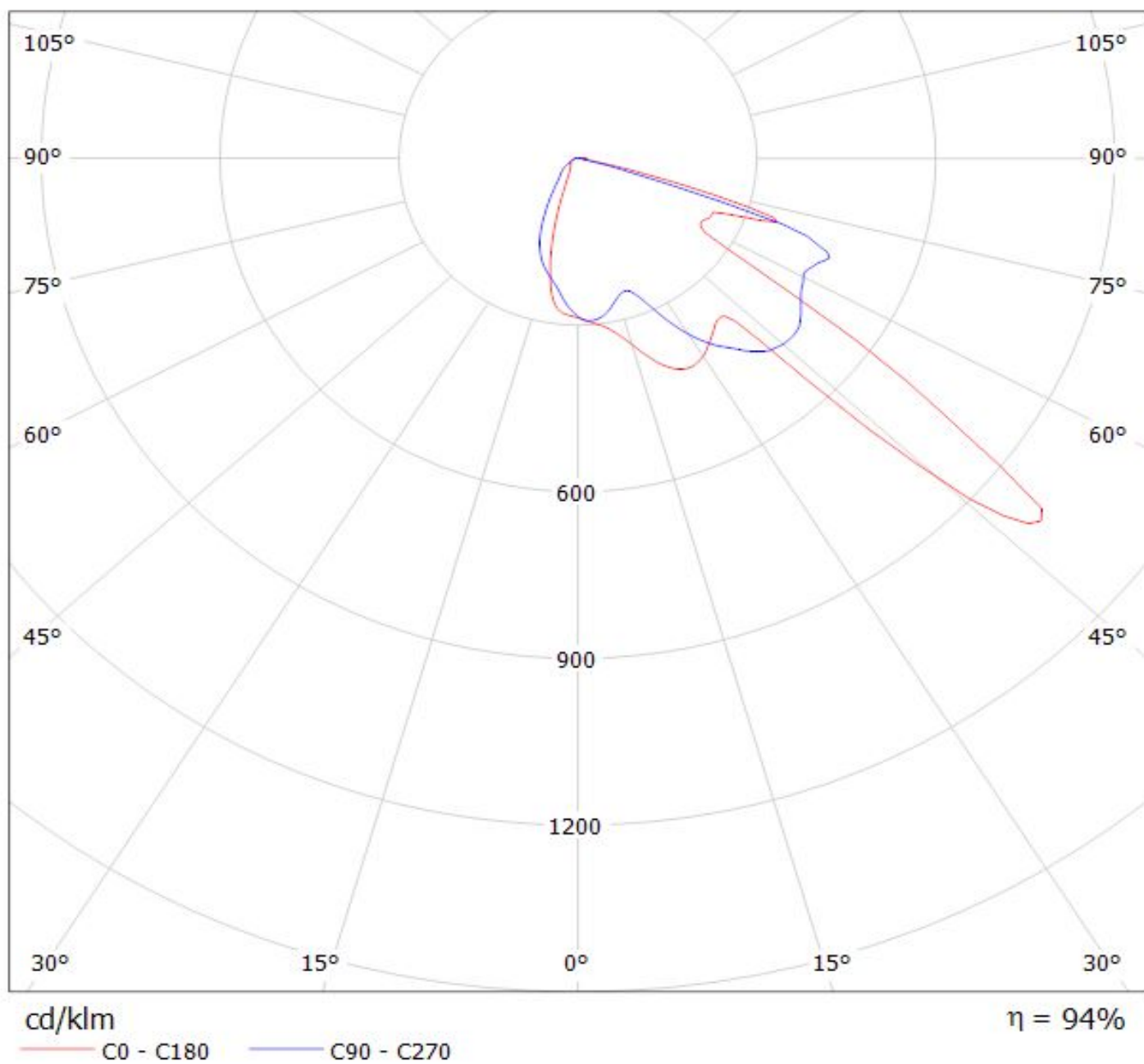

Luminaire: LEDiL Oy C14116_STRADA-2X2-PX_(XP-G)

Lamps: 1 x CREE_XP-G_2x2_259.15lm@250mA_P=2.90609W_I=249.9mA

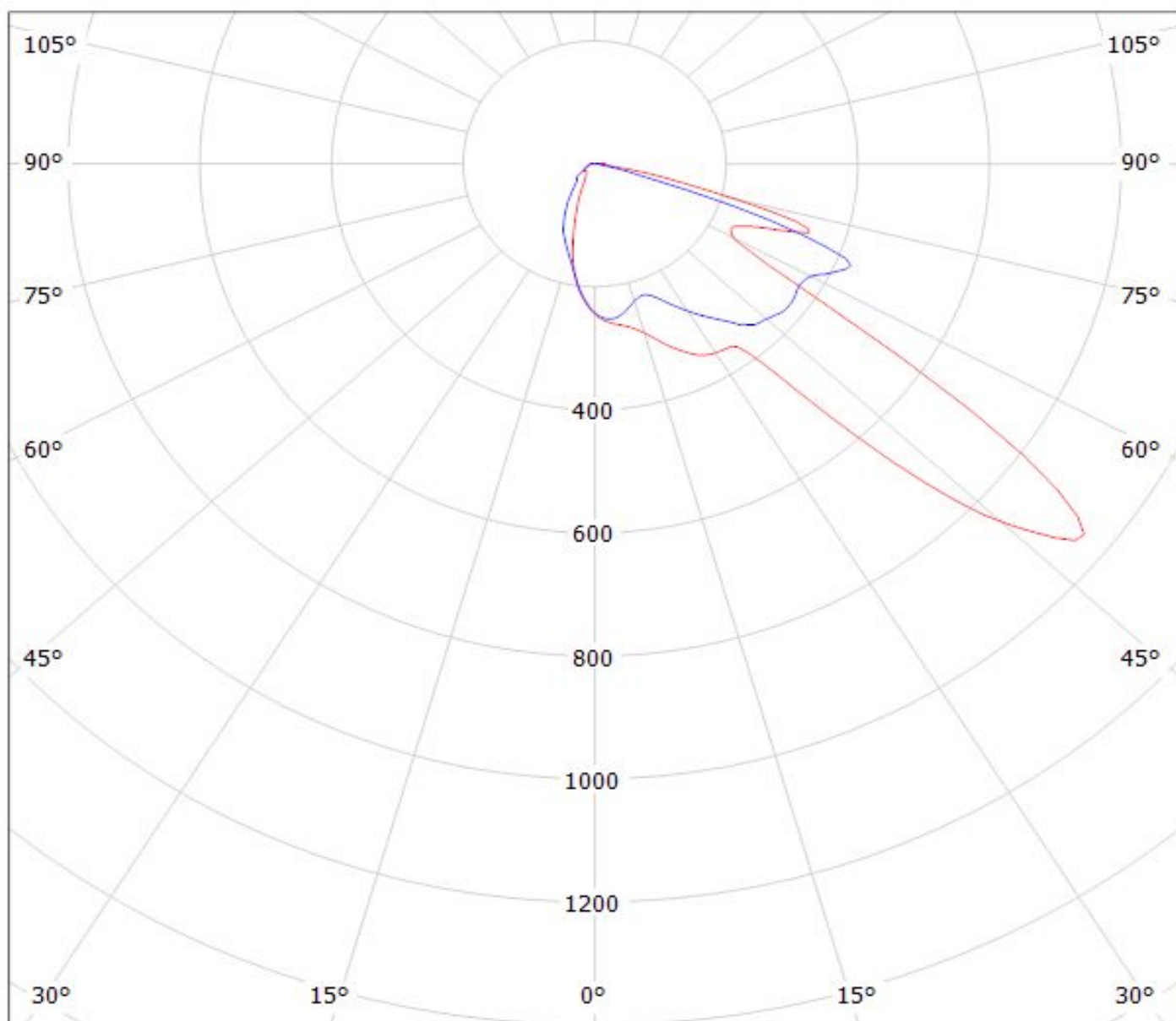

cd/klm

— C0 - C180

— C90 - C270

$\eta = 94\%$

Luminaire: LEDiL Oy C14116_STRADA-2X2-PX_(XB-H)
Lamps: 1 x Cree_XB-H_2x2_(XBHAWT-0-5A3-T50-0L-0001)
_442.65lm@250mA_P=2.96762W_I=249.8mA

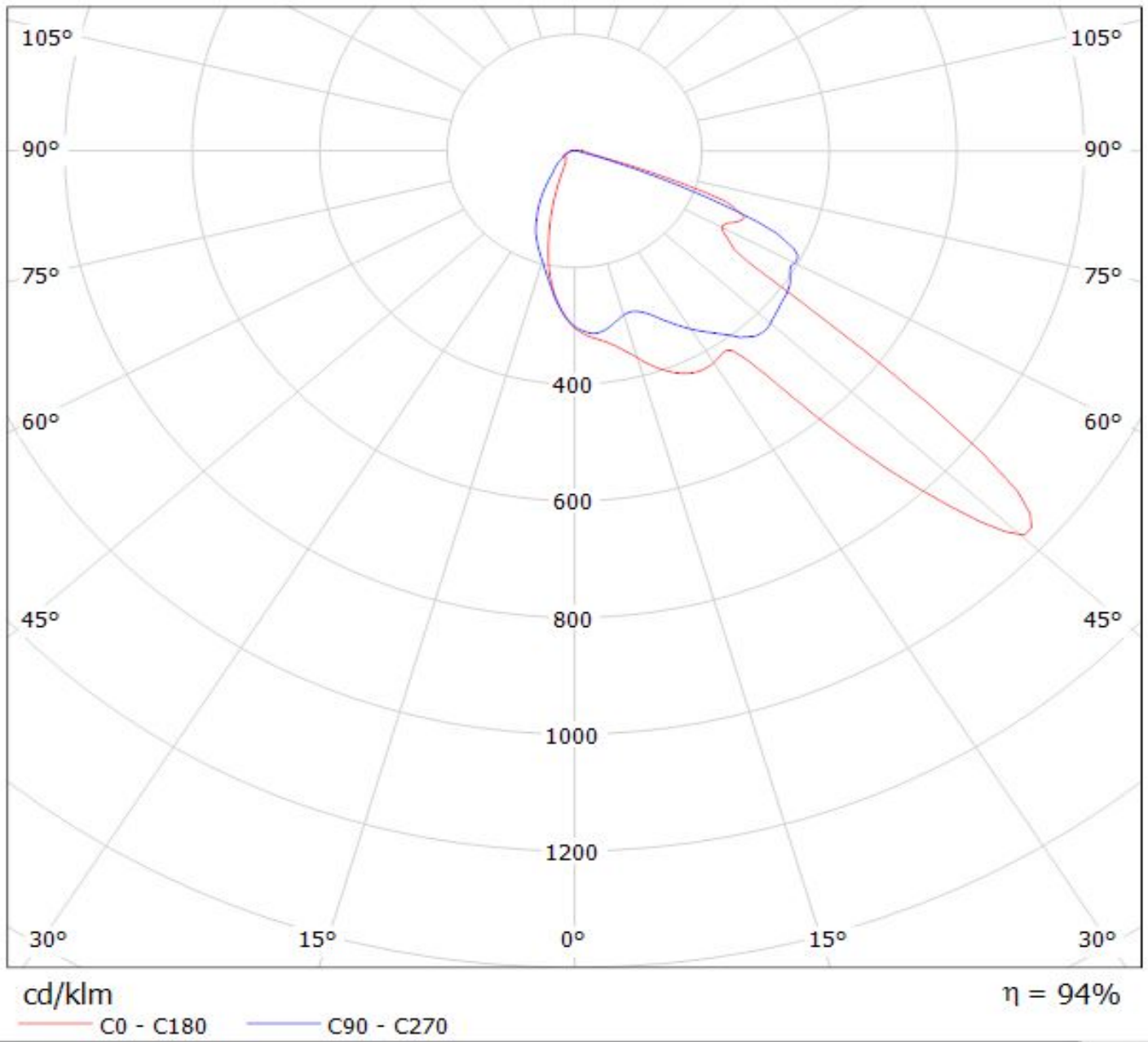

Luminaire: LEDiL Oy C14116_STRADA-2X2-PX_(XP-L)
Lamps: 1 x CREE_XP-L_2x2_(XPLAWT-0-1B0-V40-00-0001)
_508.5lm@250mA_CCT=7600K_P=2.80563W_I=249.9mA

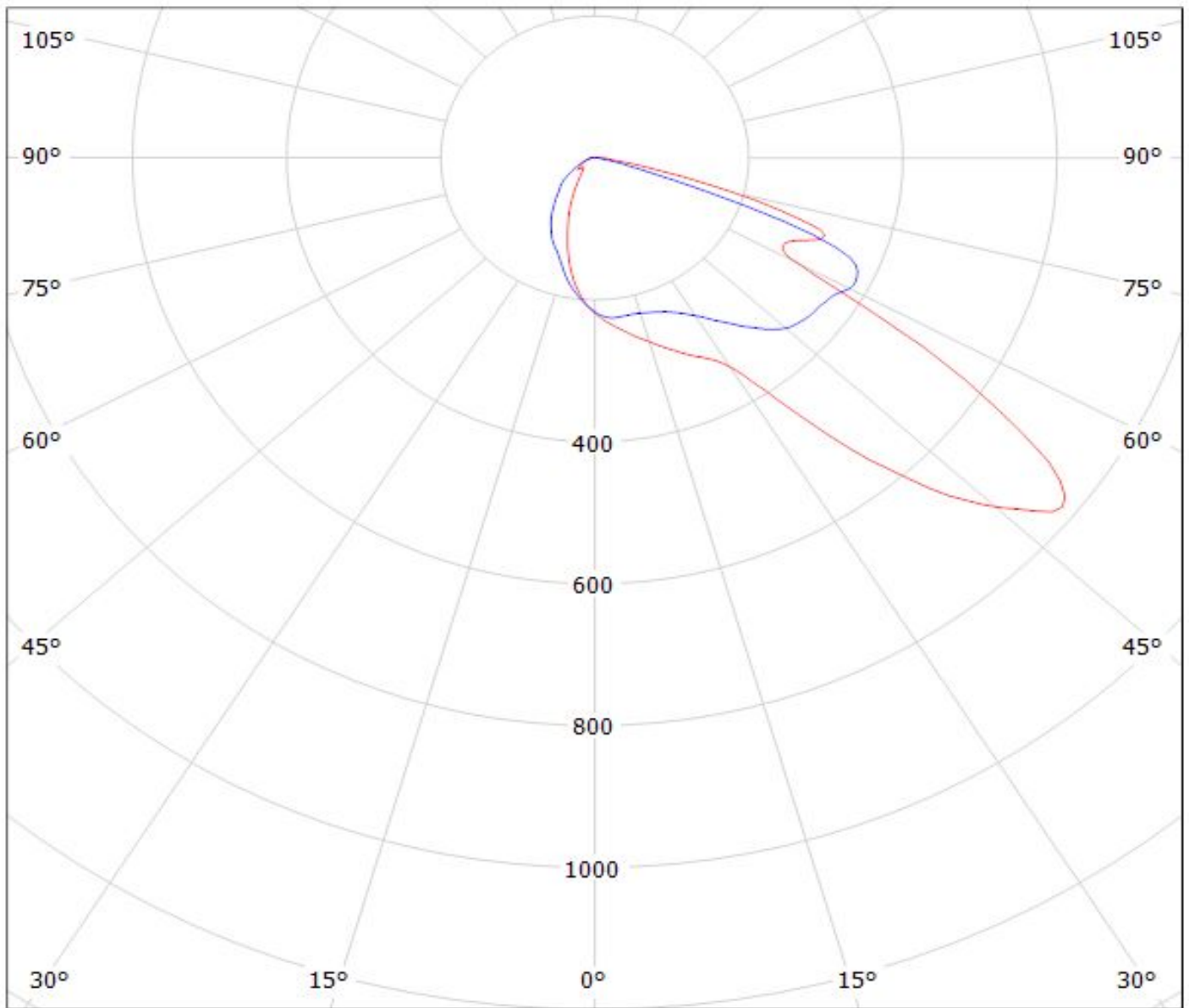

cd/klm

$\eta = 94\%$

— C0 - C180 — C90 - C270

Luminaire: LEDiL Oy C14116_STRADA-2X2-PX_(LUXEON_R)

Lamps: 1 x LUXEON_R_2x2_(LXA7-PW30)_314.95lm@250mA_P=2.78414W_I=249.9mA

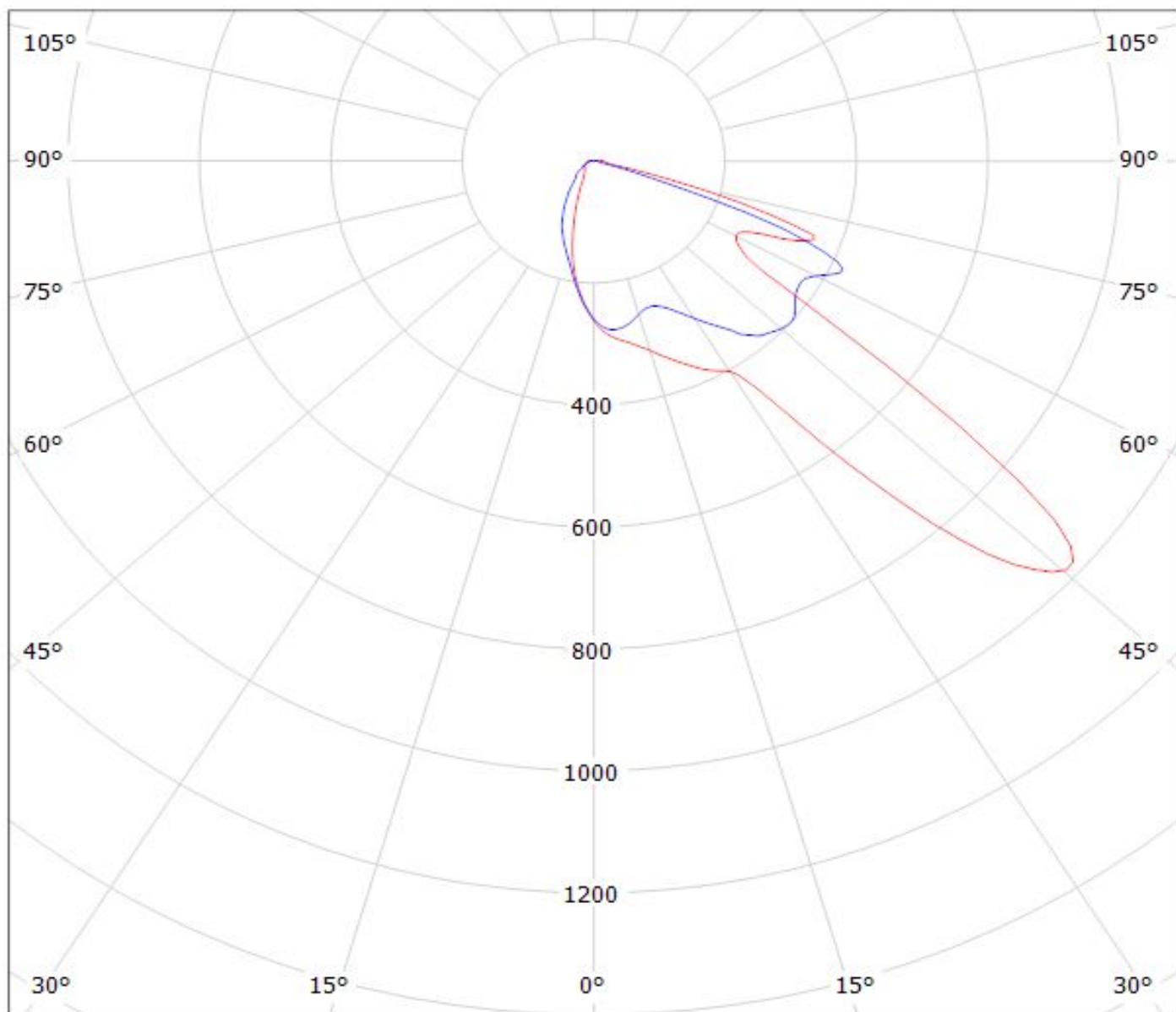

cd/klm

— C0 - C180

— C90 - C270

$\eta = 94\%$

Luminaire: LEDiL Oy C14116_STRADA-2X2-PX_(Z_ES)

Lamps: 1 x Luxeon_Z_ES_2x2_(LXZ2-3090)_214.14lm@250mA_P=2.82437W_I=249.9mA

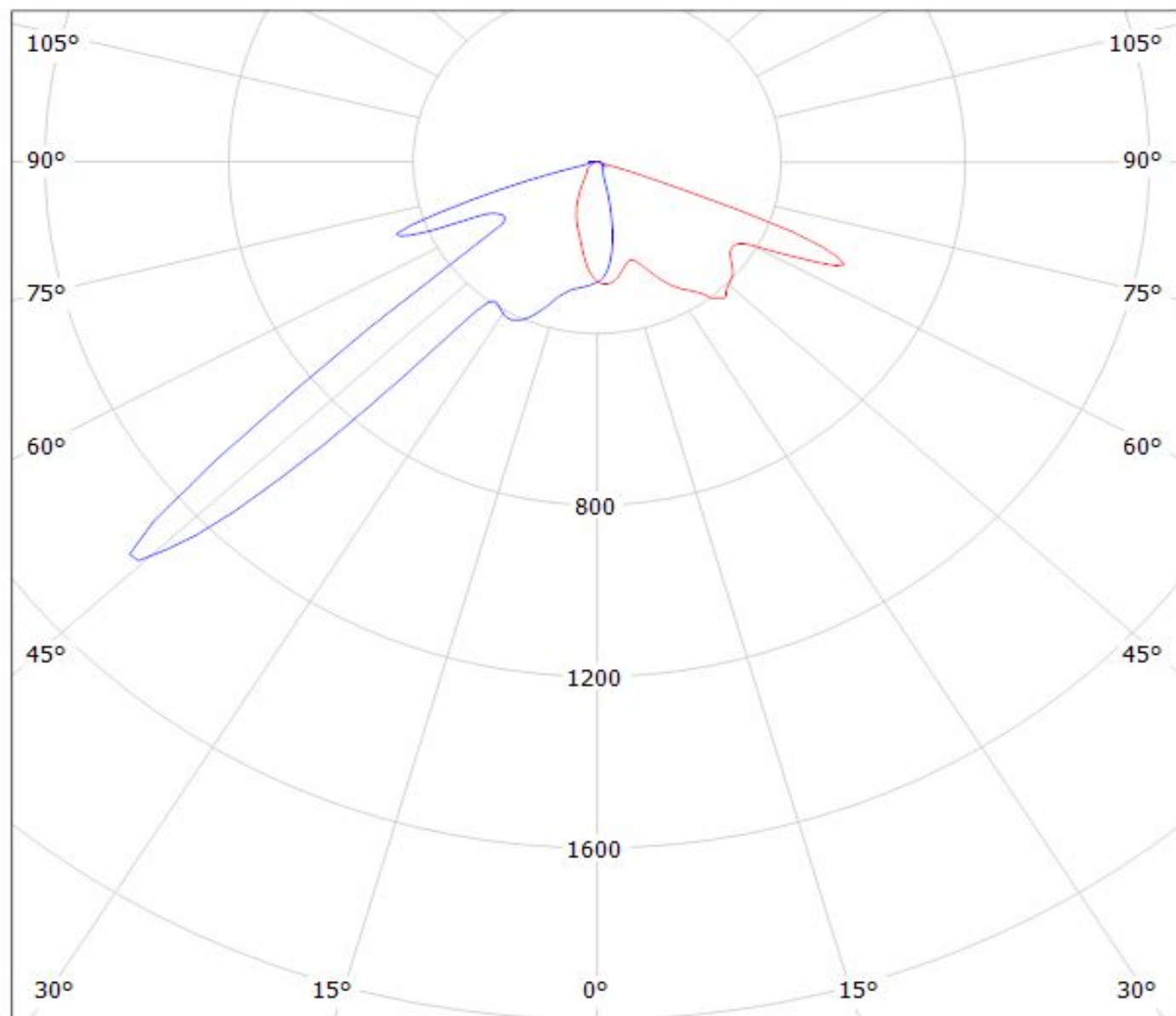

cd/klm

— C0 - C180

— C90 - C270

$\eta = 94\%$

Luminaire: LEDiL Oy C14116_STRADA-2X2-PX_(NCSxx19A)
Lamps: 1 x Nichia_NCSxx19A_(NCS119AT-H1)
_234.37lm@250mA_CCT=2830K_P=3.07452W_I=249.9mA

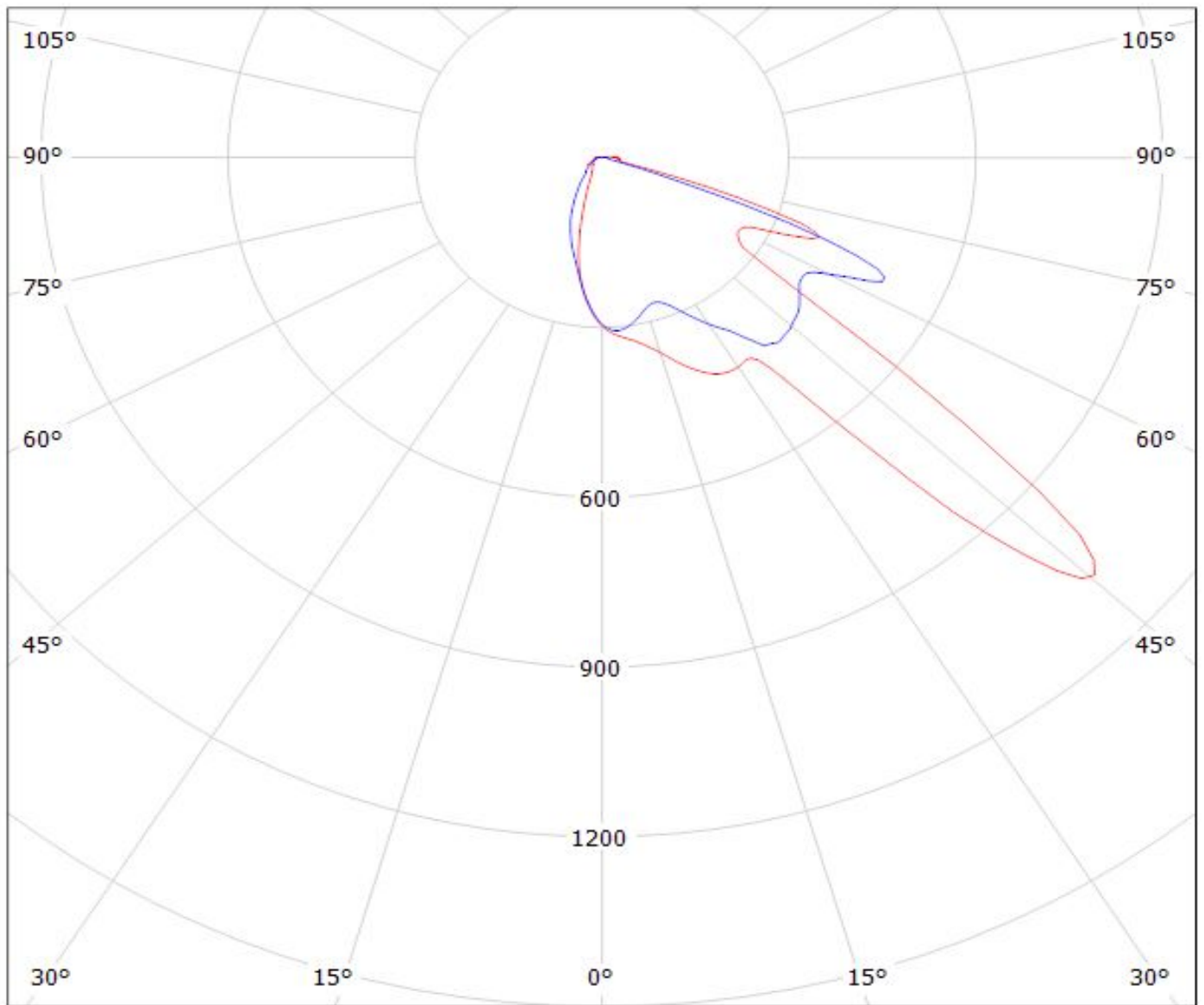

cd/klm

— C0 - C180 — C90 - C270

$\eta = 94\%$

Luminaire: LEDiL Oy C14116_STRADA-2X2-PX_(NVSxx19A)

Lamps: 1 x Nichia_NVsxx19A_(NVS219AT)_392.14lm@250mA_P=2.91991W_I=249.8mA

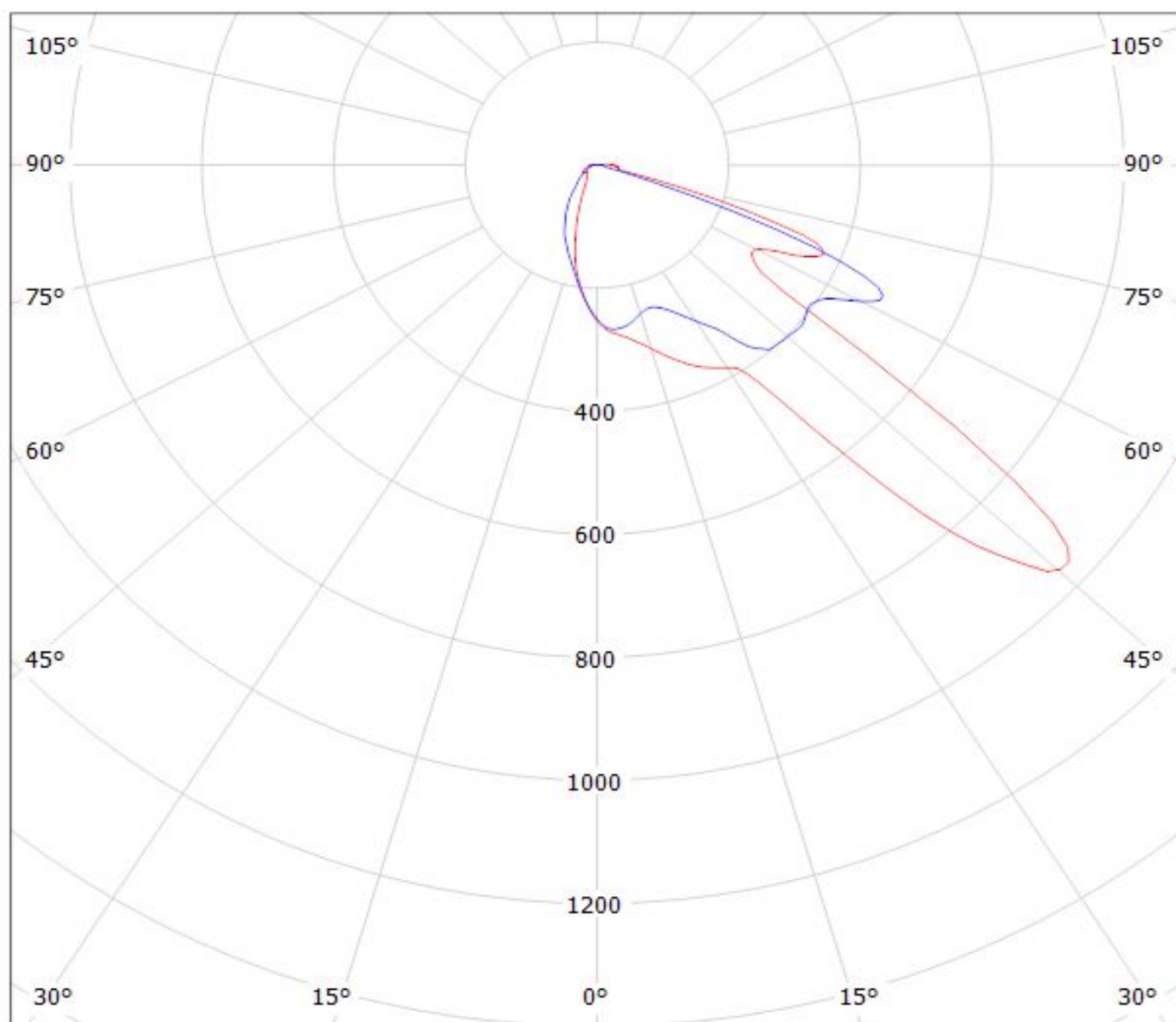

cd/klm

— C0 - C180

— C90 - C270

$\eta = 94\%$

Luminaire: LEDiL Oy C14116_STRADA-2X2-PX_(LUXEON_Q)

Lamps: 1 x LUXEON_Q_2x2_(LHQ-3080)_306.14lm@250mA_P=2.88419W_I=249.8mA

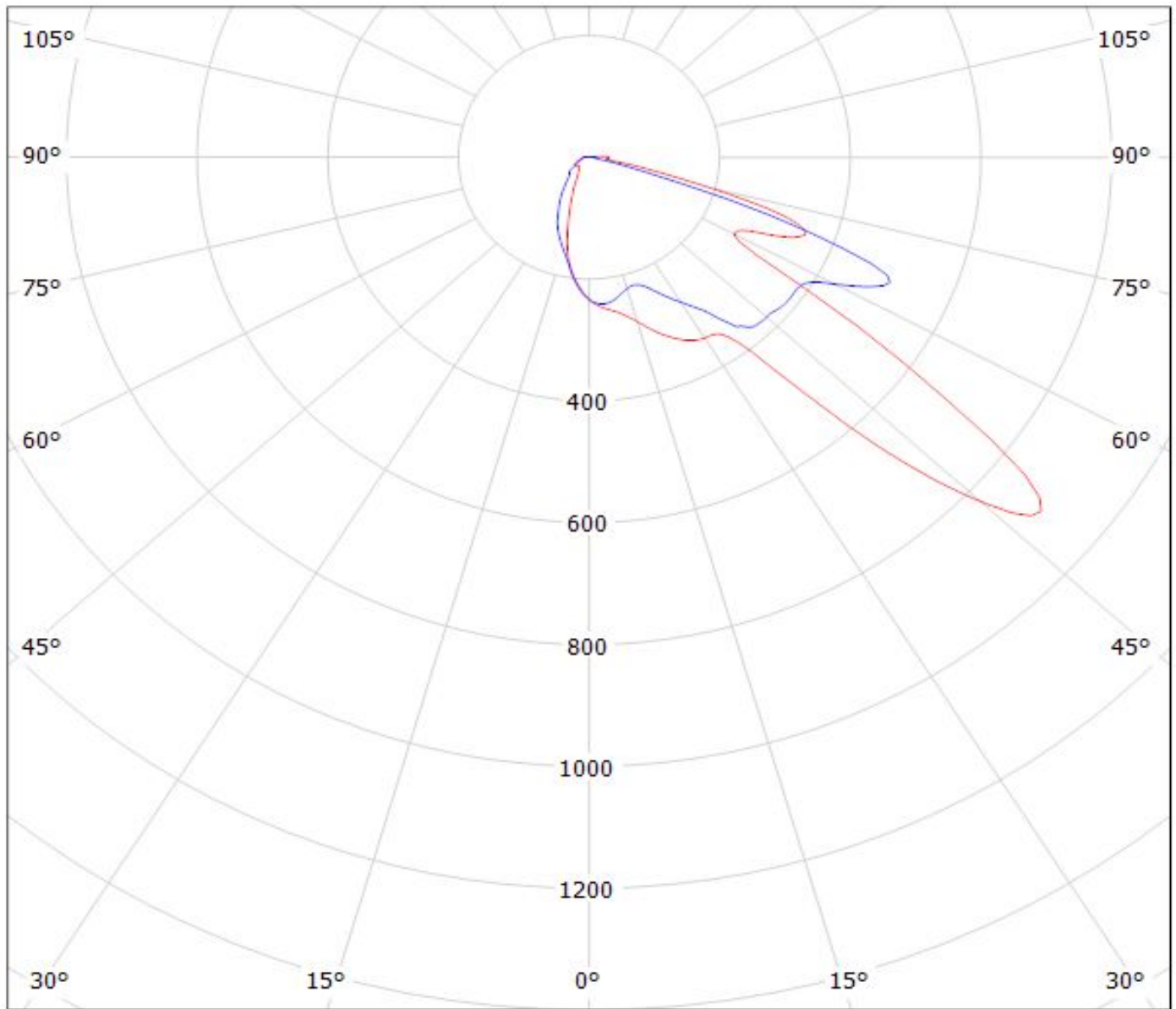

cd/klm

— C0 - C180

— C90 - C270

$\eta = 94\%$

Luminaire: LEDiL Oy C14116_STRADA-2X2-PX_(LUXEON_TX)

Lamps: 1 x LUXEON_TX_2x2_(L1T2-3585)_327.05lm@250mA_P=2.79476W_I=249.8mA

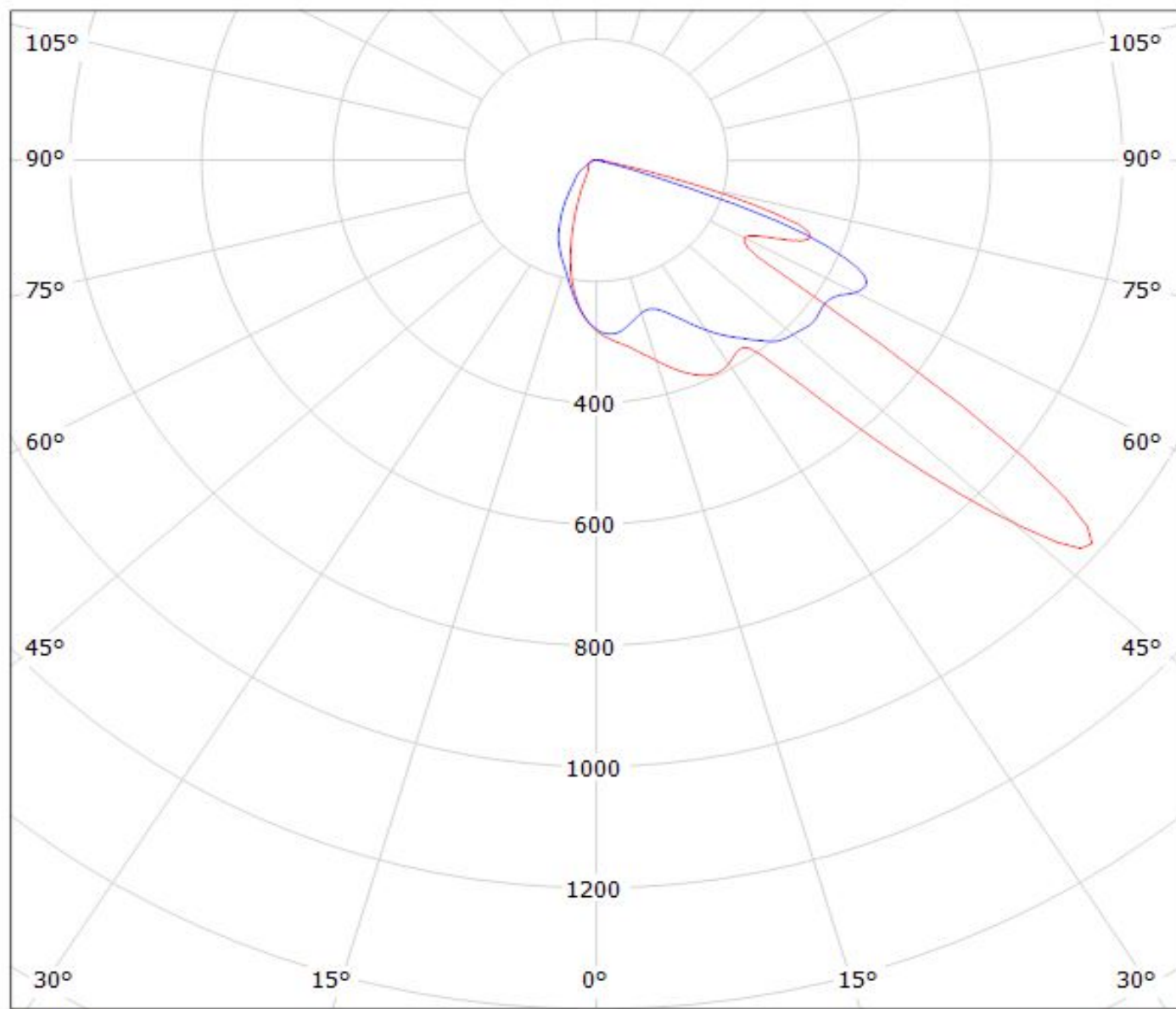

cd/klm

— C0 - C180

— C90 - C270

$\eta = 94\%$

NOTE: The typical divergence will be changed by different color, chip size and chip position tolerance. The typical total divergence is the full angle measured where the luminous intensity is half of the peak value.